

SitOnIt • Seating®

Price List October 17, 2022



TABLE OF CONTENTS

Intro

Sustainable Design.....	7
Ordering Information	8
Warranty	12
CAL 133.....	15
Fabric	17
COM/COL.....	18
COM/COL Test Request Form	19

Custom Upholstery Form.....	20
COM Calculation	21
COM/COL Yardage: Task and Conference.....	22
COM/COL Yardage: Multipurpose and Side	26
COM/COL Yardage: Lounge	29
Custom Finish Program.....	32

Task, Light Task, Executive and Conference Chairs and Stools

Amplify

Mesh Back Task Chair.....	38
Mesh Back Task Stool.....	42
Upholstered Back Task Chair.....	46
Upholstered Back Task Stool.....	50

Anytime

Light Task Chair and Stool	53
----------------------------------	----

Focus

Mesh Back Task Chair.....	56
Mesh Back Task Stool.....	61
Upholstered Back Task Chair.....	65
Upholstered Back Task Stool.....	70

Focus 2.0

Mesh Back Task Chair.....	74
Mesh Back Task Stool.....	79

Glove Active

Conference Chair	83
------------------------	----

Glove Executive

Conference Chair	87
------------------------	----

Hexy

Task and Conference Chair	90
Mesh Back Task Stool.....	94

InFlex

Light Task Chair and Stool	98
----------------------------------	----

Ioniq

Collaborative Chair.....	101
--------------------------	-----

Knack

Upholstered Back Task Chair.....	104
Upholstered Back Task Stool.....	108

Lumin

Light Task Chair and Stool	111
----------------------------------	-----

Mavic

Collaborative Chair.....	115
--------------------------	-----

Movi

Light Task Chair and Stool	118
----------------------------------	-----

Non-Stop Heavy Duty XL

Task Chair.....	121
Task Stool.....	124

Novo

Mesh Back Task Chair.....	127
Mesh Back Task Stool.....	132

OnCall

Light Task Chair and Task Stool	136
---------------------------------------	-----

Orbix

Light Task Chair and Stool	140
----------------------------------	-----

Prava

Conference Chair	143
------------------------	-----

ReAlign

Task Chair.....	147
Task Stool.....	152

Relay

Light Task Chair and Stool	156
----------------------------------	-----

Rio

Light Task Chair and Stool	160
----------------------------------	-----

Sona

Conference Chair	164
------------------------	-----

Torsa

Task Chair.....	168
-----------------	-----

TABLE OF CONTENTS

Task, Light Task, Executive and Conference Chairs and Stools

TR2		Wit	
Task and Executive Chair	172	Mesh Back Task Chair.....	184
Task Stool.....	176	Mesh Back Task Stool.....	188
Vectra		Thintex Back Task Chair.....	192
Mesh Back Task Chair.....	180	Thintex Back Task Stool.....	196

Multipurpose, Side and Guest Chairs ; Counter and Bar Stools

Achieve		Lumin	
Multipurpose Chair.....	204	Multipurpose Chair, Counter Stool and Bar Stool.....	246
Anytime		Mika	
Multipurpose Chair and Bar Stool.....	207	Multipurpose Chair, Counter Stool and Bar Stool.....	251
Baja		Movi	
Multipurpose Chair and Bar Stool.....	211	Nester Chair	255
Cora		OnCall	
Multipurpose Chair, Bariatric, Counter Stool and Bar Stool	216	Multipurpose Chair and Bar Stool.....	258
Cora		Orbix	
Replacement Seating Parts.....	221	Multipurpose Chair and Bar Stool.....	262
Focus Side		Qwiz	
Multipurpose Chair, Counter Stool and Bar Stool.....	222	Nester Chair	266
Freelance		Relay	
Multipurpose Chair, Counter Stool and Bar Stool.....	227	Multipurpose Chair.....	270
Bariatric Chair.....	233	Relay	
InFlex		Nester Chair	273
Multipurpose Chair, Counter Stool and Bar Stool.....	236	Rio	
Ioniq		Multipurpose Chair, Counter Stool and Bar Stool.....	276
Guest Chair	240	Rowdy	
Side Chair.....	242	Multipurpose Chair.....	280
Kickstand		Sprout	
Stool	244	Multipurpose Chair.....	283
		Wit Side	
		Mesh Back Multipurpose Chair.....	286
		Thintex Back Multipurpose Chair.....	289

TABLE OF CONTENTS

Lounge

Aviera

Guest and Bariatric Seating	299
Hip Chair	304
Patient Seating	308
Freespan Multiseating	313
Preconfigured Tandem Multiseating.....	318
Start/Center/End Tandem Multiseating	323
Linking Tables.....	328

Aviera

Replacement Seating Parts.....	331
--------------------------------	-----

Cameo

Seating and Benches	332
Inline and Coffee Tables	337

Composium

Curve Club Chair, Settee and Sofa	339
Flair Club Chair, Settee and Sofa	344
Sharp Club Chair, Settee and Sofa	349
Ottoman and Benches	354

Tables

Mezzanine

End Table, Coffee Table and Corner Table	409
Occasional Table	412

Ocala

Flip-Top Tables	415
Typicals.....	419

Parallon

Flip-Top and Fixed Top Training Table.....	423
Meeting, Café and Occasional Table	430

Surge

2-Leg Height-Adjustable Table.....	435
------------------------------------	-----

Benching

HiQ

Height-Adjustable Benching	488
----------------------------------	-----

Prise

Benching Typicals	500
Benching	505

Envoi

Lounge Seating	359
----------------------	-----

Gobi

Lounge Seating	363
----------------------	-----

Nano

Modular Lounge Typicals	366
-------------------------------	-----

Nano

Modular Lounge	372
----------------------	-----

Paséa

Modular Lounge Typicals	376
Modular Lounge Seating	381
Tables and Ottomans	389
Inline Tables.....	393

Visit Modular

Club Chair and Ottoman	396
------------------------------	-----

Switchback

2-Leg Height-Adjustable Table Bundle	439
2-Leg Height-Adjustable Table.....	445
3-Leg Height-Adjustable Table Typicals.....	450
3-Leg Height-Adjustable Table.....	453

Tensor

Café, Classroom, and Office Typicals	464
Café Table	467
Multipurpose Table.....	471
Desking	475

Uni

Laptop Table.....	485
-------------------	-----

Power Beam

EBEAM

Power + Data Beam	518
-------------------------	-----

TABLE OF CONTENTS

Screens

Doodle

Markerboard Worksurface Screen	526
--------------------------------------	-----

Modesty

Laminate Screens.....	529
-----------------------	-----

Motif

Fabric Worksurface Screen.....	531
Mobile + Freestanding Fabric Screen	537
Modesty Screen	540

Monitor Arms

King Cobra

Monitor Arm	562
-------------------	-----

Mobio

Monitor Arm	564
-------------------	-----

Accessories

Anti-Fatigue Mat.....	571
CPU Storage	572
Keyboard Tray	573
Laptop Storage	574
Rhythm.....	575

Mobile Pedestal

Appendix

Stand-Alone Tabletops.....	584
Super Duty Series Guide.....	591
Stacking Guide.....	594
Glide Guide.....	596
Care and Cleaning.....	597
Plastics Color Program.....	599

Sector

Acrylic Worksurface Screen	543
Mobile + Freestanding Acrylic Screen	546
Acrylic Seating Screen	548
Acrylic Café Screen	551
Acrylic Transaction Screen.....	553
Tri-Fold Acrylic Meeting and Single-Table Screen	555
Acrylic Modesty Screen	558

Unity G2

Monitor Arm	568
-------------------	-----

Storage Solution.....	576
Pencil Storage	578
Current	579
EON.....	580
High Tide.....	581
Cable Caddy	582

Mesh Color Program	600
Laminate Color Program	602
Mechanism Function Guide	609
Executive and Conference Chair Options	612
Multipurpose Chair Options	617

SitOnIt • Seating®

CALIFORNIA BORN AND BRED

We're a leading manufacturer of commercial solutions in the U.S.—and #1 in task chairs. From tables and lounge to screens and more, we've been the go-to destination for comprehensive, build-to-order solutions for almost 25 years.

We combine award-winning design with the fastest lead times around (choose from 2-, 5- or 10-day shipping). We can build almost any specification you want, deliver it when you need it and offer a price no one can match. It's all part of our indie California spirit and drive to help you do more.

DESIGN THAT GETS YOU

Discover seating engineered around you. Experience responsive design, supreme comfort and hyper-customizable features—all at value-driven prices.

OUR BUILD-TO-ORDER PROMISE

Custom-designed chairs, no waiting. Our nimble size and lean manufacturing operation means we can ship build-to-order chairs in just two days.

FASTEST SHIPPING IN THE INDUSTRY

Choose from two, five, or 10 day shipping. We cut lead time, sync orders and avoid off-schedule shipments at a rate our competitors just can't match.

WORLD-CLASS SERVICE

We're proud to announce that the Office Furniture Dealer Alliance voted for us as "Best Customer Service" three times in the past five years.

SUSTAINABLE DESIGN

We make it easy to go green. Design an eco-friendly room from the ground up or upgrade an existing space to meet the latest environmental standards.



ANSI/BIFMA Certified

SitOnIt Seating is a member of the Business and Institutional Furniture Manufacturer's Association (BIFMA). Tests developed by BIFMA are approved by the American National Standards Institute (ANSI) to determine the strength and durability of seating. Although testing is not a warranty or guarantee, our task, side and lounge products meet or exceed BIFMA and ANSI standards.



LEED Certified

Earn points toward LEED certification thanks to our U.S. manufacturing location and our use of recycled materials where possible.



GREENGUARD Certification

All SitOnIt Seating lounge and seating products met the rigorous criteria required by GREENGUARD in accordance with the Collaborative for High Performance Schools.



LEVEL Certified

Sustainability matters. That's why we've worked to achieve BIFMA LEVEL® certification for all task chairs, side chairs and lounge products.



The Take Back Program

SitOnIt Seating helps minimize product waste by connecting our customers and dealers with third-party groups who redirect materials that would be headed for the landfill to local nonprofits and public agencies.



We Did Our Homework

Download detailed documents that break down the percentage of recycled content, manufacturing processes and indoor air emissions for every chair we make.

ORDERING INFORMATION

Pricing

All prices are suggested retail and are subject to change without notice. Visit our websites or contact Customer Experience for the latest pricing. Prices in effect at the time of shipment will prevail. We reserve the right to make changes in prices, models, fabrics, finishes, materials and specifications and also discontinue models and options at any time without notice.

Orders

Specify model number, quantity, desired delivery date and all other applicable information. Order templates can be found in the applicable Price Guide. Orders will be accepted with an acknowledgment form governing the transaction. In the event an error is made in the manufacture of the product, the acknowledgment will be used as the resolution document. Submit orders by email or fax:

SITONIT SEATING:

Email: purchaseorder@exemplis.com

Fax: (714) 995-4855

Minimums

FREIGHT PROGRAM

The freight program is designed to deliver freight prepaid to the designated consignee. To offset rapidly increasing costs, it requires a minimum quantity (three or more items) for select product categories. Premium freight services and/or guaranteed delivery may result in additional shipping charges.

NO MINIMUM REQUIREMENT:

- Task/Collaborative/Conference/Executive seating and task stools
- Side, nesting seating and stools
- Plastic seating
- Height adjustable tables (except tops)*
- Fixed and adjustable benches (except tops)*
- Power beam
- Training/meeting/Café/Occasional tables (except tops)*
- Ergonomic accessories (e.g. monitor arms, keyboard trays, wire management, desktop sit-to-stand, anti fatigue mats, power solutions)
- Screens
- Storage
- WFH products

Note: The tops for these products will have a minimum requirement of four units. Uni table ships in a single packet and the top is not subject to minimum four rule.

Minimums (Cont.)

3-UNIT MINIMUM:

- Lounge seating
- Tandem seating (Aviera)

Note: Products that do not require a minimum can be combined with those that require 3-unit minimum to reach the minimum quantity. If the minimum is not met, the order will incur a \$95 net surcharge per order.

4-UNIT MINIMUM:

- Tabletops/worksurfaces

Note: Tabletop/worksurface orders that don't reach the minimum of 4 tops will incur a \$95 net surcharge per order even if they're part of a larger order.

EXAMPLES

- Order A: 1 Rio chair, 1 Wit chair, 1 Gobi – no surcharge
- Order B: 1 Gobi, 1 Envoi - \$95 surcharge because the number of lounges is less than minimum 3 and there are no other products in the order
- Order C: 1 Aviera, 1 Mobio arm, 1 Motif screen – no surcharge
- Order D: 1 eBeam, 1 EON, 1 Switchback base, 1 Switchback top - \$95 surcharge because the number of tops is under the required four tops minimum
- Order E: 3 Switchback tables with tops - \$95 surcharge because the number of tops is under the required four tops minimum

Quantity Discounts

Quantity discounts for CAL 133 textiles and some shipping methods are available. See the appropriate Price Guide or contact Customer Experience for more information.

Change Orders

Orders that have been scheduled for production may not be changed. All changes on customer orders previously acknowledged must be requested in writing and are subject to approval. Requests for changes are not deemed accepted until acknowledged. In the event a revision is accepted, change fees may apply.

ORDERING INFORMATION

Lead Time

We have thousands of carded textiles—including vinyl and leather—that ship in two, five or 10 days. For a complete listing of textile lead times, see the Carded Textile Program section of the [Textile Reference Guide](#) or visit the [Materials tab](#) on our websites. Graded-in, COM and COL orders start production when the textile arrives from the manufacturer. Because of this the lead time on Motif screens or upholstered chairs is two, five or 10 days based on the textile selection.

TWO-DAY

- Anti-Fatigue Mat
- Corner Sleeve
- CPU Holders
- Current power
- High Tide
- Keyboard Mechanisms (Lift and Lock, Premium Lift and Lock, Sit-to-Stand)
- Keyboard Trays (Longboard, Crescent Board, Mini Platform, Laptop Tray, Adapter)
- Laptop Drawer
- Mobile Pedestals
- Monitor Arms
- Ocala Bases
- Pencil Storage
- Plastic Shells
- Switchback Bases
- Tensor Bases
- Value Lighting
- Voyager 2-Stage/3-Leg Bases
- Wire Management

THREE-DAY

- Doodle Screens
- Mobile Pedestal Cushions
- Modesty Screens
- Motif Screens
- Parallon Tables
- Prise Benching
- Sector Screens
- Standard Worksurfaces

10-DAY

- Lounge

15-DAY

- Stain-to-Match

21-DAY

- Tablet Arm

30-DAY

- Custom Laminate

Hold

Orders received by 10 a.m. PST begin assembly the next day. Orders that are “On Hold” will begin production only when all holds are released. Customer Experience will notify you of any holds placed on your order.

Types of holds include:

- Credit Hold for issues related to billing and invoicing.
- Incomplete Hold if the purchase order is incomplete or illegible.
- Pricing Hold if the price on the purchase order does not match the pricing shown in the Price Guide or in our computer system.
- New Fabric Hold for nonstandard textile orders without an inventory part number.
- Graded Hold is placed by the Purchasing Department while confirming delivery of graded fabric from the vendor.

Large Orders

Large orders may require additional lead time:

25 UNITS

- Cameo
- Composium
- Envoi
- Gobi
- Nano
- Paséa
- Visit Modular

50 UNITS

- Aviera
- Benching
- Screens
- Surge Bases
- Tabletops
- Tensor Bases
- Parallon Bases

150 UNITS

- Accessories
- Switchback Bases
- Lighting
- Monitor Arms
- Ocala Bases
- Power
- Sit-Stand (Desktop)

250 UNITS

- Task Chairs/Stools
- Side Chairs/Stools

ORDERING INFORMATION

Product Modification

Special requests are available and additional charges will be determined per quotation. Up to five working days are required after the special request is received to prepare a quotation. Contact Customer Experience for details.

Orders for Parts

Multiple shipments may occur for orders that include parts. Hardware such as casters or cylinders will ship separately from items requiring upholstery or manufacturing labor. Components such as casters or cylinders will ship separately from new chairs.

Product and Design Changes

We reserve the right to discontinue product lines, models and parts at any time. We also reserve the right to make changes in design and material when such action is deemed to be an improvement in design, function and/or construction.

Cancellation and Returns

Orders that have entered any stage of production cannot be canceled. Request for cancellations are not accepted until acknowledged. In the event a cancellation is accepted, canceled charges may be imposed for the entire amount of the order. Authorization for return must be requested from and approved by Customer Experience prior to the return of the merchandise. Returns may be subject to a restocking charge equivalent to 40% of the net order plus freight. Unauthorized returns will not be accepted.

Shipping

Standard shipments are made via common carrier, unless otherwise specified. Special routing requests made by the customer or the consignee may result in additional charges.

Standard deliveries are dock-to-dock and are scheduled to occur Monday through Friday between 8 a.m. and 5 p.m., based on our published transit times. We will not be held responsible for issues or costs arising from carrier transit delays, missed delivery appointments, etc.

We reserve the right to charge for nonstandard customer delivery requirements that may include order deliveries, inside deliveries, etc. For information concerning these charges, contact Customer Experience.

Freight Terms

Freight terms apply to the continental U.S. only. This excludes Alaska and Hawaii. All standard transportation services and freight costs are included in the price of our products. We ship freight prepaid and allowed, FOB and origin.

Shipments outside the contiguous U.S. are shipped to the point of embarkation free of charge, if the shipment meets the minimum requirement. All subsequent freight charges will be at the customer's expense, shipped collect.

Because of the fluctuation of fuel prices, we reserve the right to impose fuel surcharges for any shipments.

Freight Damage

We are not responsible for product damage occurring in transit or during storage. Before accepting a shipment from the carrier, carefully review the packing list and inspect the quantity and condition of the items. Promptly document all visible damage on the Bill of Lading and request a carrier inspection of the product. In the event of damage, accept the order and contact Customer Experience for issue resolution. Concealed damage must be reported in writing within 60 days of accepting delivery. We will take all reasonable steps to assist customers in resolving claims for loss or damage.

Smart Delivery

Smart Delivery provides precise order delivery within a customer-specified date and time window. This special service is available in the contiguous U.S. and includes inside delivery, non-dock delivery, weekend delivery and residential delivery.

Requests must be made prior to an order being scheduled for production. A Smart Delivery fee will be added to the original order invoice. Any changes to a submitted Smart Delivery order will require a new Smart Delivery quote request. Not all change requests can be honored. Changes to an order will result in delays and/or additional costs once the order is in transit.

The Smart Delivery fee will be refunded if the shipment does not arrive within the specified delivery window. We will not be held responsible for costs or damages associated with delayed deliveries.

Please contact Customer Experience to request a Smart Delivery quote or for more information.

Will Call

Customers with Will Call orders will be notified once orders are ready to be picked up. Customers will have three business days from notification to pick up the order. If the order is not picked up within this time frame, storage charges will start at a rate of \$30 per business day until the order has been claimed.

Invoicing

Invoicing is triggered when the product ships.

WARRANTY

Product Warranty Periods

Exemplis LLC, d.b.a. SitOnIt Seating (hereafter referred to as the Company), warrants to the original end user that this product will be free from defects in its material and workmanship when used in a single shift (standard eight-hour day, five days per week) for the following warranty periods:

LIFETIME WARRANTY COVERAGE:

- All SitOnIt Seating products, except where noted below
- Structural Components: eBEAM, HiQ, Parallon, Prise, Surge, Switchback and Voyager

12-YEAR WARRANTY COVERAGE:

- Amplify, Cora (Guest, Hip and Stool), Novo, Torsa, and Wit used in multi-shift (24/7) applications
- Lounge seating and occasional/lounge tables
- Bases: Ocala, Tensor
- Laminate tops
- Monitor arms¹: King Cobra, Mobio series, Unity G2
- Plastic shells

10-YEAR WARRANTY COVERAGE:

- Non-Stop Heavy Duty, Cora (Midsize and Bariatric), Freelance Bariatric and chairs purchased with a Heavy Duty (HD) or Large and Tall (LT) option used in multi-shift (24/7) applications
- Electrical Components: eBEAM, HiQ, Parallon, Prise, Surge and Switchback

FIVE-YEAR WARRANTY COVERAGE:

- Fabric, foam, knit back, and mesh
- All filing products³
- CPU holders
- Screens⁴
- High Tide
- Keyboard trays
- Lighting fixtures
- Power components⁵: EON, Current, Power Strips
- Wire management

TWO-YEAR WARRANTY COVERAGE:

- Fabric and foam cushioning for Non-Stop Heavy Duty, Freelance Heavy Duty, Cora Midsize and Bariatric and chairs purchased with an HD or LT option
- Multipurpose felt glides
- Half-Moon Pencil Drawer

ONE-YEAR WARRANTY COVERAGE:

- Lighting power supplies
- Mouse pads
- Wrist rests

1. Weight capacity of the monitor arms must be followed. If an arm is not functioning properly because of the weight of the monitor is outside of the advertised weight capacity, the monitor arm will not be considered defective under the warranty.

2. Please note that electrical components on a height-adjustable table include: hand controls, motors, control boxes and electrical cables.

3. This warranty does not cover damage from ordinary wear and tear, including paint finish changes and/or discoloration resulting from aging or exposure to light.

4. Warranty limited to finishes, tacking surface of tack boards and writing surface of whiteboards. Standard textiles limited to original manufacturer's warranty.

5. Power components are defined as any power unit with electrical outlets and/or USB/data connections, connector jumper cables for daisy chain and infeeds for hardwire applications.

WARRANTY

Freight Warranty

At SitOnIt Seating™, we take pride in crafting one-of-a-kind pieces. Products are thoughtfully inspected prior to being carefully wrapped and packed for shipment. Upon receiving your order, should your order be less than perfect, please follow these steps for an expedited resolution:

IF DAMAGE IS VISIBLE:

- Please accept shipment and report damages on the freight bill.
- Contact SitOnIt Seating Customer Experience to report the issue **within 10 days** after delivery.

IF DAMAGE IS CONCEALED:

- Save merchandise and packaging.
- Take a photo to document the damage.
- Contact SitOnIt Seating Customer Experience to report the issue **within 60 days** after delivery.

Either way, we are here to help! SitOnIt Seating Customer Experience Team is on standby to assist Monday through Friday, 5:00 a.m. to 5:00 p.m. PST. Call (888) 274-8664 or email sitonit@exemplis.com.

The Company Does Not Warranty

- COM/COL textiles
- Product abuse or misuse
- Failure resulting from normal wear and tear
- User modification of or attachments to the product
- Products or parts not used, maintained or installed in accordance with the Company's installation, maintenance and/or applicable guidelines
- Products that are exposed to extreme environmental conditions and/or have been subject to improper storage
- Floor samples or display models
- The substitution or use of non-SitOnIt Seating components with SitOnIt Seating products
- Products purchased "as is" and/or secondhand
- Products sold by unauthorized dealers
- Creasing and/or gathering of textiles during upholstery application process
- Minor irregularities of color, surface, grain and texture
- Minor variations of color in textiles
- Variations of texture and natural markings such as neck wrinkles, scratches, backbone marks and stretch marks in leather
- Color matching of textiles exactly to samples, swatches or prior purchases

For orders shipping outside the contiguous 48 U.S. states or the common provinces of Canada (British Columbia, Alberta, Saskatchewan, Manitoba, Ontario, Quebec, New Brunswick & Nova Scotia), we will provide replacement parts and pre-approved labor as determined by our warranty team. However, matching our standard freight policy, we will only ship those replacement parts to a U.S. port. It is up to our dealer to handle freight costs from the U.S. port to their location.

WARRANTY

Applicable Provisions To All Products And Services

The Company will repair or replace with a comparable product, at its option, without charge to the original purchaser, only defective products or parts found defective during the Warranty Period. If requested by the Company, the original purchaser must return the part or product with freight or other shipping charges prepaid.

This warranty shall be effective for the applicable time period beginning from date of purchase as shown on original purchaser's original receipt or other proof of purchase.

For products purchased on or after August 1, 2012, the Company shall pay for all labor costs pre-approved by the Company. The payment of such pre-approved labor costs will be in the form of a credit to an active Company account.

There are no other warranties, expressed or implied, other than those specifically described, including, without limitations, any implied warranty or merchantability or of fitness for a particular purpose. The Company will not be responsible for incidental or consequential damages. Some states do not allow the exclusion or limitation of incidental or consequential damages, so the above limitations or exclusions may not apply to you. This warranty gives you specific legal rights and you may have other rights which vary from state to state.

Warranty claims must be reported within 60 days of any concealed damage. The Company will advise you of the procedure to follow when making warranty claims. Call the Company at the number below to explain the defect. Give your name, address and telephone number. Please be prepared with the model number and sales order number found under the seat of the chair.

SitOnIt Seating: (888) 274-8664

Fire safety is a top priority for us. SitOnIt Seating strongly supports CAL 133 standards and makes it easy for designers and buyers to specify CAL 133 chairs.

TB 117

Under California law, all upholstered furniture must meet TB 117-2013 by January 1, 2015. At a minimum, all SitOnIt Seating fabrics, vinyl, leathers and resilient filling material (i.e., foam and Dacron) meet TB 117-2013. Unlike TB 117-2013, which tests only the inner upholstery components, with CAL 133 the entire piece of furniture must withstand ignition from a gas burner inside a testing chamber.

What is CAL 133?

CAL 133 is a standard of furniture flammability started by the California Bureau of Home Furnishings and Thermal Insulation for furniture used in public buildings such as healthcare facilities, convalescent homes, public assembly areas of hotels and motels, hospitals, board and care homes, stadiums, licensed child care facilities, prisons and jails.

Notice: Starting January 1, 2020, the State of California changed regulations to ban flame retardants in upholstered furniture sold in California. We anticipate further regulatory changes in other states. The TB-133 barrier material used in our products is a flame-retardant fabric designed to pass open-flame testing protocols. The cotton/fiberglass knit is infused with a phosphorus flame retardant and coated with a chemical that expands in heat to create a physical flame barrier. The TB-133 barrier material that we use in our products is free of halogenated flame retardants, polybrominated diphenyl ethers (PBDE), formaldehyde, and antimony.

Choosing CAL 133 Textiles

Consult the individual [SitOnIt Seating fabric cards](#) to review the specifications for each fabric offered. Because we offer such a vast array of fabrics with varying degrees of flame retardancy, we suggest you consult the published technical data of the fabric supplier when making your fabric selection.

Specify CAL 133 textiles in the Material section of the Final Price Calculation worksheet or on your purchase order.

SitOnIt Seating assumes no responsibility for the flame retardancy of any customer-provided textile.

CAL 133 Testing

CAL 133 is a full-scale fire test for furniture manufactured for use in public buildings. The standards do not specify how to construct furniture, but only how it should perform when tested. To pass this fire standard test, a fire blocking liner is sandwiched between the foam and the fabric of our chairs. This liner acts as a fire extinguisher by smothering the flame.

COM/COL compliance for the CAL 133 models listed on the following page can be determined by specifying upholstery with the exact characteristics as approved SitOnIt Seating fabrics and leathers or by conducting a full chair burn test. The nondiscountable test fee for each chair-textile combination is listed below. The lead time for testing is four weeks.

Task and Side Chairs/Stools: \$600
Lounge: \$800

For more information on TB 117-2013 and CAL 133, visit the [State of California Department of Consumer Affairs](#) website.

To Order CAL 133

Allow a 10-day lead time. Clearly specify CAL 133 on your order. For each chair, add the appropriate additional charge.

CAL 133 Materials

- **CAL 133 LEATHER:** All carded leather is CAL 133 approved.
- **CAL 133 PLASTIC:** All our plastic chairs are CAL 133 approved except for our Achieve and Baja collections.
- **CAL 133 TEXTILES:** Over a thousand CAL 133 approved textiles in all grades, colors and styles are listed on the SitOnIt Seating website. Visit sitonit.net and search textiles by CAL 133 compliance, manufacturer, grade, lead time and other attributes.

To Check Seating for CAL 133

To determine whether your current SitOnIt Seating chair meets CAL 133, or to check an order you have recently received, check the bottom of the chair seat pan for the label shown below. If your chair does not have this tag, your chair does not meet CAL 133.

NOTICE

This Article is manufactured for use in public occupancies and meets the flammability requirement of California Bureau of Home Furnishings technical bulletin 133. Care should be exercised near open flame or with burning cigarettes.

CAL 133 Approved Models

The following models, when combined with approved textiles and blocker, meet the CAL 133 standard.

MULTIPURPOSE CHAIRS AND STOOLS

- Achieve: Upholstered
- Anytime: Upholstered and all plastic colors - A48, A49 (arm and armless)
- Focus Side: Upholstered and all mesh colors - A130 (arm and armless)
- Freelance: Upholstered and all plastic colors (arm and armless)
- InFlex: Upholstered and all plastic colors: A121, A122 (arm and armless)
- Lumin: Upholstered and all plastic colors
- Mika: All models
- Movi: All mesh colors
- Non-Stop Heavy Duty: A67, A68, A69, A70, A71, A72 (arm and armless)
- OnCall: Upholstered and all plastic colors - A37FR, A42FR (arm and armless)
- Qwiz: All models
- ReAlign: A73, A74, A75, A76, A77 (arm and armless)
- Relay: Upholstered and all plastic colors - A60, A61 (arm and armless)
- Rio: Upholstered and all plastic colors (arm and armless)
- Rowdy: Upholstered and all plastic colors - A47 (arm and armless)
- Wit Side: All mesh colors (arm and armless)

CAL 133 Approved Models

TASK CHAIRS AND STOOLS

- Amplify: Upholstered and all mesh colors
- Focus: A91, A92, A93, A94, A95 (arm and armless)
- Knack: A77, A80, A81 (arm and armless)
- Mavic: All models
- Novo: All mesh colors (arm and armless)
- Prava: A105, A106, A108, A109, A111, A112 (arm and armless)
- Sona: A101, A102, A105, A106, A108, A109 and all knit colors (arm and armless)
- Torsa: All mesh colors (arm and armless)
- TR2: A12FR, A15FR, A17FR, A43FR, A44FR (arm and armless)
- Wit: All mesh colors (arm and armless)

LOUNGE SEATING

- Aviera: Metal and Wood
- Cameo
- Composium
- Envoi
- Gobi
- Nano
- Paséa
- Visit Modular

Unmatched Matching®

Textiles can be everything. With the right fabrics, you can provide atmosphere, create cohesiveness and offer an unforgettable experience across many spaces and places.

Fabric color, alignment, texture, orientation and pattern all play a part—and need to line up or match perfectly (especially with field-replaceable parts). With PatternMatch and pattern orientation, you can rest assured that every part of every chair can be traded out easily without disrupting design.

PatternMatch®

We ensure that design elements of the back, seat and arms match and/or align between seat and back. The patterns or lines also match unit-to-unit.

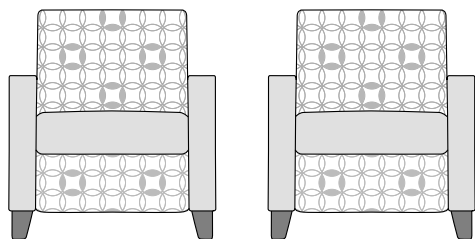

Pattern Orientation

All fabric (vertical, horizontal or bi-directional pattern) will be applied in the direction shown on the fabric manufacturer's website, unless otherwise specified.

To ensure desired fabric direction, use the Custom Upholstery Order Form on page 20 and check the appropriate box under the "Pattern Orientation" section.

When we apply a textile pattern with lines at a 90-degree angle (vertically and/or horizontally) to the back and seat of a chair, we strive to achieve full alignment. Some small variations can occur due to the shape and size of the product. Pattern Orientation is standard for SitOnIt Seating.

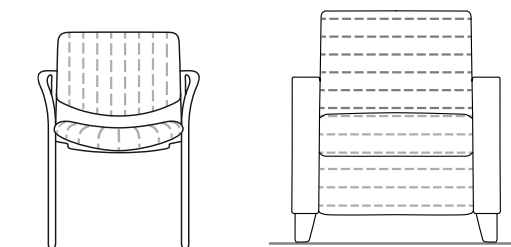

Multi-Upholstery

The multi-upholstery option allows one fabric to be selected for the back and a different fabric for the seat. Multi-upholstery lounge pricing is different than multi-upholstery pricing for task and side seating.

TASK AND SIDE

- Upholstery pricing is based on both seat and back being the same textile. If the material is COM/COL or more than one textile is used:

If two fabrics of the same grade are chosen, one grade level will be added to the upholstery price.

Example: grade 4 for the seat and a different grade 4 for the back, the upholstery price will be grade 5 for both.

If two fabrics of different grades are chosen, the final upholstery price will be based on the highest grade. Example: grade 2 for the seat and grade 3 for the back, the upholstery price will be grade 3 for both.

The above upcharges only apply to chairs that have both the seat and back upholstered.

LOUNGE AND CORA

- A standard upcharge applies to all multi-upholstery orders. Different fabrics and grades may be combined because each back, seat, arm and valance are separately priced.
- Add the single multi-upholstery upcharge to the cost of the components. Example: upcharge + any grade price for the seat + any grade price for the back + any grade price for the arm.

Moisture Barrier

Accidents happen. To help protect your investment, moisture barrier for seats and backs is an option on all lounge seating products.

Specify moisture barrier seats and/or backs in the Material section of the Final Price Calculation worksheet or on your purchase order. Note that specification and pricing are separate for seat and back and apply to each single seat or back position.

COM/COL Warranty

Any textiles applied to furniture orders through the COM/COL process will not be covered under warranty by SitOnIt Seating. Any warranty claims for these upholstery materials will fall to the original vendor of the fabric. With a broad spectrum of harsh cleaning agents used by facilities, SitOnIt Seating recommends that the owner test each fabric selection with their specific cleaning methods before using. Additionally, SitOnIt Seating is not held responsible for receipt of defective fabrics, as we apply all COM as first-quality goods.

CAL 117 Policy

SitOnIt Seating assumes no responsibility for the fire retardancy of any COM/COL. Customers are solely responsible for making sure that their COM/COL complies with all applicable codes and regulations. For information on CAL 133, refer to page .

COM/COM Excess Yardage

SitOnIt Seating is not responsible for yardage submitted to us beyond the required amount. Excess COM/COL materials will be discarded at the discretion of SitOnIt Seating unless otherwise instructed by the customer at the time the order is placed. If a customer requires the COM/COL excess yardage returned, they must contact Customer Experience to make arrangements. The customer will be responsible for delivery charges.

COM/COL Process

1. Visit the [SitOnIt Seating Textile Compatibility](#) tab on our website to see if your COM/COL textile has already been approved.

(If your textile is already approved, skip to step 3. If it hasn't been previously approved, go to step 2.)
2. Send a 12" x 12" textile swatch to be tested for approval along with a completed COM/COL Test Request Form found on the next page.

Note: Cora, Freelance back, InFlex back, Focus Side back and Achieve back require 0.75 yards of fabric to be sent for testing.

Allow two business days once your textile is received for the test results to be available on the [SitOnIt Seating Textile Compatibility](#) tab on our website.

Send the textile swatch and form to:

SITONIT SEATING
Attn: COM Engineer
6280 Artesia Blvd.
Buena Park, CA 90620

3. If the COM/COL swatch is approved, fill out the Customer Upholstery Form located on page page 20. and attach with your order.
4. Ship the necessary amount of COM or COL material and the purchase order number to:

SITONIT SEATING
Attn: COM Engineer
6280 Artesia Blvd.
Buena Park, CA 90620

COM/COL TEST REQUEST FORM

Please complete one form for each model and/or textile that needs to be tested.

Contact Information

Dealer _____ Contact Name _____

Address _____ City _____ State _____ Zip _____

Phone _____ Fax _____ Email _____

Product Information

Product Name _____ Model Number _____

Textile Information

Manufacturer _____ Pattern _____ Colorway _____

Shipping Information

The 12" x 12" textile swatch and this form can be sent to:

SITONIT SEATING

Attention: COM Engineer
6280 Artesia Blvd.
Buena Park, CA 90620

Please allow five business days once the fabric is delivered for your test results to be available on the [SitOnIt Seating Textile Compatibility](#) tab of our website. If you need further assistance, please contact Customer Experience at (888) 274-8664.

Note: Freelance back, InFlex back, Focus Side back and Achieve back require 0.75 yards of fabric to be sent for testing. Motif requires 1.5 yards of fabric to be sent for testing.

CUSTOM UPHOLSTERY FORM

For all COM/COL orders or standard orders with custom textile upholstery directions, please complete one form for each model and/or textile.

Contact Information

Dealer _____
 Address _____
 Phone _____ Fax _____

Contact Name _____
 City _____ State _____ Zip _____
 Email _____

Order Information

Purchase Order Number _____ Sales Order Number _____

Product Information

Product Name _____ Model Number _____ Quantity _____

Textile Information

Manufacturer _____ Pattern _____ Colorway _____

Total Yardage Shipped (for COM/COL) _____
 (To calculate, reference COM Calculation and COM Yardage Requirement beginning on page 21.)

Contains flame retardants: Yes No

Prop 65 compliant: Yes No
 PFAS compliant (AB1817): Yes No

Per California Proposition 65, we are required to note that select textiles may contain chemicals known to cause cancer or reproductive toxicity. To learn more, please visit the [Prop 65 web page](#).

Fabric Direction

To avoid confusion, you may wish to attach a sample textile with the desired face and direction indicated. Is there a desired top and bottom to the fabric application?

Yes No

Is the fabric either a stripe or two-color plaid?

Yes No

Please refer to our standard and rotated fabric directions to the right. Indicate the desired fabric direction for each applicable component below.

Seat (Ottoman Chassis): Vertical Horizontal
Back (Ottoman Top): Vertical Horizontal
Arm: Vertical Horizontal
Valance: Vertical Horizontal

Please attach this form with your order submission.
 If you are submitting a COM/COL order, make sure to include your PO# with the textile that you mail to our factory:

SITONIT SEATING

Attn: COM Engineer
 6280 Artesia Blvd.,
 Buena Park, CA 90620

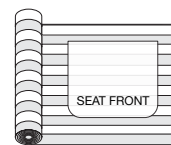
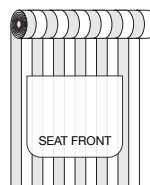

Vertical or Off the Roll

Horizontal or Railroaded

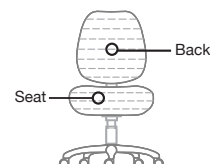
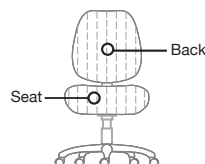
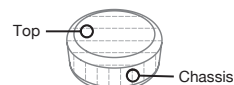
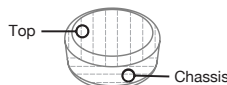
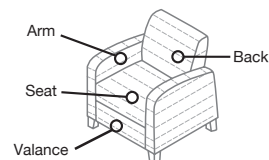
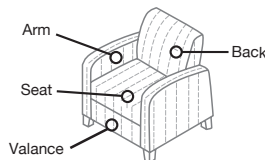

COM CALCULATION

Steps to Calculate COM Yardage.

1. Determine which products are being ordered as COM.
2. Find the yardage needed to upholster those products from the COM Yardage Requirement charts.
3. Adjust the yardage requirement total based on the repeat of the fabric roll using the COM Repeat Calculation table.
4. Take the final calculation and round up to the nearest half-yard to get final yardage.

For orders of 10 or more seats, contact Customer Experience for further quoting.

COM Repeat Calculation.

Use the guide below to calculate the percentage of extra upholstery required to cover large repeats.

Repeat	Railroaded/Horizontal OR Vertical/Off The Roll
5.1"– 7"	10%
7.1"–10"	15%
10.1"–14"	20%
14.1"–20"	30%
20.1"–27"	45%

Yardage requirements listed in this document are based on textile bolts/rolls that are 54" wide. Please contact Customer Experience if goods are a width other than 54".

COM Calculation Example

Below is a hypothetical scenario for how total COM yardage should be determined. This example is for a patterned textile that has a repeat.

STEP 1: DETERMINE WHICH PRODUCTS ARE BEING ORDERED AS COM

For this example order, we'll assume we need to order: 20 units of Freelance 4-leg—backs only.

STEP 2: DETERMINE THE COM YARDAGE REQUIREMENT

Looking at the COM Yardage Requirements chart that begins on page 22, we see that the following yardage amounts are needed for each product:

Freelance 4-leg chair back = 0.94 yards.

Now we multiply 0.94 yards by the 20 chair backs and we get a total of 18.8 yards.

STEP 3: ADJUST THE YARDAGE REQUIREMENT TOTAL BASED ON REPEAT

Since the textile we've chosen is a pattern with a repeat, we should look at the COM Repeat Calculation table to determine our multiplier. For this example, let's assume our repeat is 11" and we're upholstering the fabric vertical/off-the-roll. Based on the table, the multiplier is 20%. Now, we need to take the 18.8 yards from step two and increase it by 20%. An easy way to calculate this is by multiplying 18.8 by 1.2, which gives us 22.6 yards.

STEP 4: ROUND TO GET THE FINAL AMOUNT NEEDED

To determine how much yardage is needed to complete this order, we take the amount from step three and round it to the nearest half-yard. In this case, that means the customer needs to send SitOnIt Seating 23 yards to complete this order.

COM/COL YARDAGE: TASK AND CONFERENCE

Combining upholstery is an option on all SitOnIt Seating upholstered products. Below are tables outlining the fabric or vinyl requirements for the entire chair as well as individual pieces. All yardage requirements are quoted in terms of yards for fabric or vinyl and square feet for leather. Please contact Customer Experience for order quantities greater than 10 seats.

Fabric or Vinyl (In Yardage)

Leather (In Square Feet)

	Fabric or Vinyl (In Yardage)			Leather (In Square Feet)		
	Seat and Back	Seat Only	Back Only	Seat and Back	Seat Only	Back Only
Amplify						
Midback Mesh	—	1	—	—	17	—
Highback Mesh	—	1	—	—	17	—
Highback Mesh Large and Tall	—	1.15	—	—	18	—
Highback Upholstered	1.25	1	0.9	23	17	15
Highback Upholstered Large and Tall	1.25	1.15	—	20	18	—
Midback Mesh Task Stool	—	1	—	—	17	—
Highback Upholstered Task Stool	1.25	1	0.9	23	17	15

Anytime

Light Task and Task Stool	1	0.8	0.75	15	10	8
---------------------------	---	-----	------	----	----	---

Focus

Midback Mesh	—	1	—	—	17	—
Highback Mesh	—	1	—	—	17	—
Midback Upholstered	1.15	1	0.75	23	17	15
Highback Upholstered	1.25	1	0.9	25	17	15
Highback Upholstered Large and Tall	1.25	1.15	—	31	25	—
Midback and Highback Mesh Task Stool	—	1	—	—	17	—
Midback and Highback Upholstered Task Stool	1.15	1	0.75	23	17	15

Focus 2.0

High Back Mesh	—	1	—	—	14	—
----------------	---	---	---	---	----	---

COM/COL YARDAGE: TASK AND CONFERENCE

Fabric or Vinyl (In Yardage)

Leather (In Square Feet)

	Seat and Back	Seat Only	Back Only	Seat and Back	Seat Only	Back Only
Glove						
Active Midback	2.4	1.16	1.18	50	20	25
Active Midback Ballistic Nylon	1.25	1.1	1.15	36	20	20
Active Highback	2.5	1.22	1.28	55	22	32
Active Highback Ballistic Nylon	1.4	1.15	1.2	42	21	22
Executive Midback	3.25	—	—	56	—	—
Executive Midback Ballistic Nylon	2.15	—	—	44	—	—
Executive Highback	3.5	—	—	70	—	—
Executive Highback Ballistic Nylon	2.35	—	—	57	—	—

Hexy

Task and Conference Chair	—	1	—	—	17	—
---------------------------	---	---	---	---	----	---

Inflex

Light Task and Task Stool	1	0.85	0.65	15	10	7
---------------------------	---	------	------	----	----	---

Ioniq

Light Task	—	0.75	—	—	7	—
------------	---	------	---	---	---	---

Knack

Midback	1.85	1	1.1	32	21	23
Midback Ballistic Nylon	1.55	1	1	27	21	15
Midback Task Stool	1.85	1	1.1	32	21	23
Midback Task Stool Ballistic Nylon	1.55	1	1	27	21	15

Lumin

Light Task and Task Stool	1	0.85	0.65	15	10	7
---------------------------	---	------	------	----	----	---

Mavic

Midback Mesh	—	0.8	—	—	14	—
--------------	---	-----	---	---	----	---

Movi

Light Task and Task Stool	—	1.5	—	—	10	—
---------------------------	---	-----	---	---	----	---

COM/COL YARDAGE: TASK AND CONFERENCE

Fabric or Vinyl (In Yardage)

Leather (In Square Feet)

	Seat and Back	Seat Only	Back Only	Seat and Back	Seat Only	Back Only
--	---------------	-----------	-----------	---------------	-----------	-----------

Non-Stop Heavy Duty

Size 1 Stool	1.75	1	1	30	18	20
Size 1 Stool Ballistic Nylon	1.3	1	1	22	18	12
Size 3	2.5	1	1.75	44	17	29
Size 3 Ballistic Nylon	2	1	1.25	35	17	20

Novo

Midback and Highback Mesh	—	1	—	—	17	—
Highback Mesh Large and Tall	—	1.15	—	—	18	—
Midback and Highback Mesh Stool	—	1	—	—	17	—

OnCall

Light Task and Task Stool	0.85	0.8	0.6	14	10	8
---------------------------	------	-----	-----	----	----	---

Orbix

Light Task and Task Stool	—	0.75	—	—	—	—
---------------------------	---	------	---	---	---	---

Prava

Midback	2	0.75	1.5	35	17	28
Highback	2.25	0.75	1.75	40	17	30

ReAlign

Midback	2	1	1.6	34	17	28
Midback Ballistic Nylon	1.7	1	1.25	30	17	21
Highback	2.2	1	1.65	40	17	25
Highback Ballistic Nylon	1.75	1	1.35	32	17	25
Midback Task Stool	2	1	1.6	34	17	28
Midback Task Stool Ballistic Nylon	1.7	1	1.25	30	17	21
Highback Task Stool	2.2	1	1.65	40	17	25
Highback Task Stool Ballistic Nylon	1.75	1	1.35	32	17	25

Relay

Light Task and Task Stool	1	0.75	0.6	15	12	10
---------------------------	---	------	-----	----	----	----

COM/COL YARDAGE: TASK AND CONFERENCE

	Fabric or Vinyl (In Yardage)			Leather (In Square Feet)		
	Seat and Back	Seat Only	Back Only	Seat and Back	Seat Only	Back Only
Rio						
Light Task and Task Stool	1	0.85	0.65	15	10	7
Sona						
Midback Knit	—	1	—	—	17	—
Midback Upholstered	1.75	1	1.25	32	17	21
Torsa						
Highback Mesh	—	1	—	—	17	—
TR2						
Midback	1.5	1	0.9	25	18	18
Midback Ballistic Nylon	1.25	1	0.9	20	18	10
Executive	2	1.25	1.1	36	20	20
Executive Ballistic Nylon	1.7	1.25	1	30	20	15
Midback Task Stool	1.5	1	0.9	25	18	18
Midback Task Stool Ballistic Nylon	1.25	1	0.9	20	18	10
Vectra						
Highback Mesh	—	1.1	—	—	20	—
Wit						
Midback/Highback	N/A	1	N/A	N/A	17	N/A
Midback/Highback Task Stool	N/A	1	N/A	N/A	17	N/A

COM/COL YARDAGE: MULTIPURPOSE AND SIDE

Combining upholstery is an option on all SitOnIt Seating upholstered products. Below are tables outlining the fabric or vinyl requirements for the entire chair as well as individual pieces. All yardage requirements are quoted in terms of yards for fabric or vinyl and square feet for leather. Please contact Customer Experience for order quantities greater than 10 seats.

Fabric or Vinyl (In Yardage)

Leather (In Square Feet)

	Seat and Back	Seat Only	Back Only	Seat and Back	Seat Only	Back Only
--	---------------	-----------	-----------	---------------	-----------	-----------

Achieve

Plastic Back	—	1	—	—	17	—
Upholstered Back	1.75	1	1	30	17	15

Anytime

Multipurpose	1	0.8	0.75	15	10	8
Bar Stool	1	0.8	0.75	15	10	8

Baja

Multipurpose	1	0.75	—	—	—	—
Bar Stool (Standard Back)	1	0.75	—	—	—	—
Bar Stool (Low Back)	0.75	0.75	—	—	—	—

Cora

Guest	1.25 yd	0.9 yd	0.75 yd	21 sq ft	14 sq ft	12 sq ft
Midsized	1.75 yd	1 yd	0.95 yd	27 sq ft	17 sq ft	15 sq ft
Bariatric	2 yd	1.25 yd	1.25 yd	30 sq ft	21 sq ft	18 sq ft

Focus Side

Multipurpose Mesh/Wood	—	1	—	—	17	—
Multipurpose Upholstered	1.25	1	0.75	20	12	10
Counter and Bar Stool Mesh/Wood	—	1	—	—	17	—
Counter and Bar Stool Upholstered	1.25	1	0.75	20	12	10

COM/COL YARDAGE: MULTIPURPOSE AND SIDE

Fabric or Vinyl (In Yardage)

Leather (In Square Feet)

	Seat and Back	Seat Only	Back Only	Seat and Back	Seat Only	Back Only
Freelance						
Multipurpose/Sled	1.25	0.99	1	25	15	—
Multipurpose/Sled Ballistic Nylon	1.15	0.99	0.9	21	15	—
Bariatric (30")	2.25	1	1.35	40	20	—
Bariatric (30") Ballistic Nylon	1.67	1	1	30	20	—
Bariatric (42")	2.5	1.25	1.5	42	25	—
Bariatric (42") Ballistic Nylon	1.75	1.25	1.25	40	25	—
Counter and Bar Stool	1.25	0.99	1	25	15	—
Counter and Bar Stool Ballistic Nylon	1.15	0.9	1	21	15	—

Inflex

Multipurpose	1	0.85	0.65	15	10	7
Counter and Bar Stool	1	0.85	0.65	15	10	7

Ioniq

Multipurpose Chair	—	0.75	—	—	7	—
Guest Chair	—	0.75	—	—	7	—

Lumin

Multipurpose	1	0.85	0.65	15	10	7
Wire Rod	1	0.85	0.65	15	10	7
Counter and Bar Stool	1	0.85	0.65	15	10	7

Mika

4-Leg	—	0.85	—	—	—	—
Wire Rod	—	0.85	—	—	—	—
Counter and Bar Stool	—	0.85	—	—	—	—

Movi

Nester	—	0.75	—	—	10	—
--------	---	------	---	---	----	---

OnCall

Multipurpose	0.85	0.8	0.6	14	10	8
Bar Stool	0.85	0.8	0.6	14	10	8

COM/COL YARDAGE: MULTIPURPOSE AND SIDE

Fabric or Vinyl (In Yardage)

Leather (In Square Feet)

	Seat and Back	Seat Only	Back Only	Seat and Back	Seat Only	Back Only
--	---------------	-----------	-----------	---------------	-----------	-----------

Orbix

Multipurpose	—	0.75	—	—	—	—
Bar Stool	—	0.75	—	—	—	—

Qwiz

Nester	1	0.75	—	—	—	—
--------	---	------	---	---	---	---

Relay

Multipurpose	1	0.75	0.6	15	12	10
Nester	1	0.75	0.6	15	12	10

Rio

Multipurpose	1	0.85	0.65	15	10	7
Wire Rod	1	0.85	0.65	15	10	7
Counter and Bar Stool	1	0.85	0.65	15	10	7

Rowdy

Wire Rod	—	0.75	—	—	13	—
----------	---	------	---	---	----	---

Wit Side

Multipurpose	—	0.75	—	—	10	—
--------------	---	------	---	---	----	---

COM/COL YARDAGE: LOUNGE

Combining upholstery is an option on all SitOnIt Seating upholstered products. Below are tables outlining the fabric or vinyl requirements for the entire chair as well as individual pieces. All yardage requirements are quoted in terms of yards for fabric or vinyl and feet for leather. Please contact Customer Experience for order quantities greater than 10 seats.

	Fabric or Vinyl (In Yardage)			Leather (In Square Feet)		
	Fully Upholstered	Seat Only	Back Only	Fully Upholstered	Seat Only	Back Only
Aviera						
Guest 21"	1.9	1.2	1.1	29.4	—	—
Guest 24"	1.9	1.2	1.6	43.4	—	—
Guest 30"	3.1	1.2	1.9	47.6	—	—
Guest 44"	3.4	1.6	1.9	50.4	—	—
Hip Chair	1.9	1.2	1.1	29.4	—	—
Patient 21"	2.8	1.2	1.9	35	—	—
Patient 24"	2.8	1.2	2.2	43.4	—	—
Patient 30"	3.8	1.2	2.5	50	—	—
Freespan 2-Seat 21"	3.8	1.9	2.1	58	—	—
Freespan 2-Seat 24"	4.3	2.2	3.1	86	—	—
Freespan 3-Seat 21"	5.6	3	3.1	88.2	—	—
Freespan 3-Seat 24"	5.9	3	4.7	93	—	—
Pre-Configured 2-Seat 21"	3.8	1.9	2.1	58	—	—
Pre-Configured 2-Seat 24"	4.3	2.2	3.1	86	—	—
Pre-Configured 3-Seat 21"	5.6	3	3.1	88.2	—	—
Pre-Configured 3-Seat 24"	5.9	3	4.7	93	—	—
Start/Center/End 21"	2.8	1.2	1.9	35	—	—
Start/Center/End 24"	2.8	1.2	2.2	43.4	—	—
Start/Center/End 30"	3.8	1.2	2.5	47.6	—	—
Start/Center/End 44"	3.4	1.6	1.9	50.4	—	—

COM/COL YARDAGE: LOUNGE

Fabric or Vinyl (In Yardage)

Leather (In Square Feet)

	Fully Upholstered	Seat Only	Back Only	Fully Upholstered	Seat Only	Back Only
Comeo						
Single Seat, Dual Arms	5	1.75	1.6	2.25	—	99
Single Seat, Right or Left Arm	4	1.75	1.6	1.25	—	78
Single Seat, Armless	3.25	1.75	1.6	—	—	63
Single Seat, Bench	2	2	—	—	—	36
2-Seater, Dual Arms	7.5	3.25	3	2.25	—	147
2-Seater, Right or Left Arm	6.5	3.25	3	1.25	—	126
2-Seater, Armless	5.75	3.25	3	—	—	115
2-Seater, Bench	3.75	3.75	—	—	—	68
3-Seater, Dual Arms	10.5	5	4.75	2.25	—	170
3-Seater, Right or Left Arm	9	5	4.75	1.25	—	150
3-Seater, Armless	8	5	4.75	—	—	130
3-Seater, Bench	5	5	—	—	—	84

Composium

Club Chair	5.3	1.9	2.2	3.8	1	83.3
Settee	7.9	3.2	4.1	3.8	1.3	122.5
Sofa	10.5	3.8	5.8	3.8	1.3	163.7
Ottoman	3.2	1.9	—	—	1.9	49
Bench, Single Seat	3.2	1.9	—	—	1.9	49
Bench, Double Seat	3.8	2.9	—	—	2.9	58.8
Bench, Triple Seat	4.4	2.9	—	—	2.9	68.6

Envoi

Midback Club Chair	3	1	2.5	—	—	50
Highback Club Chair	3.25	1	2.75	—	—	55

Envoi back yardage includes yardage for arms.

Gobi

Club Chair	3.5	2.8	1	—	—	55
------------	-----	-----	---	---	---	----

Gobi back yardage includes yardage for arms.

COM/COL YARDAGE: LOUNGE

Fabric or Vinyl (In Yardage)

Leather (In Square Feet)

	Fully Upholstered	Seat Only	Back Only	Fully Upholstered	Seat Only	Back Only
Nano						
Triangle	2	1	—	—	2	—
Diamond	3	1.5	—	—	2	—
Trapezoid	3.5	1.5	—	—	3	—
Boomerang	6.5	3	—	—	4	—

Paséa

Seat, Single	3	2	1.56	—		
Seat, 1½	4	2.5	1.75	—		
Seat, 90-Degree	5.25	2.75	3	—		
Seat, 120-Degree Inner or Outer	4.38	2.75	2.5	—		
Bench, Single	2	2	—	—		
Bench, 1½	2.5	2.5	—	—		
Bench, Right-Angled or Left-Angled	2.5	2.5	—	—		
Bench, 90° Corner	2.5	2.5	—	—		
Bench, 120° Bench	2.5	2.5	—	—		
Ottoman, Mini Round	1.75	1	—	—		
Ottoman, Mini Square	1.88	1	—	—		
Ottoman, Mini With Table Top	1.25	—	—	—		
Ottoman, Large Round	3.35	1.56	—	—		
Ottoman, Large Square	3.44	1.56	—	—		
Ottoman, Large With Table Top	2	—	—	—		

Visit Modular

Ottoman	1.88	1.88	—	—	0.94	29.4
Club Chair, Armless	3.5	1.9	2.2	—	—	54.5
Club Chair, Upholstered Left or Right Arm	4.4	1.9	2.2	1.88	—	83.3
Club Chair, Upholstered Left and Right Arms	5.4	1.9	2.2	2.9	—	83.3
Club Chair, Wood Left or Right Arm	3.5	1.9	2.2	—	—	54.5
Club Chair, Wood Left and Right Arms	3.5	1.9	2.2	—	—	54.5

CUSTOM FINISH PROGRAM

Pricing

First-time custom stains must be approved before acceptance of an order. A one-time net fee applies if stains are not in our library. Thereafter, a stain-to-match upcharge is applied to each chair.

LOUNGE

Stain not in our library: \$275 Net
Stain-to-match upcharge: \$70 List

Ordering

When ordering, enter the approved STAIN ID# in the Material section of the Final Price Calculation worksheet or on your purchase order.

Custom Finish Terms and Conditions

Wood is inherently beautiful because of natural variations in color, grain and texture. There may be minor differences from one chair to the next, even though they are finished at the same time. We cannot guarantee exact matches of grain or natural wood color.

Approval Process

Since all new stains must be approved before they can be applied to seating or tables, allow extra time for custom finishes. Custom finishes generally require at least one to two weeks to create a matched sample. We will need a signed Approval Form before we can accept your order. We reserve the right to decline the opportunity to match a finish color.

1. Send a 3" x 4" or 4" x 6" sample of the stain, along with the model numbers and options to which the finish will be applied, to:

Customer Experience
Custom Finish Program
6415 Katella Avenue
Cypress, CA 90630

Include dealer name, contact and project reference.

2. Once approved, we will send a finish sample to you along with any caveats that may apply. We will keep an identical sample in our files for future orders. Custom finishes generally require at least a week to create a matched sample.
3. Carefully review the sample. Note the STAIN ID# (example: SM#070214-1); this will be needed for your order. Return the signed approval form to Customer Experience along with your order. We need your approval before we can accept the order, schedule it for production or acknowledge a ship date.
4. Lounge orders using our stain-to-match program will have a lead time of 15 days.

Chairs and Stools

TASK | LIGHT TASK | EXECUTIVE
CONFERENCE | COLLABORATIVE

Statement of Line

TASK | LIGHT TASK | EXECUTIVE CONFERENCE | COLLABORATIVE



Amplify Mesh
Midback Task Chair
2722 B1 [Page 38](#)



Amplify Mesh
Highback Task Chair
2723 B1 [Page 38](#)



Amplify Mesh
Midback Task Stool
2722 B3 S1/S2 [Page 42](#)

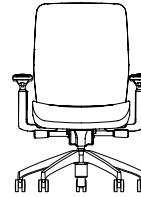

Amplify Upholstered
Highback Task Chair
2722 B1 [Page 46](#)

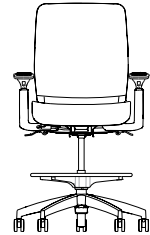

Amplify Upholstered
Highback Task Stool
2723 B3 S1/S2 [Page 50](#)



Anytime
Light Task Chair
93T [Page 53](#)



Anytime
Light Task Stool
93T S1 [Page 53](#)

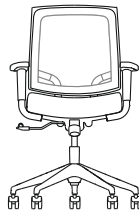

Focus Mesh
Midback Task Chair
5622 B1 [Page 56](#)

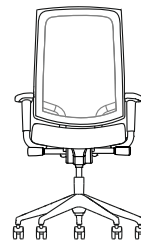

Focus Mesh
Highback Task Chair
5623 B1 [Page 56](#)

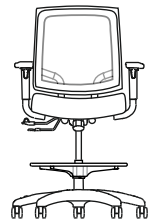

Focus Mesh
Highback Stool
5622 B1 S1/S2 [Page 61](#)

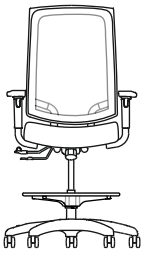

Focus Mesh
Highback Stool
5623 B1 S1/S2 [Page 61](#)

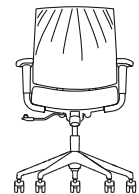

Focus Upholstered
Midback Task Chair
5622 B4 [Page 65](#)

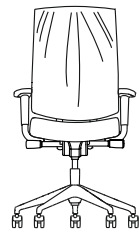

Focus Upholstered
Highback Task Chair
5623 B4 [Page 65](#)

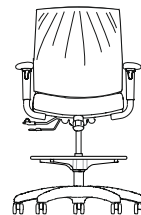

Focus Upholstered
Midback Task Stool
5622 B4 S1/S2 [Page 70](#)

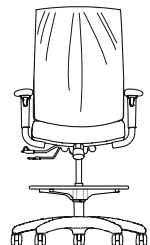

Focus Upholstered
Highback Task Stool
5623 B4 S1/S2 [Page 70](#)



Focus 2.0
Midback Mesh Task Chair
1123 BK1 MB [Page 74](#)

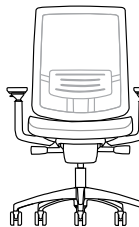

Focus 2.0
Highback Mesh Task Chair
1123 BK2 MB [Page 74](#)



Focus 2.0
Midback Mesh Task Stool
1123 BK1 MB S1/S2 [Page 79](#)

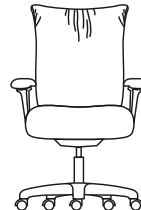

Glove Active
Midback Conference Chair
7531 [Page 83](#)

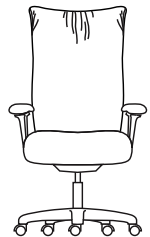

Glove Active
Highback Conference Chair
7532 [Page 83](#)

Statement of Line

TASK | LIGHT TASK | EXECUTIVE CONFERENCE | COLLABORATIVE

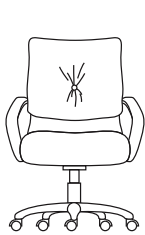

Glove Executive
Midback Conference Chair
7541 [Page 87](#)

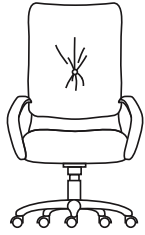

Glove Executive
Highback Executive Chair
7542 [Page 87](#)

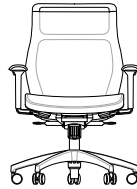

Hexy
Midback Mesh Task Chair
1203 BK1 MB [Page 90](#)



Hexy
Highback Mesh Task Chair
1203 BK2 MB [Page 90](#)



Hexy
Midback Mesh Task Stool
1203 BK1 MB S1/S2. [Page 94](#)



InFlex
Light Task Chair
973 [Page 98](#)



InFlex
Light Task Stool
973B S1/S2 [Page 98](#)

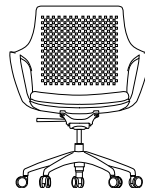

Ioniq
Collaborative Chair
1152 FT3..... [Page 101](#)



Knack
Midback Task Chair
3323 [Page 104](#)



Knack
Midback Task Stool
3323 S1/S2..... [Page 108](#)

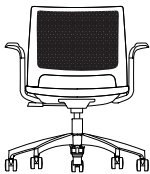

Lumin
Light Task Chair
1012 FT3..... [Page 111](#)



Lumin
Light Task Stool
1012 FT3 S21/S22.. [Page 111](#)



Mavic
Collaborative Chair
1113 [Page 115](#)



Movi
Light Task Chair
1062 FT3..... [Page 118](#)



Movi
Light Task Stool
1062 FT3 S21/S22.. [Page 118](#)



Non-Stop Heavy Duty XL
Heavy Duty Task Chair
673 [Page 121](#)



Non-Stop Heavy Duty XL
Heavy Duty Task Stool
671 B2..... [Page 124](#)



Novo
Midback Mesh Task Chair
1033 BK1..... [Page 127](#)

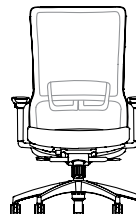

Novo
Highback Mesh Task Chair
1033 BK2..... [Page 127](#)

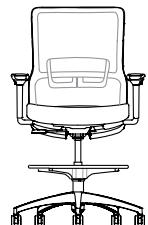

Novo
Midback Mesh Task Stool
1033 BK1 S1..... [Page 132](#)

Statement of Line

TASK | LIGHT TASK | EXECUTIVE CONFERENCE | COLLABORATIVE

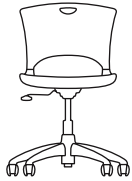

OnCall

Light Task Chair
90T [Page 136](#)



OnCall

Light Task Stool
90TB S1/S2 [Page 136](#)



Orbix

Light Task Chair
1132 FT3 CH1..... [Page 140](#)



Orbix

Light Task Stool
1132 FT3 S21/S22.. [Page 140](#)

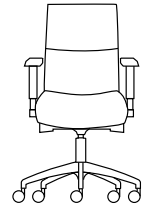

Prava

Midback Conference Chair
6422 [Page 143](#)

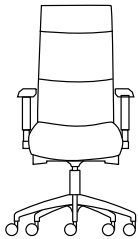

Prava

Highback Conference Chair
6423 [Page 143](#)



ReAlign

Midback Task Chair
681 [Page 147](#)

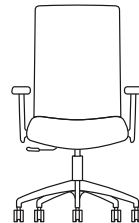

ReAlign

Highback Task Chair
682 [Page 147](#)



ReAlign

Midback Task Stool
681B [Page 152](#)

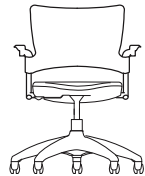

Relay

Light Task Chair
94T [Page 156](#)



Relay

Light Task Stool
94B S1/S2 [Page 156](#)

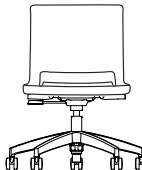

Rio

Light Task Chair
1052 FT3..... [Page 160](#)

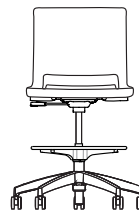

Rio

Light Task Chair
1052 FT3 S21/S22.. [Page 160](#)

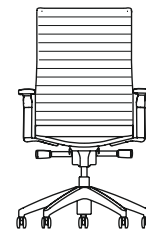

Sona

Knit Back Conference Chair
5723 B7 [Page 164](#)

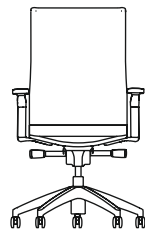

Sona

Upholstered Conference Chair
5723 B8 [Page 164](#)

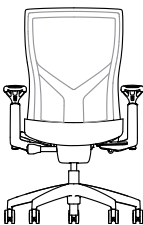

Torsa

Mesh Back Conference Chair
5723 B8 [Page 168](#)



TR2

Midback Task Chair
40 [Page 172](#)



TR2

Highback Executive Chair
40E [Page 172](#)



TR2

Midback Task Stool
40 S1/S2..... [Page 176](#)

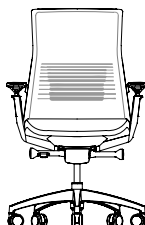

Vectra

Highback Mesh Task Chair
1073 BK2 MB [Page 180](#)

Statement of Line

TASK | LIGHT TASK | EXECUTIVE CONFERENCE | COLLABORATIVE

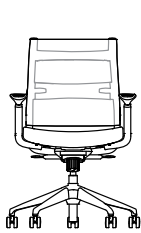

Wit Mesh

Midback Task Chair
2222 B1 [Page 184](#)

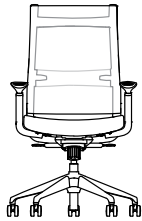

Wit Mesh

Highback Task Chair
2223 B1 [Page 184](#)



Wit Mesh

Midback Task Stool
2222 B1 S1/S2 [Page 188](#)

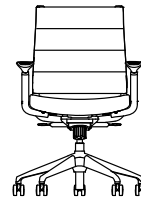

Wit Thintex

Midback Task Chair
2222 B9 [Page 192](#)

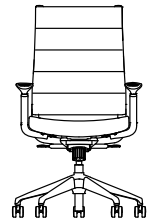

Wit Thintex

Highback Task Chair
2223 B9 [Page 192](#)

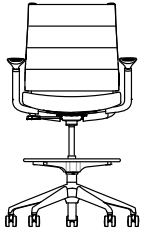

Wit Thintex

Midback Task Stool
2222 B9 S1/S2 [Page 196](#)

Amplify

MESH BACK TASK CHAIR

The power of more.

The sleek, aerodynamic design gives Amplify™ power with the appearance of smart, no-nonsense efficiency and comfort. The supportive mesh back with adjustable lumbar support, three application-specific arm types and waterfall seat add great ergonomics and comfort to the equation. The eye-catching lumbar bands, curvaceous profile and soft, textured arm pads make this a chair that delivers style as well as substance.



EFFECTIVE OCTOBER 17, 2022

Featured Models

GOOD :: \$747

Midback, black frame, swivel-tilt mechanism, fixed arms, black nylon base, carpet casters, grade 1 textile

BETTER :: \$835

Highback, black frame, enhanced synchro mechanism, height-adjustable arms, black nylon base, carpet casters, grade 1 textile



BEST :: \$979

Highback, fog frame, enhanced synchro mechanism with seat-depth adjustment, multi-adjustable arms, fog nylon base, carpet casters, grade 1 textile

Features

- Midback or highback task chair
- Aerodynamic design
- Multiple frame, back support and arm color choices
- Adjustable lumbar support
- 10 bleach-cleanable mesh back colors
- Contrast stitching in 10 thread colors
- Enhanced synchro or swivel-tilt
- Waterfall seat
- Three arm styles with textured arm pads
- Black, fog or polished aluminum base
- Optional seat-depth adjustment
- Standard 300 lb weight capacity warranty;
Heavy Duty Series 400 lb weight capacity warranty

1. Back

Back Size and Style	Code	Price	
Midback Mesh With Adjustable Lumbar Support	2722 B1	\$807	
Highback Mesh With Adjustable Lumbar Support	2723 B1	\$835	

2. Heavy Duty

Heavy Duty Series	Code	Price	
Large and Tall (Black Highback Frame With Enhanced Synchro Y Mechanism and Sport Height-Adjustable Arms)	LT	+ \$250	

See the Super Duty Guide on [page 591](#) for additional LT and HD options.

MESH BACK TASK CHAIR

3. Mechanism

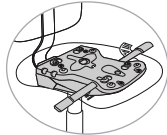
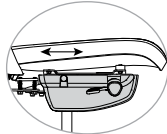
Mechanism Style	Code	Price	
Swivel-Tilt	T	- \$50	
Enhanced Synchro	Y	+ \$0	
Enhanced Synchro With Seat-Depth Adjustment	Y E3	+ \$79	

Seat-depth adjustment (E3) available with enhanced synchro (Y) mechanism only.





4. Frame

Frame Color	Code	Price	
Black	FC1	+ \$0	
Fog	FC13	+ \$35	

Frame color includes base, lumbar support band and arms.

5. Arms

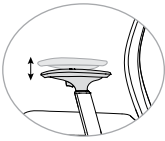
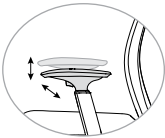
Arm Style	Code	Price	
Armless	A0	- \$48	
Fixed Polyurethane	A140	- \$10	
Height-Adjustable	A141	+ \$0	
Multi-Adjustable (Height/Width)	A142	+ \$30	



Arm color will match the frame. Arm pads are black except fixed polyurethane arm (A140) which matches frame color.

6. Base

Base Color and Material	Code	Price	
Black Nylon Base (For Black Frame FC1)	B17	+ \$0	
Fog Nylon Base (For Fog Frame FC13)	B21	+ \$0	
Polished Aluminum Base	B18	+ \$113	

MESH BACK TASK CHAIR

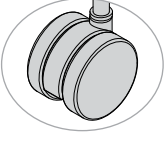
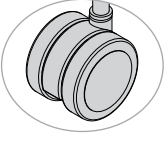
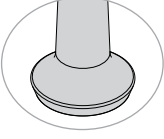
6. Base (Cont.)

Casters or Glides	Code	Price	
Casters			
Black Carpet Casters	C16	+ \$0	
Black Hard Floor and Carpet Casters	C17	+ \$40	
Glides			
Glides for Task Chairs	C3	+ \$30	
Cylinder Height	Code	Price	
Standard Cylinder	S0	+ \$0	
Higher Cylinder	S13	+ \$0	

Nylon bases pair only with their corresponding frame color. Polished aluminum base (B18) can be used with all frame colors.

7. Material

Protection	Code	Price	
Fire Retardency			
CAL 133, Fabric, Quantities 1-49	133F	+ \$99	
CAL 133, Fabric, Quantities 50+	133F5	+ \$55	
CAL 133, Leather, Any Quantity	133L	+ \$119	
Mesh Color	Code	Price	
Apple	MC31	+ \$0	
Aqua	MC30	+ \$0	
Desert	MC9	+ \$0	
Electric Blue	MC24	+ \$0	
Fire	MC10	+ \$0	
Fog	MC7	+ \$0	
Navy	MC8	+ \$0	
Nickel	MC6	+ \$0	
Onyx	MC5	+ \$0	
Tangerine	MC28	+ \$0	

7. Material (Cont.)

Seat Textile	Code	Price	
Fabric/Vinyl Grade 1	FG1/VG1	+ \$0	
COM	COM	+ \$26	
Fabric/Vinyl Grade 2	FG2/VG2	+ \$26	
Fabric/Vinyl Grade 3	FG3/VG3	+ \$60	
Fabric/Vinyl Grade 4	FG4/VG4	+ \$116	
Fabric/Vinyl Grade 5	FG5/VG5	+ \$172	
Fabric/Vinyl Grade 6	FG6/VG6	+ \$213	
Fabric/Vinyl Grade 7	FG7/VG7	+ \$254	
Leather Grade 1	LG1	+ \$300	
COL	COL	+ \$380	
Leather Grade 2	LG2	+ \$380	
Leather Grade 3	LG3	+ \$480	
Contrast Stitching	Code	Price	
No Contrast Stitching	TC0	+ \$0	
Apple Thread	TC3	+ \$0	
Desert Thread	TC9	+ \$0	
Electric Blue Thread	TC4	+ \$0	
Fire Thread	TC10	+ \$0	
Fog Thread	TC7	+ \$0	
Lemon Thread	TC2	+ \$0	
Navy Thread	TC8	+ \$0	
Nickel Thread	TC6	+ \$0	
Onyx Thread	TC5	+ \$0	
White Thread	TC1	+ \$0	

Contrast stitching available only for SitOnIt Seating carded fabrics in solid colors.

Please reference the [Textile Reference Guide](#) for pricing on fabric over grade 7 and leather over grade 3. Additional CAL 133 information can be found on [page 15](#).

8. Packaging

Packaging	Code	Price	
Knocked Down	KD	+ \$0	
Back Attached to Seat, Base Separate	UC	+ \$80	
Fully Assembled in a Carton	AC	+ \$200	

MESH BACK TASK CHAIR

SPECIFICATIONS

	2722 B1 Midback Mesh Task Chair	2723 B1 Highback Mesh Task Chair	2723 B1 LT Large and Tall Task Chair
Dimensions			
Overall Width Without Arms	26"	26"	26"
Overall Width With Arms	27.75"-28.25"	27.75"-28.25"	29"
Overall Depth	24.5"	24.5"	29"
Overall Height	40"	43"	42"
Seat Width	19.25"	19.25"	22"
Seat Depth	17.5"-19.75"	17.5"-19.5"	17.5"-19.75"
Seat Height With Standard Base	16.5"-20.12" (T) 16.5"-20.35" (Y)	16.5"-20.12" (T) 16.5"-20.35" (Y)	N/A 16.75"-19.75" (Y)
Seat Height With Higher Cylinder	17.5"-21.87" (T) 18"-22.5" (Y)	18"-23" (T) 18"-22.5" (Y)	N/A 20.5"-25" (Y)
Back Width	19.5"	19.5"	19.5"
Back Height	20.37"	23.37"	22"
Materials			
COM	1 yd	1 yd	1.15 yd
COL	17 sq ft	17 sq ft	18 sq ft
Weight and Capacity			
Weight Armless	32 lb	34 lb	44 lb
Weight With Arms	37 lb	39 lb	50 lb
Weight Capacity Warranty	300 lb	300 lb	400 lb

Swivel-tilt mechanism (T). Enhanced synchro mechanism (Y).

Amplify

MESH BACK TASK STOOL

The power of more.

The sleek, aerodynamic design gives Amplify™ power with the appearance of smart, no-nonsense efficiency and comfort. The supportive mesh back with adjustable lumbar support, three application-specific arm types and waterfall seat add great ergonomics and comfort to the equation.

The eye-catching lumbar bands, curvaceous profile and soft, textured arm pads make this a stool that delivers style as well as substance.



EFFECTIVE OCTOBER 17, 2022

Featured Models

GOOD :: \$836

Midback mesh, basic mechanism, black frame, armless, black nylon base, carpet casters, grade 1 textile

BETTER :: \$884

Midback mesh, basic mechanism, black frame, height-adjustable arms, black nylon base, carpet casters, grade 1 textile

BEST :: \$973

Midback mesh, basic mechanism, fog frame, multi-adjustable arms, extended stool kit, fog nylon base, carpet casters, grade 1 textile

Features

- Midback task stool
- Aerodynamic design
- Multiple frame, back support and arm color choices
- Adjustable lumbar support
- 10 bleach-cleanable mesh back colors
- Contrast stitching in 10 thread colors
- Waterfall seat
- Three arm styles with textured arm pads
- Black, fog or polished aluminum base
- Standard 300 lb weight capacity warranty

1. Back

Back Size and Style	Code	Price	
Midback Mesh Task Stool With Adjustable Lumbar Support	2722 B1	\$884	

2. Mechanism

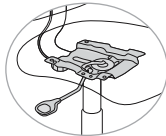
Mechanism Style	Code	Price	
Basic (Swivel Only)	B	+ \$0	



3. Frame

Frame Color	Code	Price	
Black	FC1	+ \$0	
Fog	FC13	+ \$35	

Frame color includes base, lumbar support band and arms.

MESH BACK TASK STOOL

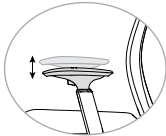
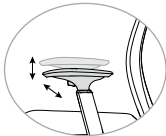

4. Arms

Arm Style	Code	Price	
Armless	A0	- \$48	
Fixed Polyurethane	A140	- \$10	
Height-Adjustable	A141	+ \$0	
Multi-Adjustable (Height/Width)	A142	+ \$30	

Arm color will match the frame. Arm pads are black except fixed polyurethane arm which matches frame color.

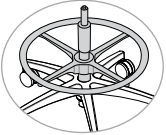
5. Base

Base	Code	Price	
Stool Kit	S1	+ \$0	
Extended Stool Kit	S2	+ \$24	

Base Color and Material	Code	Price	
Black Nylon Base (For Black Frame – FC1)	B17	+ \$0	
Fog Nylon Base (For Fog Frame – FC13)	B21	+ \$0	
Polished Aluminum Base	B18	+ \$113	

Nylon bases pair only with their corresponding frame color. Polished aluminum base (B18) can be used with all frame colors.

5. Base (Cont.)

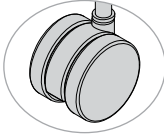
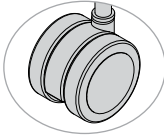
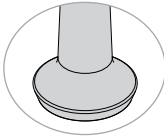
Casters or Glides	Code	Price	
Casters			
Black Carpet Casters	C16	+ \$0	
Black Hard Floor and Carpet Casters	C17	+ \$40	
Glides			
Glides for Task Chairs	C3	+ \$30	

6. Material

Protection	Code	Price	
Fire Retardancy			
CAL 133, Fabric, Quantities 1-49	133F	+ \$99	
CAL 133, Fabric, Quantities 50+	133F5	+ \$55	
CAL 133, Leather, Any Quantity	133L	+ \$119	
Mesh Color	Code	Price	
Apple	MC31	+ \$0	
Aqua	MC30	+ \$0	
Desert	MC9	+ \$0	
Electric Blue	MC24	+ \$0	
Fire	MC10	+ \$0	
Fog	MC7	+ \$0	
Navy	MC8	+ \$0	
Nickel	MC6	+ \$0	
Onyx	MC5	+ \$0	
Tangerine	MC28	+ \$0	

MESH BACK TASK STOOL

6. Material (Cont.)

Seat Textile	Code	Price	
Fabric/Vinyl Grade 1	FG1/VG1	+ \$0	
COM	COM	+ \$26	
Fabric/Vinyl Grade 2	FG2/VG2	+ \$26	
Fabric/Vinyl Grade 3	FG3/VG3	+ \$60	
Fabric/Vinyl Grade 4	FG4/VG4	+ \$116	
Fabric/Vinyl Grade 5	FG5/VG5	+ \$172	
Fabric/Vinyl Grade 6	FG6/VG6	+ \$213	
Fabric/Vinyl Grade 7	FG7/VG7	+ \$254	
Leather Grade 1	LG1	+ \$300	
COL	COL	+ \$380	
Leather Grade 2	LG2	+ \$380	
Leather Grade 3	LG3	+ \$480	
Contrast Stitching	Code	Price	
No Contrast Stitching	TC0	+ \$0	
Apple Thread	TC3	+ \$0	
Desert Thread	TC9	+ \$0	
Electric Blue Thread	TC4	+ \$0	
Fire Thread	TC10	+ \$0	
Fog Thread	TC7	+ \$0	
Lemon Thread	TC2	+ \$0	
Navy Thread	TC8	+ \$0	
Nickel Thread	TC6	+ \$0	
Onyx Thread	TC5	+ \$0	
White Thread	TC1	+ \$0	

Contrast stitching available only for SitOnIt Seating carded fabrics in solid colors.

Please reference the [Textile Reference Guide](#) for pricing on fabric over grade 7 and leather over grade 3. Additional CAL 133 information can be found on [page 15](#).

7. Packaging

Packaging	Code	Price	
Knocked Down	KD	+ \$0	
Back Attached to Seat, Base Separate	UC	+ \$80	
Fully Assembled in a Carton	AC	+ \$200	

EFFECTIVE OCTOBER 17, 2022 | GSA SIN #: 33721

SPECIFICATIONS

	2722 B1 S1 Task Stool	2722 B1 S2 Extended Task Stool
Dimensions		
Overall Width Armless	24.5"	24.5"
Overall Width With Arms	27.75"-28.25"	27.75"-28.25"
Overall Depth	24.5"	24.5"
Overall Height	39"-46.5"	43.75"-53.38"
Seat Width	19.25"	19.25"
Seat Depth	17.75"	17.75"
Seat Height	21.5"-29.5"	25"-35"
Back Width	19.5"	19.5"
Back Height	20.37"	20.37"
Materials		
COM	1 yd	1 yd
COL	17 sq ft	17 sq ft
Weight and Capacity		
Weight Armless	34 lb	35 lb
Weight With Arms	39.5 lb	40 lb
Weight Capacity	300 lb	300 lb



Good

Amplify

UPHOLSTERED BACK TASK CHAIR

The power of more.

In keeping with the aerodynamic design of the well-regarded Amplify™ mesh model, the Amplify upholstered chair's sleek and slender profile proves that this is a chair that delivers style as well as substance.



EFFECTIVE OCTOBER 17, 2022

Featured Models

GOOD :: \$862

Highback upholstered, black frame, swivel-tilt mechanism, fixed arms, black nylon base, carpet casters, grade 1 textile

BETTER :: \$922

Highback upholstered, black frame, enhanced synchro mechanism, height-adjustable arms, black nylon base, carpet casters, grade 1 textile

BEST :: \$1,066

Highback upholstered, fog frame, enhanced synchro mechanism with seat-depth adjustment, multi-adjustable arms, fog nylon base, carpet casters, grade 1 textile

Features

- Highback task chair
- Aerodynamic design
- Multiple frame, back support and arm color choices
- Adjustable lumbar support
- Enhanced synchro or swivel-tilt
- Waterfall seat
- Three arm styles with textured arm pads
- Black, fog, silver or polished aluminum base
- Optional seat-depth adjustment
- Standard 300 lb weight capacity warranty;
Heavy Duty Series 400 lb weight capacity warranty

1. Back

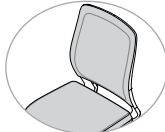
Back Size and Style	Code	Price	
Highback Upholstered With Dynamic Lumbar	2723 B3	\$922	

2. Mechanism

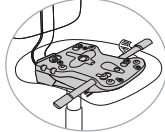
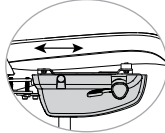
Mechanism Style	Code	Price	
Swivel-Tilt	T	- \$50	
Enhanced Synchro	Y	+ \$0	
Enhanced Synchro With Seat-Depth Adjustment	Y E3	+ \$79	

Seat-depth adjustment (E3) is not available on swivel-tilt (T) mechanism.

UPHOLSTERED BACK TASK STOOL

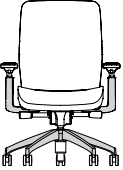

3. Frame

Frame Color	Code	Price	
Black, Single-Color Nylon Frame	FC1	+ \$0	
Fog, Single-Color Nylon Frame	FC13	+ \$35	
Fog With Silver, Two-Color Nylon Frame	FC14	+ \$35	

Single-color nylon frame includes base, back support and arms.

Two-color nylon frame includes fog frame with silver back support and silver base. Adjustable arms are silver. Fixed arms are fog.

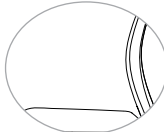
4. Arms

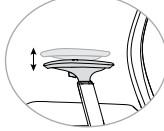
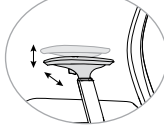
Arm Style	Code	Price	
Armless	A0	- \$48	
Fixed Polyurethane	A140	- \$10	
Height-Adjustable	A141	+ \$0	
Multi-Adjustable (Height/Width)	A142	+ \$30	

Arm color will match the frame. Arm pads are black except fixed polyurethane arm which matches frame color.

5. Base

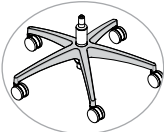
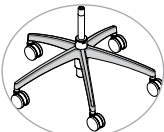
Base Color and Material	Code	Price	
Black Nylon Base (For Black Frame FC1)	B17	+ \$0	
Fog Nylon Base (For Fog Frame FC13)	B21	+ \$0	
Silver Nylon Base (For Fog Frame With Silver FC14)	B22	+ \$0	
Polished Aluminum Base	B18	+ \$113	

Nylon bases pair only with their corresponding frame color. Polished aluminum base (B18) can be used with all frame colors.

6. Base (Cont.)

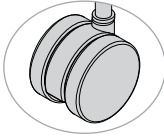
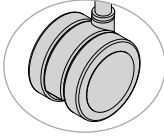
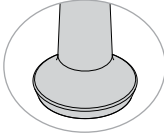
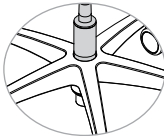
Casters or Glides	Code	Price	
Casters			
Black Carpet Casters	C16	+ \$0	
Black Hard Floor and Carpet Casters	C17	+ \$40	
Glides			
Glides for Task Chairs	C3	+ \$30	
Cylinder Height	Code	Price	
Standard Cylinder	S0	+ \$0	
Higher Cylinder	S13	+ \$0	

7. Material

Protection	Code	Price	
Fire Retardancy			
CAL 133, Fabric, Quantities 1-49	133F	+ \$99	
CAL 133, Fabric, Quantities 50+	133F5	+ \$55	
CAL 133, Leather, Any Quantity	133L	+ \$119	

UPHOLSTERED BACK TASK STOOL

7. Material (Cont.)

Seat and Back Textile	Code	Price	
Fabric/Vinyl Grade 1	FG1/VG1	+ \$0	
COM	COM	+ \$34	
Fabric/Vinyl Grade 2	FG2/VG2	+ \$34	
Fabric/Vinyl Grade 3	FG3/VG3	+ \$74	
Fabric/Vinyl Grade 4	FG4/VG4	+ \$121	
Fabric/Vinyl Grade 5	FG5/VG5	+ \$174	
Fabric/Vinyl Grade 6	FG6/VG6	+ \$235	
Fabric/Vinyl Grade 7	FG7/VG7	+ \$296	
Leather Grade 1	LG1	+ \$320	
COL	COL	+ \$420	
Leather Grade 2	LG2	+ \$420	
Leather Grade 3	LG3	+ \$540	

Please reference the [Textile Reference Guide](#) for pricing on fabric over grade 7 and leather over grade 3. Additional CAL 133 information can be found on [page 15](#).

Please reference the [Fabric information](#) found on [page 17](#) for pricing on multi-upholstery.

8. Packaging

Packaging	Code	Price	
Knocked Down	KD	+ \$0	
Back Attached to Seat, Base Separate	UC	+ \$80	
Fully Assembled in a Carton	AC	+ \$200	

UPHOLSTERED BACK TASK CHAIR

SPECIFICATIONS

2723 B3 Highback Upholstered Task Chair	
Dimensions	
Overall Width Armless	26"W
Overall Width With Arms	27.75"
Overall Depth	24.5"
Overall Height	42"
Seat Width	19.25"
Seat Depth	17.5"-19.5"
Seat Height With Standard Cylinder (S0)	16.5"-20.12" (T) 16.5"-20.35" (Y)
Seat Height With Higher Cylinder (S13)	17.5"-21.87" (T) 18"-22.5" (Y)
Back Width	19.5"
Back Height	23.37"
Materials	
COM	1.25 yd
COL	23 sq ft
Weight and Capacity	
Weight Armless	35 lb
Weight With Arms	40 lb
Weight Capacity	300 lb

Swivel tilt mechanism (T). Enhanced synchro mechanism (Y).



Better

Amplify

UPHOLSTERED BACK TASK STOOL

The power of more.

In keeping with the aerodynamic design of the well-regarded Amplify™ mesh model, the Amplify upholstered chair's sleek and slender profile proves that this is a stool that delivers style as well as substance.



Featured Models

GOOD :: \$923

Highback upholstered, basic mechanism, black frame, armless, black nylon base, carpet casters, grade 1 textile

BETTER :: \$971

Highback upholstered, basic mechanism, black frame, height-adjustable arms, black nylon base, carpet casters, grade 1 textile

BEST :: \$1,060

Highback upholstered, basic mechanism, fog frame, multi-adjustable arms, extended stool kit, fog nylon base, carpet casters, grade 1 textile

Features

- Highback task stool
- Aerodynamic design
- Multiple frame, back support and arm color choices
- Adjustable lumbar support
- Waterfall seat
- Three arm styles with textured arm pads
- Black, fog or polished aluminum base
- Standard 300 lb weight capacity warranty

1. Back

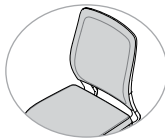
Back Size and Style	Code	Price	
Highback Upholstered Task Stool With Dynamic Lumbar	2723 B3	\$971	

2. Mechanism

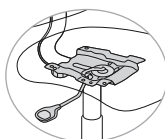
Mechanism Style	Code	Price	
Basic (Swivel Only)	B	+ \$0	

3. Frame

Frame Color	Code	Price	
Black, Single-Color Nylon Frame	FC1	+ \$0	
Fog, Single-Color Nylon Frame	FC13	+ \$35	
Fog With Silver, Two-Color Nylon Frame	FC14	+ \$35	

Single-color frame includes base, lumbar support band and arms.

Two-color frame includes fog frame with silver back support and silver base. Adjustable arms are silver. Fixed arms are fog.





UPHOLSTERED BACK TASK STOOL

4. Arms

Arm Style	Code	Price	
Armless	A0	- \$48	
Fixed Polyurethane	A140	- \$10	
Height-Adjustable	A141	+ \$0	
Multi-Adjustable (Height/Width)	A142	+ \$30	

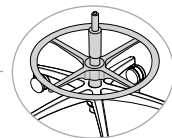
Arm color will match the frame. Arm pads are black except fixed polyurethane arm (A140) which matches frame color.

5. Base

Base	Code	Price	
Stool Kit	S1	+ \$0	
Extended Stool Kit	S2	+ \$24	
Base Color and Material	Code	Price	
Black Nylon Base (For Black Frame FC1)	B17	+ \$0	
Fog Nylon Base (For Fog Frame FC13)	B21	+ \$0	
Silver Nylon Base (For Fog Frame With Silver FC14)	B22	+ \$0	
Polished Aluminum Base	B18	+ \$113	

5. Base (Cont.)

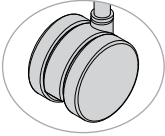
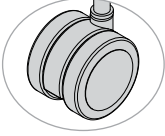
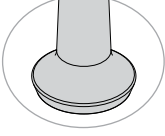
Casters or Glides	Code	Price	
Casters			
Black Carpet Casters	C16	+ \$0	
Black Hard Floor and Carpet Casters	C17	+ \$40	
Glides			
Glides for Task Chairs	C3	+ \$30	

Nylon bases pair only with their corresponding frame color. Polished aluminum base (B18) can be used with all frame colors.

6. Material

Protection	Code	Price	
Fire Retardancy			
CAL 133, Fabric, Quantities 1–49	133F	+ \$99	
CAL 133, Fabric, Quantities 50+	133F5	+ \$55	
CAL 133, Leather, Any Quantity	133L	+ \$119	
Seat and Back Textile	Code	Price	
Fabric/Vinyl Grade 1	FG1/VG1	+ \$0	
COM	COM	+ \$34	
Fabric/Vinyl Grade 2	FG2/VG2	+ \$34	
Fabric/Vinyl Grade 3	FG3/VG3	+ \$74	
Fabric/Vinyl Grade 4	FG4/VG4	+ \$121	
Fabric/Vinyl Grade 5	FG5/VG5	+ \$174	
Fabric/Vinyl Grade 6	FG6/VG6	+ \$235	
Fabric/Vinyl Grade 7	FG7/VG7	+ \$296	
Leather Grade 1	LG1	+ \$320	
COL	COL	+ \$420	
Leather Grade 2	LG2	+ \$420	
Leather Grade 3	LG3	+ \$540	

Please reference the [Textile Reference Guide](#) for pricing on fabric over grade 7 and leather over grade 3. Additional CAL 133 information can be found on [page 15](#).

Please reference the [Fabric information](#) found on [page 17](#) for pricing on multi-upholstery.

UPHOLSTERED BACK TASK STOOL

7. Packaging

Protection	Code	Price	
Knocked Down	KD	+ \$0	
Back Attached to Seat, Base Separate	UC	+ \$80	
Fully Assembled in a Carton	AC	+ \$200	

SPECIFICATIONS

	2723 B3 S1 Task Stool	2723 B3 S2 Extended Task Stool
Dimensions		
Overall Width Armless	24.5"	24.5"
Overall Width With Arms	27.75"–28.25"	27.75"–28.25"
Overall Depth	24.5"	24.5"
Overall Height	40.75"–48.25"	45.5"–55.13"
Seat Width	19.25"	19.25"
Seat Depth	17.75"	17.75"
Seat Height	21.5"–29.5"	25"–35"
Back Width	19.5"	19.5"
Back Height	22"	22"
Materials		
COM	1.25 yd	1.25 yd
COL	23 sq ft	23 sq ft
Weight and Capacity		
Weight Armless	35.5 lb	36 lb
Weight With Arms	40.5 lb	41 lb
Weight Capacity Warranty	300 lb	300 lb

Anytime

LIGHT TASK CHAIR AND STOOL

*Grab and go.
Anywhere.*

The Anytime™ light task chair and stool pair perfectly with the Anytime side chair to make a complete set. Featuring the versatility that is the signature of the collection along with a perforated shell and a built-in pull handle, Anytime makes any office, meeting or training room a workspace.



Featured Models

GOOD :: \$477

Task chair, all plastic, basic mechanism, armless, carpet casters

BETTER :: \$585

Task chair, plastic back and upholstered seat, swivel-tilt mechanism, armless, carpet casters



BEST :: \$701

Task chair, fully upholstered, swivel-tilt mechanism, fixed arms, carpet casters



Features

- Features
- Light task chair and light task stool
- Fully upholstered, upholstered seat only or plastic
- Three plastic colors
- Perforated shell provides ventilation
- Built-in pull handle
- Black tubular frame
- 250 lb weight capacity
- Complements Anytime multipurpose chair and bar stool; see [page 207](#)

1. Back

Seat and Back Style	Code	Price	
Plastic	No Code	\$527	
Upholstered Seat Only	US	\$585	
Upholstered Seat and Back	UP	\$643	



2. Mechanism

Mechanism Style	Code	Price	
Basic (Swivel Only)	B	- \$50	
Swivel-Tilt	T	+ \$0	



Swivel-tilt mechanism (T) is not available for task stool (S1) or extended task stool (S2).

LIGHT TASK CHAIR AND STOOL

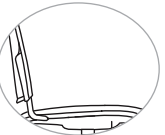

3. Frame

Frame Type	Code	Price	
Task Chair	93T	+ \$0	
Task Stool	93T S1	+ \$132	
Extended Task Stool	93T S2	+ \$156	

4. Arms

Arm Style	Code	Price	
Armless	A0	+ \$0	
Fixed Loop Arms	A48	+ \$58	

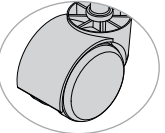
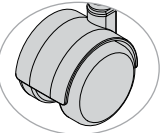
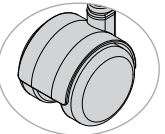
5. Base

Casters and Glides	Code	Price	
Casters			
Carpet Casters	C6	+ \$0	
Hard Floor and Carpet Casters	C1	+ \$40	
Self-Locking Carpet Casters	C2	+ \$30	
Self-Locking Hard Floor and Carpet Casters	C7	+ \$61	

Self-locking casters (C2/C7) lock only when not in use.

5. Base (Cont.)

Casters and Glides	Code	Price
Glides		
Glides for Task Chairs	C3	+ \$30

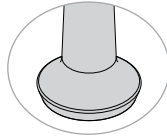

6. Material

Protection	Code	Price
Fire Retardancy		
CAL 133, Fabric, Quantities 1–49	133F	+ \$99
CAL 133, Fabric, Quantities 50+	133F5	+ \$55
CAL 133, Plastic, Any Quantity	133P	+ \$45
Shell Color	Code	Price
Black	SC1	+ \$0
Navy	SC5	+ \$0
Slate	SC8	+ \$0
Textile	Code	Price
Seat Textile Only (For US)		
Fabric/Vinyl Grade 1	FG1/VG1	+ \$0
COM	COM	+ \$22
Fabric/Vinyl Grade 2	FG2/VG2	+ \$22
Fabric/Vinyl Grade 3	FG3/VG3	+ \$45
Fabric/Vinyl Grade 4	FG4/VG4	+ \$77
Fabric/Vinyl Grade 5	FG5/VG5	+ \$116
Fabric/Vinyl Grade 6	FG6/VG6	+ \$159
Fabric/Vinyl Grade 7	FG7/VG7	+ \$200
Textile	Code	Price
Seat and Back Textile (For UP)		
Fabric/Vinyl Grade 1	FG1/VG1	+ \$0
COM	COM	+ \$34
Fabric/Vinyl Grade 2	FG2/VG2	+ \$34
Fabric/Vinyl Grade 3	FG3/VG3	+ \$74
Fabric/Vinyl Grade 4	FG4/VG4	+ \$121
Fabric/Vinyl Grade 5	FG5/VG5	+ \$174
Fabric/Vinyl Grade 6	FG6/VG6	+ \$235
Fabric/Vinyl Grade 7	FG7/VG7	+ \$296

Please reference the [Textile Reference Guide](#) for pricing on fabric over grade 7. Additional CAL 133 information can be found on [page 15](#).

Please reference the [Fabric information](#) found on [page 17](#) for pricing on multi-upholstery.

LIGHT TASK CHAIR AND STOOL

7. Packaging

Packaging	Code	Price
Back Attached to Seat, Base Separate	UC	+ \$0
Fully Assembled in a Carton	AC	+ \$120

SPECIFICATIONS

	93T Task	93T S1 Task Stool	93T S2 Extended Task Stool
Dimensions			
Overall Width Armless	26"	26"	26"
Overall Width With Arms	26.5"	26.5"	26.5"
Overall Depth	26"	26"	26"
Overall Height	35.5"	39"	43"
Seat Width	19"	19"	19"
Seat Depth	18"	18"	18"
Seat Height	16"-21"	19.6"-27"	23.5"-33.5"
Back Width	21.5"	21.5"	21.5"
Back Height	14.5"	14.5"	14.5"
Materials			
COM	0.8 yd (US) 1 yd (UP)	0.8 yd (US) 1 yd (UP)	0.8 yd (US) 1 yd (UP)
Weight and Capacity			
Weight Armless	29.5 lb	39.5 lb	39.5 lb
Weight With Arms	33.4 lb	44.4 lb	44.4 lb
Weight Capacity Warranty	250 lb	250 lb	250 lb

Focus

MESH BACK TASK CHAIR

Where comfort, style and ergonomics converge.

Experience something so comfortable it hardly ever crosses your mind—from the moment you sit down until it's time to head home. Our bestselling seating solution works just about anywhere you need thanks to a wider back frame, extra-deep seat and almost endless options to customize.

Our signature dual-curve frame takes its cues from modern, industrial design while also reinforcing key points of contact, so your back is optimally supported throughout the day.



EFFECTIVE OCTOBER 17, 2022

Featured Models

GOOD :: \$763

Midback, swivel-tilt mechanism, height-adjustable arms, nylon base, grade 1 textile

BETTER :: \$865

Highback, enhanced synchro mechanism, height-adjustable arms, nylon base, grade 1 textile

BEST :: \$1,060

Highback, adjustable lumbar, enhanced synchro mechanism with seat-depth adjustment, fully multi-adjustable (10-way) sport arms, nylon base, grade 1 textile

Features

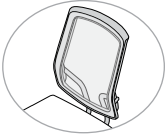
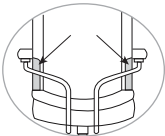

- Ergonomic back support and comfort
- Midback and highback
- Looser-weave mesh for extra breathability
- Five bleach-cleanable mesh colors
- Adjustable lumbar option
- Nine ergonomic arm styles with standard or sport arm pads
- Black or silver accents
- Waterfall seat
- Optional sport casters
- Complements Focus 2.0 task chair and Focus Side chair, counter and bar stool; see [page 74](#) and [page 222](#)
- Standard 300 lb weight capacity warranty; Super Duty Series: 350 lb and 400 lb weight capacity options

1. Back

Back Size and Style	Code	Price	
Midback Mesh	5622 B1	\$833	
Highback Mesh	5623 B1	\$865	
Back Options	Code	Price	
Adjustable Lumbar Support	LB1	+ \$50	



MESH BACK TASK CHAIR

2. Super Duty

Super Duty Series	Code	Price	
Heavy Duty	HD	+ \$126	
Large and Tall (Black Highback Frame With Enhanced Synchro Y Mechanism and Sport Height-Adjustable A152 Arms)	LT	+ \$250	

Heavy duty model (HD) is only available with enhanced synchro (Y) mechanism. Heavy Duty model (HD) is not available with fixed arms (A91). See the Super Duty Guide on [page 591](#) for additional LT and HD options.

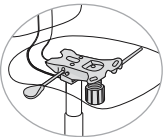
3. Mechanism

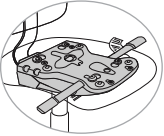
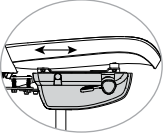
Mechanism Style	Code	Price	
Swivel-Tilt	T	- \$70	
Knee-Tilt	K	- \$57	
Enhanced Synchro	Y	+ \$0	
Enhanced Synchro Seat-Depth Adjustment	Y E3	+ \$79	

4. Frame

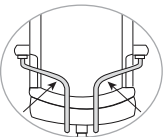
Back Support Color	Code	Price	
Black	Z1	+ \$0	
Silver	Z2	+ \$0	





5. Arms

Arm Style	Code	Price	
Armless	A0	- \$90	
Fixed Arms	A91	- \$15	
Height-Adjustable	A92	+ \$0	
Height-Adjustable With Sport Arm Pads	A152	+ \$0	
Height-/Width-Adjustable	A93	+ \$25	
Height-/Width-Adjustable With Sport Arm Pads	A153	+ \$25	
Fully Adjustable (6-Way)	A94	+ \$56	
Fully Adjustable (6-Way) With Sport Arm Pads	A154	+ \$56	
Fully Multi-Adjustable (10-Way)	A95	+ \$66	
Fully Multi-Adjustable (10-Way) With Sport Arm Pads	A155	+ \$66	

Fixed arms (A91) not available with enhanced synchro (Y) mechanism.

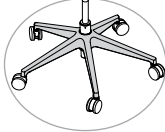
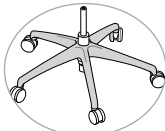
MESH BACK TASK CHAIR

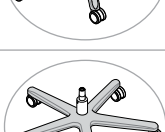
6. Base

Base Color and Style	Code	Price	
Black Nylon	B0	+ \$0	
High Profile Polished Aluminum Base	B3	+ \$113	
High Profile Brushed Aluminum Base	B8	+ \$113	
Low Profile Base With Higher Cylinder	S8	+ \$0	
Heavy Duty Bases (For HD/LT)			
Black Nylon Base, 26"	B7	+ \$0	
Polished Aluminum Base	B5	+ \$167	

Low profile base (S8) only available with enhanced synchro (Y) mechanism.

6. Base (Cont.)

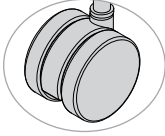
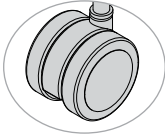
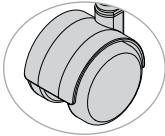
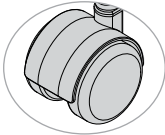
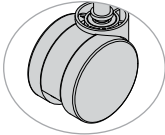
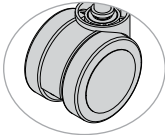
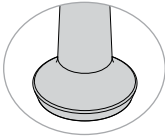
Casters or Glides	Code	Price	
Casters			
Carpet Casters	C15	+ \$0	
Sport Carpet Casters	C31	+ \$0	
Sport Hard Floor and Carpet Casters	C32	+ \$40	
Hard Floor and Carpet Casters	C14	+ \$40	
Self-Locking Carpet Casters	C20	+ \$30	
Self-Locking Hard Floor and Carpet Casters	C19	+ \$64	
Heavy Duty Casters (For HD and LT)			
Heavy Duty Carpet Casters	C11	+ \$0	
Heavy Duty Hard Floor and Carpet Casters	C9	+ \$61	
Glides			
Glides for Task Chairs	C3	+ \$30	

Self-locking casters (C19/C20) lock only when not in use.

MESH BACK TASK CHAIR

7. Material

Protection	Code	Price	
Fire Retardancy			
CAL 133, Fabric, Quantities 1-49	133F	+ \$99	
CAL 133, Fabric, Quantities 50+	133F5	+ \$55	
CAL 133, Leather, Any Quantity	133L	+ \$119	
Mesh Color			
Black	MC1	+ \$0	
Sand	MC3	+ \$0	
Slate	MC2	+ \$0	
Freeway Sport Stripe (Black/Slate)	MC33	+ \$0	
Impress Sport Stripe (Slate/Black)	MC34	+ \$0	
Seat Textile			
Fabric/Vinyl Grade 1	FG1/VG1	+ \$0	
COM	COM	+ \$26	
Fabric/Vinyl Grade 2	FG2/VG2	+ \$26	
Fabric/Vinyl Grade 3	FG3/VG3	+ \$60	
Fabric/Vinyl Grade 4	FG4/VG4	+ \$116	
Fabric/Vinyl Grade 5	FG5/VG5	+ \$172	
Fabric/Vinyl Grade 6	FG6/VG6	+ \$213	
Fabric/Vinyl Grade 7	FG7/VG7	+ \$254	
Leather Grade 1	LG1	+ \$300	
COL	COL	+ \$380	
Leather Grade 2	LG2	+ \$380	
Leather Grade 3	LG3	+ \$480	

Sport striped meshes list the predominant color first.

Please reference the [Textile Reference Guide](#) for pricing on fabric over grade 7 and leather over grade 3. Additional CAL 133 information can be found on [page 15](#).

8. Packaging

Packaging	Code	Price	
Knocked Down	KD	+ \$0	
Back Attached to Seat, Base Separate	UC	+ \$80	
Fully Assembled In a Carton	AC	+ \$200	

EFFECTIVE OCTOBER 17, 2022 | GSA SIN #: 33721

SPECIFICATIONS

	5622 B1 Midback Mesh Task Chair	5623 B1 Highback Mesh Task Chair	5623 B1 LT Highback Mesh Large and Tall Task Chair
Dimensions			
Overall Width Armless	26"	26"	26"
Overall Width With Arms	27.3"	27.5"	29"
Overall Depth	25"	26"	29"
Overall Height	35" 35.5" (B3/B8)	39" 39.5" (B3/B8)	38" (B7), 39" (B5)
Seat Width	19"	19"	22"
Seat Depth	18.5"-20.75"	18.5"-20.75"	17.5"
Seat Height	16.5"-20.125" (T) 17.5"-20.5" (K) 16.75"-20.75" (Y)	16.5"-20.125" (T) 17.5"-20.5" (K) 16.75"-20.75" (Y)	16.75"-19.75" (Y/B7) 16.88"-20.25" (Y/B5)
Back Width	18.25"	18.3"	18.3"
Back Height	20"	23.5"	21.5"
Materials			
COM	1 yd	1 yd	1.15 yd
COL	17 sq ft	17 sq ft	25 sq ft
Weight and Capacity			
Weight Armless	35.5 lb	36.5 lb	47 lb
Weight With Arms	41.5 lb	42.5 lb	53 lb
Weight Capacity	300 lb	300 lb	400 lb
Warranty	350 lb (HD)	350 lb (HD)	

Swivel-tilt mechanism (T). Knee-tilt mechanism (K). Enhanced synchro mechanism (Y). High profile polished aluminum base (B3). High profile brushed aluminum base (B8). Heavy Duty (HD). Heavy Duty black nylon base (B7). Heavy duty polished aluminum base (B5).



Better

Focus

MESH BACK TASK STOOL

Where comfort, style and ergonomics converge.

Experience something so comfortable it hardly ever crosses your mind—from the moment you sit down until it's time to head home. Our bestselling seating solution works just about anywhere you need thanks to a wider back frame, extra-deep seat and almost endless options to customize.

Our signature dual-curve frame takes its cues from modern, industrial design while also reinforcing key points of contact, so your back is optimally supported throughout the day.



EFFECTIVE OCTOBER 17, 2022

Featured Models

GOOD :: \$792

Midback mesh task stool, basic mechanism, armless, nylon base, grade 1 textile

BETTER :: \$914

Highback mesh task stool, basic mechanism, height-adjustable arms, nylon base, grade 1 textile

BEST :: \$1,054

Highback mesh task stool with adjustable lumbar support, basic mechanism, 10-way arms with sport pads, extended stool kit, nylon base, grade 1 textile

Features

- Ergonomic back support and comfort
- Midback and highback
- Looser-weave mesh for extra breathability
- Five bleach-cleanable mesh colors
- Adjustable lumbar option
- Nine ergonomic arm styles with standard or Sport arm pads
- Black or silver accents
- Waterfall seat
- Optional Sport casters
- Complements Focus 2.0 task chair and Focus Side chair, counter and bar stool; see [page 74](#) and [page 222](#)
- Standard 300 lb weight capacity warranty

1. Back

Back Size and Style	Code	Price	
---------------------	------	-------	--

Midback Mesh	5622 B1	\$882	
--------------	---------	-------	---

Highback Mesh	5623 B1	\$914	
---------------	---------	-------	---

Back Options	Code	Price	
--------------	------	-------	--

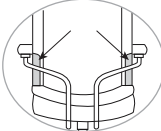
Adjustable Lumbar Support	LB1	+ \$50	
---------------------------	-----	--------	---

MESH BACK TASK STOOL

2. Mechanism

Mechanism Style	Code	Price	
-----------------	------	-------	--

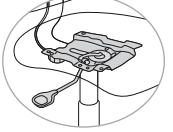
Basic (Swivel Only)	B	+\$0	
---------------------	---	------	---

3. Frame

Back Support Color	Code	Price	
--------------------	------	-------	--

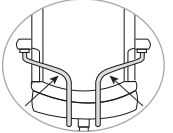
Black	Z1	+\$0	
Silver	Z2	+\$0	





Good

4. Arms

Arm Style	Code	Price	
Armless	A0	- \$90	
Fixed Arms	A91	- \$15	
Height-Adjustable	A92	+ \$0	
Height-Adjustable With Sport Arm Pads	A152	+ \$0	
Height-/Width-Adjustable	A93	+ \$25	
Height-/Width-Adjustable With Sport Arm Pads	A153	+ \$25	
Fully Adjustable (6-Way)	A94	+ \$56	
Fully Adjustable (6-Way) With Sport Arm Pads	A154	+ \$56	
Fully Multi-Adjustable (10-Way)	A95	+ \$66	
Fully Multi-Adjustable (10-Way) With Sport Arm Pads	A155	+ \$66	

MESH BACK TASK STOOL

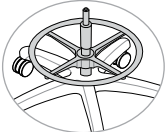
5. Base

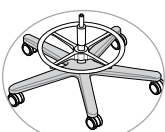
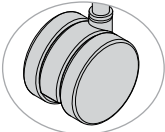
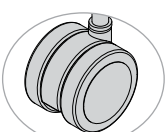
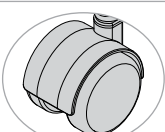
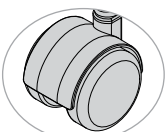
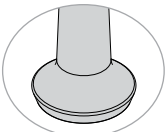
Base	Code	Price	
Stool Kit	S1	+ \$0	
Extended Stool Kit	S2	+ \$24	
Base Color and Material	Code	Price	
Black Nylon Base	B6	+ \$0	
Polished Aluminum Base	B5	+ \$167	
Casters or Glides	Code	Price	
Casters			
Carpet Casters	C5	+ \$0	
Carpet Casters (For Higher Cylinder)	C21	+ \$0	
Sport Carpet Casters	C31	+ \$0	
Sport Hard Floor and Carpet Casters	C32	+ \$40	
Hard Floor and Carpet Casters	C1	+ \$40	
Hard Floor and Carpet Casters (For Higher Cylinder)	C22	+ \$40	
Self-Locking Carpet Casters	C2	+ \$30	
Self-Locking Hard Floor and Carpet Casters	C7	+ \$61	
Glides			
Glides for Task Chairs	C3	+ \$30	

Self-locking casters (C2/C7) lock only when not in use.

6. Material

Protection	Code	Price
Fire Retardancy		
CAL 133, Fabric, Quantities 1–49	133F	+ \$99
CAL 133, Fabric, Quantities 50+	133F5	+ \$55
CAL 133, Leather, Any Quantity	133L	+ \$119
Mesh Color	Code	Price
Black	MC1	+ \$0
Sand	MC3	+ \$0
Slate	MC2	+ \$0
Freeway Sport Stripe (Black/Slate)	MC33	+ \$0
Impress Sport Stripe (Slate/Black)	MC34	+ \$0
Seat Textile	Code	Price
Fabric/Vinyl Grade 1	FG1/VG1	+ \$0
COM	COM	+ \$26
Fabric/Vinyl Grade 2	FG2/VG2	+ \$26
Fabric/Vinyl Grade 3	FG3/VG3	+ \$60
Fabric/Vinyl Grade 4	FG4/VG4	+ \$116
Fabric/Vinyl Grade 5	FG5/VG5	+ \$172
Fabric/Vinyl Grade 6	FG6/VG6	+ \$213
Fabric/Vinyl Grade 7	FG7/VG7	+ \$254
Leather Grade 1	LG1	+ \$300
COL	COL	+ \$380
Leather Grade 2	LG2	+ \$380
Leather Grade 3	LG3	+ \$480

Sport striped meshes list the predominant color first.

Please reference the [Textile Reference Guide](#) for pricing on fabric over grade 7 and leather over grade 3. Additional CAL 133 information can be found on [page 15](#).

7. Packaging

Packaging	Code	Price
Knocked Down	KD	+ \$0
Back Attached to Seat, Base Separate	UC	+ \$80
Fully Assembled in a Carton	AC	+ \$200

MESH BACK TASK STOOL

MIDBACK SPECIFICATIONS

	5622 B1 S1 Midback Task Stool	5622 B1 S2 Midback Extended Task Stool
Dimensions		
Overall Width Armless	27.3"	27.3"
Overall Width With Arms	27.3"	27.3"
Overall Depth	25"	25"
Overall Height	41.6"	46"
Seat Width	19"	19"
Seat Depth	18.5"	18.5"
Seat Height	21"–29"	24"–34"
Back Width	18.25"	18.25"
Back Height	20"	20"
Materials		
COM	1 yd	1 yd
COL	17 sq ft	17 sq ft
Weight and Capacity		
Weight Armless	39.5 lb	40.5 lb
Weight With Arms	45.5 lb	46.5 lb
Weight Capacity Warranty	300 lb	300 lb

HIGHBACK SPECIFICATIONS

	5623 B1 S1 Highback Task Stool	5623 B1 S2 Highbackw Extended Task Stool
Dimensions		
Overall Width Armless	20"	20"
Overall Width With Arms	27.5"	27.5"
Overall Depth	26"	26"
Overall Height	45"	50"
Seat Width	20"	20"
Seat Depth	18.5"	18.5"
Seat Height	21"–29"	24"–34"
Back Width	18.3"	18.3"
Back Height	23.5"	23.5"
Materials		
COM	1 yd	1 yd
COL	17 sq ft	17 sq ft
Weight and Capacity		
Weight Armless	40.5 lb	41.5 lb
Weight With Arms	46.5 lb	47.5 lb
Weight Capacity Warranty	300 lb	300 lb

Focus

UPHOLSTERED BACK TASK CHAIR

Where comfort, style and ergonomics converge.

Experience something so comfortable it hardly ever crosses your mind—from the moment you sit down until it's time to head home. Our bestselling seating solution works just about anywhere you need thanks to a wider back frame, extra-deep seat and almost endless options to customize.

Our signature dual-curve frame takes its cues from modern, industrial design while also reinforcing key points of contact, so your back is optimally supported throughout the day.



EFFECTIVE OCTOBER 17, 2022

Featured Models

GOOD :: \$889

Midback upholstered pad, swivel-tilt mechanism, height-adjustable arms, nylon base, carpet casters, grade 1 textile

BETTER :: \$991

Highback upholstered pad, enhanced synchro mechanism, height-adjustable sport arm pads, nylon base, carpet casters grade 1 textile

BEST :: \$1,186

Highback upholstered pad, adjustable lumbar, enhanced synchro mechanism with seat-depth adjustment, fully multi-adjustable (10-way) sport arm pads, nylon base, carpet casters, grade 1 textile

Features

- Ergonomic back support and comfort
- Midback and highback
- Relaxed-fit upholstered pad
- Adjustable lumbar option
- Nine ergonomic arm styles with standard or Sport arm pads
- Black or silver accents
- Waterfall seat
- Optional Sport casters
- Complements Focus 2.0 task chair and Focus Side chair, counter and bar stool; see [page 74](#) and [page 222](#)
- Standard 300 lb weight capacity warranty; Heavy Duty Series - 350 lb and 400 lb weight capacities

1. Back

Back Size and Style	Code	Price
---------------------	------	-------

Midback Relaxed-Fit Upholstered Pad

5622 B4

\$959



Highback Relaxed-Fit Upholstered Pad

5623 B4

\$991



Back Options	Code	Price
--------------	------	-------

Adjustable Lumbar Support

LB1

+ \$50

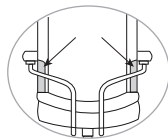

UPHOLSTERED BACK TASK CHAIR

2. Heavy Duty

Heavy Duty Series	Code	Price
-------------------	------	-------

Heavy Duty

HD

+ \$126



Large and Tall
(Black Highback Frame With Enhanced Synchro Y Mechanism and Sport Height-Adjustable A152 Arms)

LT

+ \$250



Heavy Duty model (HD) only available with enhanced synchro (Y) mechanism. See [page 591](#) for additional options Heavy Duty and Large and Tall options.

3. Mechanism

Mechanism	Code	Price
-----------	------	-------

Swivel-Tilt

T

- \$70



Knee-Tilt

K

- \$57



Enhanced Synchro

Y

+ \$0

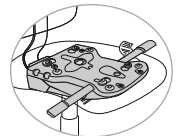

Enhanced Synchro With Seat-Depth Adjustment

Y E3

+ \$79

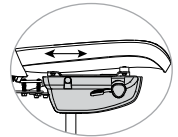

4. Frame

Back Support Color	Code	Price
--------------------	------	-------

Black

Z1

+ \$0

Silver

Z2

+ \$0

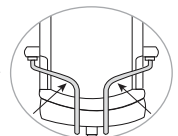





5. Arms

Arm Style	Code	Price	
Armless	A0	- \$90	
Fixed Arms	A91	- \$15	
Height-Adjustable	A92	+ \$0	
Height-Adjustable With Sport Arm Pads	A152	+ \$0	
Height-/Width-Adjustable	A93	+ \$25	
Height-/Width-Adjustable With Sport Arm Pads	A153	+ \$25	
Fully Adjustable (6-Way)	A94	+ \$56	
Fully Adjustable (6-Way) With Sport Arm Pads	A154	+ \$56	
Fully Multi-Adjustable (10-Way)	A95	+ \$66	
Fully Multi-Adjustable (10-Way) With Sport Arm Pads	A155	+ \$66	

Fixed arms (A91) are not available with the enhanced synchro (Y) mechanism.

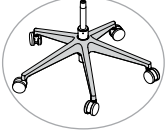
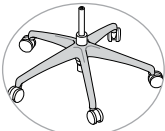
UPHOLSTERED BACK TASK CHAIR

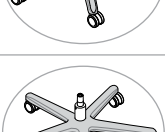
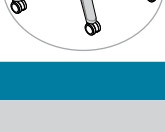
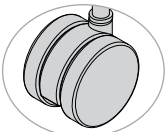
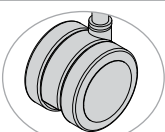
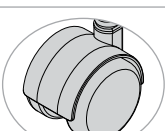
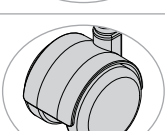
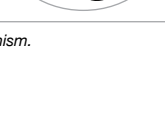
6. Base

Base and Color	Code	Price	
Black Nylon Base	B0	+ \$0	
High Profile Polished Aluminum Base	B3	+ \$113	
High Profile Brushed Aluminum Base	B8	+ \$113	
Low Profile Nylon Base With Higher Cylinder	S8	+ \$0	
Heavy Duty Bases (For HD/LT)			
Black Nylon Base, 26"	B7	+ \$0	
Polished Aluminum	B5	+ \$167	
Casters or Glides	Code	Price	
Casters			
Carpet Casters	C15	+ \$0	
Sport Carpet Casters	C31	+ \$0	
Sport Hard Floor and Carpet Casters	C32	+ \$40	
Hard Floor and Carpet Casters	C14	+ \$40	
Self-Locking Carpet Casters	C20	+ \$30	
Self-Locking Hard Floor and Carpet Casters	C19	+ \$64	

Low profile base (S8) only available with enhanced synchro (Y) mechanism.
Heavy Duty bases (B5/B7) are for use with the HD and LT models.

6. Base (Cont.)

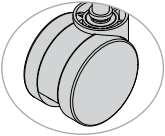
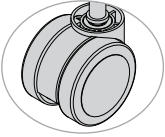
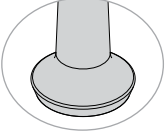
Casters or Glides	Code	Price	
Heavy Duty Casters (For HD and LT)			
Heavy Duty Carpet Casters	C11	+ \$0	
Heavy Duty Hard Floor and Carpet Casters	C9	+ \$61	
Glides			
Glides for Task Chairs	C3	+ \$30	

Self-locking casters (C20/C19) lock only when not in use.

7. Material

Protection	Code	Price	
Fire Retardancy			
CAL 133, Fabric, Quantities 1-49	133F	+ \$99	
CAL 133, Fabric, Quantities 50+	133F5	+ \$55	
CAL 133, Leather, Any Quantity	133L	+ \$119	
Seat and Back Textile	Code	Price	
Fabric/Vinyl Grade 1	FG1/VG1	+ \$0	
COM	COM	+ \$34	
Fabric/Vinyl Grade 2	FG2/VG2	+ \$34	
Fabric/Vinyl Grade 3	FG3/VG3	+ \$74	
Fabric/Vinyl Grade 4	FG4/VG4	+ \$121	
Fabric/Vinyl Grade 5	FG5/VG5	+ \$174	
Fabric/Vinyl Grade 6	FG6/VG6	+ \$235	
Fabric/Vinyl Grade 7	FG7/VG7	+ \$296	
Leather Grade 1	LG1	+ \$260	
COL	COL	+ \$320	
Leather Grade 2	LG2	+ \$320	
Leather Grade 3	LG3	+ \$400	

Please reference the [Textile Reference Guide](#) for pricing on fabric over grade 7 and leather over grade 3. Additional CAL 133 information can be found on [page 15](#).

Please reference the [Fabric](#) information found on [page 17](#) for pricing on multi-upholstery.

UPHOLSTERED BACK TASK CHAIR

8. Packaging

Base and Color and Material	Code	Price	
Knocked Down	KD	+ \$0	
Back Attached to Seat, Base Separate	UC	+ \$80	
Fully Assembled in a Carton	AC	+ \$200	



Better

EFFECTIVE OCTOBER 17, 2022 | GSA SIN #: 33721

SPECIFICATIONS

	5622 B4 Midback Task Chair	5623 B4 Highback Task Chair	5623 B4 LT Large and Tall Task Chair
Dimensions			
Overall Width Armless	26"	26"	26"
Overall Width With Arms	27.3"	27.5"	29"
Overall Depth	25"	26"	27.75"
Overall Height	35" (B0), 35.5" (B3/B8)	39" (B0), 39.5" (B3/B8)	38.5" (B7), 39.75" (B5)
Seat Width	19"	19"	22"
Seat Depth	18.5"-20.75"	18.5"-20.75"	17.5"
Seat Height	16.5"-20.125" (T) 17.5"-20.5" (K) 16.75"-20.75" (Y)	16.5"-20.125" (T) 17.5"-20.5" (K) 16.75"-20.75" (Y)	17.5"-21.5" (Y) (B7)
	16.88"-20.25" (Y) (B3/B8)	16.88"-20.25" (Y) (B3/B8)	16.88"-20.25" (Y) (B5)
Back Width	18.25"	18.3"	18.3"
Back Height	20"	23.5"	21.5"
Materials			
COM	1.15 yd	1.25 yd	1.25 yd
COL	23 sq ft	25 sq ft	31 sq ft
Weight and Capacity			
Weight Armless	35.5 lb	36.5 lb	47 lb
Weight With Arms	41.5 lb	42.5 lb	53 lb
Weight Capacity	300 lb	300 lb	400 lb
Warranty	350 lb (HD)	350 lb (HD)	

Swivel tilt mechanism (T). Knee tilt mechanism (K). Enhanced synchro mechanism (Y). High profile polished aluminum base (B3). High profile brushed aluminum base (B8). Heavy Duty (HD). Heavy Duty black nylon base (B7). Heavy Duty polished aluminum base (B5).



Focus

UPHOLSTERED BACK TASK STOOL

Where comfort, style and ergonomics converge.

Experience something so comfortable it hardly ever crosses your mind— from the moment you sit down until it's time to head home. Our bestselling seating solution works just about anywhere you need thanks to a wider back frame, extra-deep seat and almost endless options to customize.

Our signature dual-curve frame takes its cues from modern, industrial design while also reinforcing key points of contact, so your back is optimally supported throughout the day. Plus, a built-in lumbar system helps promote correct posture so that you spend more time working and less time (re)adjusting your seat.



Best

EFFECTIVE OCTOBER 17, 2022

Featured Models

GOOD :: \$918

Midback upholstered, task stool, basic mechanism, armless, black nylon base, grade 1 textile

BETTER :: \$1,040

Highback upholstered, task stool, basic mechanism, height-adjustable arms, black nylon base, grade 1 textile

BEST :: \$1,180

Highback upholstered, task stool, adjustable lumbar support, basic mechanism, fully multi-adjustable (10-way) sport arms, extended stool kit, black nylon base, grade 1 textile

Features

- Ergonomic back support and comfort
- Midback and highback
- Relaxed-fit upholstered pad
- Adjustable lumbar option
- Nine ergonomic arm styles with standard or Sport arm pads
- Black or silver accents
- Waterfall seat
- Optional Sport casters
- Complements Focus 2.0 task chair and Focus Side chair, counter and bar stool; see [page 74](#) and [page 222](#)
- Standard 300 lb weight capacity warranty

1. Back

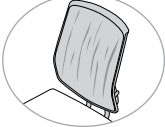
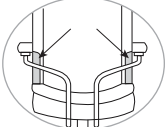
Back Size and Style	Code	Price	
Midback Relaxed-Fit Upholstered Pad	5622 B4	\$1,008	
Highback Relaxed-Fit Upholstered Pad	5623 B4	\$1,040	
Back Options	Code	Price	
Adjustable Lumbar Support	LB1	+ \$50	

UPHOLSTERED BACK TASK STOOL

2. Mechanism

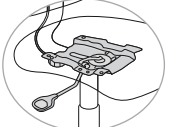
Mechanism	Code	Price	
Basic (Swivel Only)	B	+\$0	

3. Frame

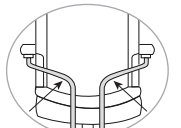
Back Support Color	Code	Price	
Black	Z1	+ \$0	
Silver	Z2	+ \$0	





4. Arms

Arm Style	Code	Price	
Armless	A0	- \$90	
Fixed Arms	A91	- \$15	
Height-Adjustable	A92	+ \$0	
Height-Adjustable With Sport Arm Pads	A152	+ \$0	
Height-/Width-Adjustable	A93	+ \$25	
Height-/Width-Adjustable With Sport Arm Pads	A153	+ \$25	
Fully Adjustable (6-Way)	A94	+ \$56	
Fully Adjustable (6-Way) With Sport Arm Pads	A154	+ \$56	
Fully Multi-Adjustable (10-Way)	A95	+ \$66	
Fully Multi-Adjustable (10-Way) With Sport Arm Pads	A155	+ \$66	

Fixed arms (A91) are not available with the enhanced synchro (Y) mechanism.

UPHOLSTERED BACK TASK STOOL

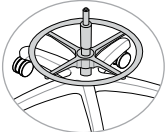
5. Base

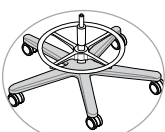
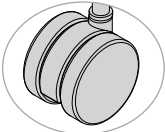
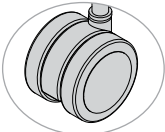
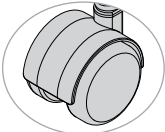
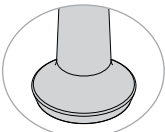
Base	Code	Price	
Stool Kit	S1	+ \$0	
Extended Stool Kit	S2	+ \$24	
Base Color and Material	Code	Price	
Black Nylon Base	B6	+ \$0	
Polished Aluminum Base	B5	+ \$167	
Casters or Glides	Code	Price	
Casters			
Carpet Casters	C5	+ \$0	
Carpet Casters (For Higher Cylinder Only)	C21	+ \$0	
Sport Carpet Casters	C31	+ \$0	
Sport Hard Floor and Carpet Casters	C32	+ \$40	
Hard Floor and Carpet Casters	C1	+ \$40	
Hard Floor and Carpet Casters (For Higher Cylinder Only)	C22	+ \$40	
Self-Locking Carpet Casters	C2	+ \$30	
Self-Locking Hard Floor and Carpet Casters	C7	+ \$61	
Glides			
Glides for Task Chairs	C3	+ \$30	

Self-locking casters (C2/C7) lock only when not in use.

6. Material

Protection	Code	Price
Fire Retardancy		
CAL 133, Fabric, Quantities 1–49	133F	+ \$99
CAL 133, Fabric, Quantities 50+	133F5	+ \$55
CAL 133, Leather, Any Quantity	133L	+ \$119
Seat and Back Textile	Code	Price
COM	FG1/VG1	+ \$0
Fabric/Vinyl Grade 1	COM	+ \$34
Fabric/Vinyl Grade 2	FG2/VG2	+ \$34
Fabric/Vinyl Grade 3	FG3/VG3	+ \$74
Fabric/Vinyl Grade 4	FG4/VG4	+ \$121
Fabric/Vinyl Grade 5	FG5/VG5	+ \$174
Fabric/Vinyl Grade 6	FG6/VG6	+ \$235
Fabric/Vinyl Grade 7	FG7/VG7	+ \$296
Leather Grade 1	LG1	+ \$260
COL	COL	+ \$320
Leather Grade 2	LG2	+ \$320
Leather Grade 3	LG3	+ \$400

Please reference the [Textile Reference Guide](#) for pricing on fabric over grade 7 and leather over grade 3. Additional CAL 133 information can be found on [page 15](#).

Please reference the [Fabric information](#) found on [page 17](#) for pricing on multi-upholstery.

7. Packaging

Packaging	Code	Price
Knocked Down	KD	+ \$0
Back Attached to Seat, Base Separate	UC	+ \$80
Fully Assembled in a Carton	AC	+ \$200

UPHOLSTERED BACK TASK STOOL

MIDBACK SPECIFICATIONS

	5622 B4 S1 Upholstered Task Stool	5622 B4 S2 Upholstered Extended Task Stool
Dimensions		
Overall Width Armless	27.3"	27.3"
Overall Width With Arms	27.3"	27.3"
Overall Depth	25"	25"
Overall Height	41.6"	46"
Seat Width	19"	19"
Seat Depth	18.5"	18.5"
Seat Height	21"–29"	24"–34"
Back Width	18.25"	18.25"
Back Height	20"	20"
Materials		
COM	1.15 yd	1.15 yd
COL	23 sq ft	23 sq ft
Weight and Capacity		
Weight Armless	39.5 lb	40.5 lb
Weight With Arms	45.5 lb	46.5 lb
Weight Capacity	300 lb	300 lb

HIGHBACK SPECIFICATIONS

	5623 B4 S1 Upholstered Task Stool	5623 B4 S2 Upholstered Extended Task Stool
Dimensions		
Overall Width Armless	20"	20"
Overall Width With Arms	27.5"	27.5"
Overall Depth	26"	26"
Overall Height	45"	50"
Seat Width	20"	20"
Seat Depth	18.5"	18.5"
Seat Height	21"–29"	24"–34"
Back Width	18.3"	18.3"
Back Height	23.5"	23.5"
Materials		
COM	1.15 yd	1.15 yd
COL	23 sq ft	23 sq ft
Weight and Capacity		
Weight Armless	40.5 lb	41.5 lb
Weight With Arms	46.5 lb	47.5 lb
Weight Capacity	300 lb	300 lb

Focus 2.0

MESH BACK TASK CHAIR

Focus reimagined.

Focus™ 2.0 is more than a makeover. It's a modernization. It's driving dependable design forward with innovative mesh, enhanced (and expanded) customization, advanced functionality and a slimmer silhouette that offers superior comfort from integrated lumbar support and cutting-edge ergonomics. Focus 2.0 is everything you loved in the first generation and more.



EFFECTIVE OCTOBER 17, 2022

Featured Models

GOOD :: \$703

Midback mesh with adjustable lumbar support, swivel-tilt mechanism, height-adjustable arms, black frame, black nylon Y-support, black nylon base, accent color, carpet casters, grade 1 textile

BETTER :: \$826

Highback mesh with adjustable lumbar support, enhanced synchro mechanism, height-/width-adjustable (4-way) arms, black frame, black nylon Y-support, black nylon base, accent color, carpet casters, grade 1 textile

BEST :: \$1,000

Highback mesh with adjustable lumbar support, enhanced synchro mechanism with seat-depth adjustment, fully adjustable (8-way) arms, white frame, piano black Y-support, white nylon base, accent color, carpet casters, grade 1 textile



FOCUS 2.0

EFFECTIVE OCTOBER 17, 2022 | GSA SIN #: 33721

Features

- Slimmer, refined design
- Swivel-tilt and enhanced synchro mechanism
- Optional seat-depth adjustment
- Modernized Y-support customizable in four colors, including piano black
- Three frame and four base colors
- Armless, fixed, height-adjustable, height-/width-adjustable or fully adjustable arms
- 12 accent colors for pull handle stripe, lumbar casing, arm adjustment and caster rings
- Three exclusive mesh options in Focus mesh, Focus 2.0 mesh and Focus Uptown mesh
- Adjustable lumbar support included
- Performance casters color coordinate with frame and base
- Complements Focus task chair and stool and Focus Side chair, counter and bar stool; see [page 56](#) and [page 222](#)
- 300 lb weight capacity warranty

1. Back



Back Size and Style	Code	Price	
Midback Mesh With Adjustable Lumbar	1123 BK1 MB	\$773	
Highback Mesh With Adjustable Lumbar	1123 BK2 MB	\$801	

MESH BACK TASK CHAIR

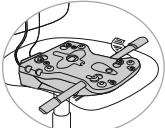
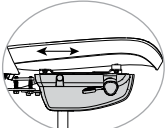
2. Mechanism

Mechanism Style	Code	Price	
Swivel-Tilt	T	- \$70	
Enhanced Synchro	Y	+ \$0	
Enhanced Synchro With Seat-Depth Adjustment	Y/E3	+ \$79	



3. Frame

Frame Color	Code	Price	
Black	FC1	+ \$0	
Fog	FC13	+ \$35	
White	FC12	+ \$35	
Y-Support Color	Code	Price	
Black	YCC01	+ \$0	
White	YCC02	+ \$0	
Fog	YCC03	+ \$0	
Piano Black	YCC04	+ \$25	

FOCUS 2.0

EFFECTIVE OCTOBER 17, 2022 | GSA SIN #: 33721

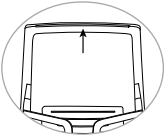
3. Frame (Cont.)

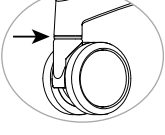
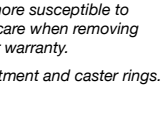

Accent Color	Code	Price	
Apple	LA12	+ \$0	
Desert	LA3	+ \$0	
Electric Blue	LA5	+ \$0	
Fire	LA6	+ \$0	
Fog	LA4	+ \$0	
Graphite	LA14	+ \$0	
Navy	LA15	+ \$0	
Nickel	LA2	+ \$0	
Ocean	LA10	+ \$0	
Onyx	LA1	+ \$0	
Tangerine	LA9	+ \$0	
White	LA13	+ \$0	

Due to the high-gloss material, the piano black Y-support (YCC04) is more susceptible to scratches and scuffs in a workstation environment and requires more care when removing protective packaging. Scratches and scuffs may not be covered under warranty.

Accent color is applied to pull handle stripe, lumbar casing, arm adjustment and caster rings.

MESH BACK TASK CHAIR

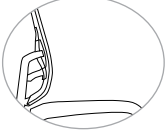
4. Arms

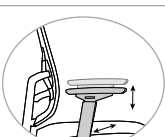
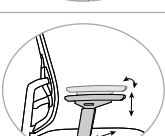
Arm Style	Code	Price	
Armless	AR0	- \$48	
Fixed Arms	AR2	- \$10	
Height-Adjustable	AR4	+ \$0	
Height-/Width-Adjustable (4-Way)	AR6	+ \$25	
Fully Adjustable (8-Way)	AR9	+ \$60	

Arms, if specified, come with fog arm pads for the white (FC12) and fog (FC13) frames and black arm pads for the black frame (FC1).

5. Base

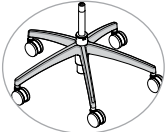
Base Style	Code	Price	
5-Star Nylon	BT1	+ \$0	
5-Star Polished Aluminum	BT2	+ \$113	

Nylon Base Color	Code	Price	
Black Nylon Base	BC1	+ \$0	
Fog Nylon Base	BC4	+ \$0	
White Nylon Base	BC3	+ \$0	

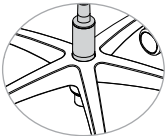
Cylinder Height	Code	Price	
Higher Cylinder	CH3	+ \$0	
Standard Cylinder	CH1	+ \$0	

FOCUS 2.0

EFFECTIVE OCTOBER 17, 2022 | GSA SIN #: 33721

5. Base (Cont.)

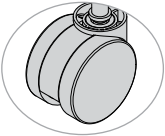
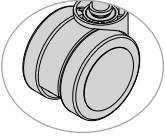
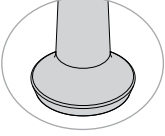
Casters or Glides	Code	Price	
Casters			
Carpet Casters	CS5	+ \$0	
Hard Floor and Carpet Casters	CS6	+ \$40	
Glides			
Glides for Task Chairs	CS3	+ \$30	

6. Material

Mesh	Code	Price	
Focus 2.0 Mesh			
Apple	MC31	+ \$0	
Desert	MC9	+ \$0	
Electric Blue	MC13	+ \$0	
Fire	MC10	+ \$0	
Fog	MC7	+ \$0	
Navy	MC8	+ \$0	
Nickel	MC6	+ \$0	
Ocean	MC29	+ \$0	
Onyx	MC5	+ \$0	
Tangerine	MC28	+ \$0	
Focus 2.0 Uptown Mesh			
Midnight	MC43	+ \$0	
Charcoal	MC44	+ \$0	
Ash	MC45	+ \$0	
Dune	MC46	+ \$0	
Focus Mesh			
Black	MC1	+ \$0	
Sand	MC3	+ \$0	
Slate	MC2	+ \$0	
Freeway Sport Stripe (Black/Slate)	MC33	+ \$0	
Impress Sport Stripe (Slate/Black)	MC34	+ \$0	

Sport striped meshes list the predominant color first.

MESH BACK TASK CHAIR

6. Material (Cont.)

Seat Textile	Code	Price	
Fabric/Vinyl Grade 1	FG1/VG1	+ \$0	
COM	COM	+ \$26	
Fabric/Vinyl Grade 2	FG2/VG2	+ \$26	
Fabric/Vinyl Grade 3	FG3/VG3	+ \$60	
Fabric/Vinyl Grade 4	FG4/VG4	+ \$116	
Fabric/Vinyl Grade 5	FG5/VG5	+ \$172	
Fabric/Vinyl Grade 6	FG6/VG6	+ \$213	
Fabric/Vinyl Grade 7	FG7/VG7	+ \$254	
Leather Grade 1	LG1	+ \$300	
COL	COL	+ \$380	
Leather Grade 2	LG2	+ \$380	
Leather Grade 3	LG3	+ \$480	

Please reference the [Textile Reference Guide](#) for pricing on fabric over grade 7 and leather over grade 3.

FOCUS 2.0

MESH BACK TASK CHAIR

EFFECTIVE OCTOBER 17, 2022 | GSA SIN #: 33721

7. Packaging

Mesh	Code	Price
Knocked Down	KD	+ \$0
Back Attached to Seat, Base Separate	UC	+ \$80
Fully Assembled in a Carton	AC	+ \$200

SPECIFICATIONS

	1123 BK1 MB Midback Mesh Task Chair	1123 BK2 MB Highback Mesh Task Chair
Dimensions		
Overall Width Without Arms	26"	26"
Overall Width With Arms	28.5"	28.5"
Overall Depth	28"	26"
Overall Height	33.25"-36.75"	36.25"-39.75"
Seat Width	19.5"	19.5"
Seat Depth	17.7"-19.6" 16.75"-19.25" (Y/E3)	17.7"-19.6" 16.75"-19.25" (Y/E3)
Seat Height	16.6"-20.1" (T) 16.9"-20.4" (Y)	16.6"-20.1" (T) 16.9"-20.4" (Y)
Seat Height With Higher Cylinder	17.1"-22.3" (T) 17.4"-22.6" (Y)	17.1"-22.3" (T) 17.4"-22.6" (Y)
Back Width	18.5"	18.5"
Back Height	19.5"	22.5"
Materials		
COM	1 yd	1 yd
COL	14 sq ft	14 sq ft
Weight and Capacity		
Weight Armless	31 lb	32 lb
Weight With Arms	37 lb	38 lb
Weight Capacity Warranty	300 lb	300 lb

Swivel-tilt mechanism (T), Enhanced synchro mechanism (Y), Enhanced synchro with seat-depth adjustment (Y/E3)



Best

Focus 2.0

MESH BACK TASK STOOL

Focus reimagined.

Focus™ 2.0 is more than a makeover. It's a modernization. It's driving dependable design forward with innovative mesh, enhanced (and expanded) customization, advanced functionality and a slimmer silhouette that offers superior comfort from integrated lumbar support and cutting-edge ergonomics. Focus 2.0 is everything you loved in the first generation and more.



EFFECTIVE OCTOBER 17, 2022

Featured Models

GOOD :: \$802

Midback mesh with adjustable lumbar support, basic mechanism, black frame, black Y-support, armless, standard stool kit, nylon base, carpet casters, grade 1 textile

BETTER :: \$885

Midback mesh with adjustable lumbar support, basic mechanism, white frame, white Y-support, height-adjustable arms, standard stool kit, nylon base, carpet casters, grade 1 textile

BEST :: \$1,048

Midback mesh with adjustable lumbar support, basic mechanism, fully adjustable (8-way) arms, black frame, piano black Y-support, polished aluminum base, carpet casters, grade 1 textile

FOCUS 2.0

EFFECTIVE OCTOBER 17, 2022 | GSA SIN #: 33721

Features

- Slimmer, refined design
- Basic mechanism
- Modernized Y-support customizable in four colors, including piano black
- Three frame and four base colors
- Armless, fixed, height-adjustable, height-/width-adjustable or fully adjustable arms
- 12 accent colors for pull handle stripe, lumbar casing, arm adjustment and caster rings
- Three exclusive mesh options in Focus mesh, Focus 2.0 mesh and Focus Uptown mesh
- Adjustable lumbar support included
- Performance casters color coordinate with frame and base
- Complements Focus task chair and stool and Focus Side chair, counter and bar stool; see [page 56](#) and [page 222](#)
- 300 lb weight capacity warranty

1. Back

Back Size and Style	Code	Price	
Midback Mesh With Adjustable Lumbar	1123 BK1 MB	\$850	

2. Mechanism



Mechanism Style	Code	Price	
Basic (Swivel Only)	B	+ \$0	

MESH BACK TASK STOOL

3. Frame

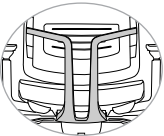
Frame Color	Code	Price	
Black	FC1	+ \$0	
Fog	FC13	+ \$35	
White	FC12	+ \$35	

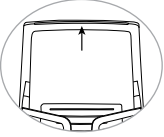
Y-Support Color	Code	Price	
Black	YCC01	+ \$0	
White	YCC02	+ \$0	
Fog	YCC03	+ \$0	
Piano Black	YCC04	+ \$25	

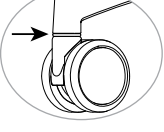
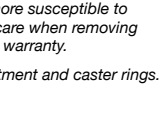
Accent Color	Code	Price	
Apple	LA12	+ \$0	
Desert	LA3	+ \$0	
Electric Blue	LA5	+ \$0	
Fire	LA6	+ \$0	
Fog	LA4	+ \$0	
Graphite	LA14	+ \$0	
Navy	LA15	+ \$0	
Nickel	LA2	+ \$0	
Ocean	LA10	+ \$0	
Onyx	LA1	+ \$0	
Tangerine	LA9	+ \$0	
White	LA13	+ \$0	



Due to the high-gloss material, the piano black Y-support (YCC04) is more susceptible to scratches and scuffs in a workstation environment and requires more care when removing protective packaging. Scratches and scuffs may not be covered under warranty.

Accent color is applied to pull handle stripe, lumbar casing, arm adjustment and caster rings.

FOCUS 2.0



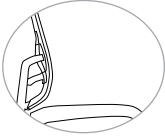

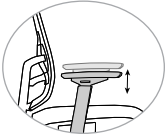
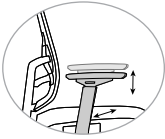
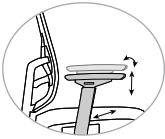
EFFECTIVE OCTOBER 17, 2022 | GSA SIN #: 33721

4. Arms

Arm Style	Code	Price	
Armless	AR0	- \$48	
Fixed Arms	AR2	- \$10	
Height-Adjustable	AR4	+ \$0	
Height-/Width-Adjustable (4-Way)	AR6	+ \$25	
Fully Adjustable (8-Way)	AR9	+ \$60	

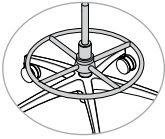
Arms, if specified, come with fog arm pads for the white (FC12) and fog (FC13) frames and black arm pads for the black frame (FC1).

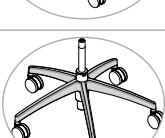
5. Base

Base	Code	Price	
Stool Kit	S1	+ \$0	
Extended Stool Kit	S2	+ \$24	
Base Style	Code	Price	
5-Star Nylon	BT1	+ \$0	
5-Star Polished Aluminum	BT2	+ \$113	
Nylon Base Color	Code	Price	
Black Nylon Base	BC1	+ \$0	
Fog Nylon Base	BC4	+ \$0	
White Nylon Base	BC3	+ \$0	

MESH BACK TASK STOOL

5. Base (Cont.)

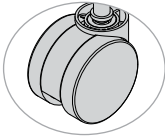
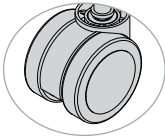
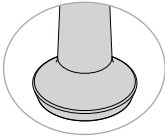
Casters or Glides	Code	Price	
Casters			
Carpet Casters	CS5	+ \$0	
Hard Floor and Carpet Casters	CS6	+ \$40	
Glides			
Glides for Task Chairs	CS3	+ \$30	

6. Material

Mesh	Code	Price	
Focus 2.0 Mesh			
Apple	MC31	+ \$0	
Desert	MC9	+ \$0	
Electric Blue	MC13	+ \$0	
Fire	MC10	+ \$0	
Fog	MC7	+ \$0	
Navy	MC8	+ \$0	
Nickel	MC6	+ \$0	
Ocean	MC29	+ \$0	
Onyx	MC5	+ \$0	
Tangerine	MC28	+ \$0	
Focus 2.0 Uptown Mesh			
Midnight	MC43	+ \$0	
Charcoal	MC44	+ \$0	
Ash	MC45	+ \$0	
Dune	MC46	+ \$0	
Focus Mesh			
Black	MC1	+ \$0	
Sand	MC3	+ \$0	
Slate	MC2	+ \$0	
Freeway Sport Stripe (Black/Slate)	MC33	+ \$0	
Impress Sport Stripe (Slate/Black)	MC34	+ \$0	

Sport striped meshes list the predominant color first.

6. Material (Cont.)

Seat Textile	Code	Price
Fabric/Vinyl Grade 1	FG1/VG1	+ \$0
COM	COM	+ \$26
Fabric/Vinyl Grade 2	FG2/VG2	+ \$26
Fabric/Vinyl Grade 3	FG3/VG3	+ \$60
Fabric/Vinyl Grade 4	FG4/VG4	+ \$116
Fabric/Vinyl Grade 5	FG5/VG5	+ \$172
Fabric/Vinyl Grade 6	FG6/VG6	+ \$213
Fabric/Vinyl Grade 7	FG7/VG7	+ \$254
Leather Grade 1	LG1	+ \$300
COL	COL	+ \$380
Leather Grade 2	LG2	+ \$380
Leather Grade 3	LG3	+ \$480

Please reference the [Textile Reference Guide](#) for pricing on fabric over grade 7 and leather over grade 3.

7. Packaging

Mesh	Code	Price
Knocked Down	KD	+ \$0
Back Attached to Seat, Base Separate	UC	+ \$80
Fully Assembled in a Carton	AC	+ \$200

MESH BACK TASK STOOL

SPECIFICATIONS

	1123 BK1 MB S1 Task Stool	1123 BK1 MB S2 Extended Task Stool
Dimensions		
Overall Width Without Arms	26"	26"
Overall Width With Arms	28.5"	28.5"
Overall Depth	28"	28"
Overall Height	39"-46.5"	42.13"-52"
Seat Width	19.5"	19.5"
Seat Depth	18"	18"
Seat Height	20.5"-28"	23.37"-33.25"
Back Width	18.5"	18.5"
Back Height	19.5"	19.5"
Materials		
COM	1 yd	1 yd
COL	14 sq ft	14 sq ft
Weight and Capacity		
Weight Armless	32.2 lb	33.2 lb
Weight With Arms	37 lb	38 lb
Weight Capacity Warranty	300 lb	300 lb

Swivel-tilt mechanism (T). Enhanced synchro mechanism (Y).

Glove Active

CONFERENCE CHAIR

The lap of luxury.

The Glove™ Active is a luxurious leadership chair that combines pillow-top padding with classic tufted leather seating. It boasts an abundance of foam padding and folds of leather. Available with four mechanism choices, six adjustable arm styles, and optional seat-depth adjustment, Glove Active raises the bar for flexibility and control. It's a luxurious choice for guest and task seating in an executive suite, boardroom or behind a manager's desk.



EFFECTIVE OCTOBER 17, 2022

Featured Models

GOOD :: \$1,710

Midback, swivel-tilt mechanism, loop arms, nylon base, grade 1 leather

BETTER :: \$2,147

Highback, enhanced synchro mechanism, height-adjustable arms, nylon base, grade 2 leather

BEST :: \$2,420

Highback, multi-function mechanism with seat-depth adjustment, height-/width-adjustable arms with pivot, brushed aluminum base, grade 2 leather

GLOVE ACTIVE

EFFECTIVE OCTOBER 17, 2022 | GSA SIN #: 33721

Features

- Pillow top
- Midback or highback
- Waterfall seat
- 250 lb weight capacity warranty;
350 lb Heavy Duty weight capacity warranty

1. Back

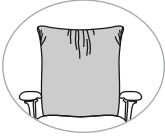
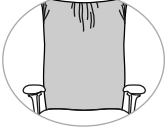
Back Size and Style	Code	Price	
Midback	7531	\$1,575	
Highback	7532	\$1,607	

2. Super Duty

Super Duty Series	Code	Price	
Heavy Duty	HD	+ \$126	

Heavy duty option not available with swivel-tilt (T) mechanism. See the Super Duty Guide on [page 115](#) for additional LT and HD options.

CONFERENCE CHAIR

3. Mechanism

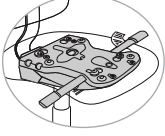
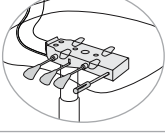
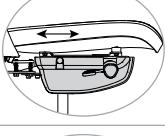
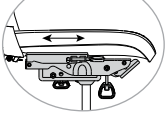
Mechanism Style	Code	Price	
Swivel-Tilt	T	- \$90	
Enhanced Synchro	Y	+ \$0	
Multi-Function	M	+ \$36	
Enhanced Synchro With Seat-Depth Adjustment	Y E3	+ \$79	
Multi-Function With Seat-Depth Adjustment	M E3	+ \$115	





Good

4. Arms

Arm Style	Code	Price	
Armless	A0	- \$90	
Fixed Loop	A26	- \$15	
Height-Adjustable	A27-L	+ \$0	
Height-Adjustable With Pivot	A27	+ \$10	
Height-/Width-Adjustable	A28-L	+ \$25	
Height-/Width-Adjustable With Pivot	A28	+ \$45	

Heavy Duty (HD) option not available with fixed loop arms.

5. Base

Base Color and Material	Code	Price	
Black Nylon Base	B0	+ \$0	
Heavy Duty Black Nylon Base, 26" (For HD)	B7	+ \$0	
Brushed Aluminum Base	B2	+ \$113	

Aluminum base (B2) not available with seat-depth adjustment (E3).

CONFERENCE CHAIR

5. Base (Cont.)

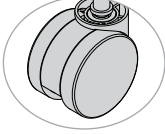
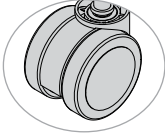
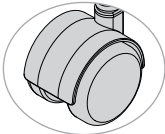
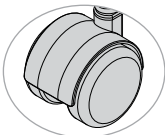
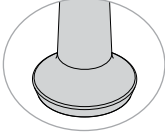
Casters or Glides	Code	Price	
Casters			
Black Carpet Casters	C11	+ \$0	
Black Hard Floor and Carpet Casters	C9	+ \$40	
Self-Locking Carpet Casters	C2	+ \$30	
Self-Locking Hard Floor and Carpet Casters	C7	+ \$61	
Glides			
Glides for Task Chairs	C3	+ \$30	

Self-locking casters (C2/C7) lock only when not in use. Self-locking casters not available for Heavy Duty series.

6. Material

Ballistic Nylon	Code	Price
Ballistic Nylon Back	BN	+ \$0
None	N	+ \$0
Seat and Back Textile	Code	Price
Fabric/Vinyl Grade 1	FG1/VG1	+ \$0
COM	COM	+ \$40
Fabric/Vinyl Grade 2	FG2/VG2	+ \$40
Fabric/Vinyl Grade 3	FG3/VG3	+ \$84
Fabric/Vinyl Grade 4	FG4/VG4	+ \$156
Fabric/Vinyl Grade 5	FG5/VG5	+ \$228
Fabric/Vinyl Grade 6	FG6/VG6	+ \$304
Fabric/Vinyl Grade 7	FG7/VG7	+ \$378
Leather Grade 1	LG1	+ \$240
COL	COL	+ \$540
Leather Grade 2	LG2	+ \$540
Leather Grade 3	LG3	+ \$820
Leather/Ballistic Grade 2	BN2	+ \$379
Leather/Ballistic Grade 3	BN3	+ \$631

Please reference the [Textile Reference Guide](#) for pricing on fabric over grade 7 and leather over grade 3.

Please reference the Fabric information found on [page 17](#) for pricing on multi-upholstery.

Note: Due to the alignment between chair panels, the chairs ordered in a textile will ship with a black spacer mesh outer back. Chairs ordered in vinyl or leather ship fully upholstered in the finish selected.

7. Packaging

Packaging	Code	Price
Back Attached to Seat, Base Separate	UC	+ \$0
Fully Assembled in a Carton	AC	+ \$120

CONFERENCE CHAIR

SPECIFICATIONS

	7531 Midback Chair	7532 Highback Chair
Dimensions		
Overall Width	27.75"	27.75"
Overall Depth	25"	25"
Overall Height	40" (T) 40.5 (Y/M)	43" (T) 43.5 (Y/M)
With Aluminum Base	40.5" (T/B2) 41" (Y/M/B2)	43.5" (T/B2) 44" (Y/M/B2)
Seat Width	19.75"	19.75"
Seat Depth	17"	18"
Seat Height	16.25"-20.75" (T) 16.5"-20" (Y) 16.5"-21" (M)	16.25"-20.75" (T) 16.5"-20" (Y) 16.5"-21" (M)
With Aluminum Base	16.75"-21.25" (T) (B2) 17"-20.5" (Y) (B2) 17"-21.5" (M) (B2)	16.75"-21.25" (T) (B2) 17"-20.5" (Y) (B2) 17"-21.5" (M) (B2)
Back Width	23"	23"
Back Height	19.5"	22.5"
Materials		
COM	2.4 yd 1.25 yd (BN)	2.5 yd 1.4 yd (BN)
COL	50 sq ft 36 sq ft (BN)	55 sq ft 42 sq ft (BN)
Weight and Capacity		
Weight	56 lb (T) 63 lb (Y) 64 lb (M)	59 lb (T) 66 lb (Y) 67 lb (M)
Weight	250 lb	250 lb
Capacity Warranty	350 lb (HD)	350 lb (HD)

Swivel-tilt mechanism (T). Enhanced synchro mechanism (Y). Heavy duty (HD).

Multi-function mechanism (M). Ballistic nylon back (BN). Brushed aluminum base (B2)

Glove Executive

CONFERENCE CHAIR

The lap of luxury.

The Glove™ Executive is a luxurious leadership chair that combines pillow-top padding with classic tufted leather seating. Boasting an abundance of foam padding and folds of leather, Glove is the seat of comfort for the head of a boardroom conference table or the corner office.



Best

EFFECTIVE OCTOBER 17, 2022

Featured Models

GOOD :: \$1,866

Midback, swivel-tilt mechanism, loop arms, nylon base, grade 1 leather

BETTER :: \$1,899

Midback, knee-tilt mechanism, loop arms, nylon base, grade 1 leather

BEST :: \$2,344

Highback, knee-tilt mechanism, loop arms, brushed aluminum base, grade 2 leather

GLOVE EXECUTIVE

EFFECTIVE OCTOBER 17, 2022 | GSA SIN #: 33721

Features

- Pillow top
- Midback or highback
- Optional button detail
- Waterfall seat
- 250 lb weight capacity warranty;
350 lb Heavy Duty weight capacity warranty

1. Back

Back Size and Style	Code	Price	
---------------------	------	-------	--

Midback

7541

\$1,659



Highback

7542

\$1,691

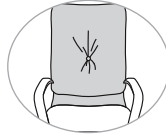

Back Options	Code	Price	
--------------	------	-------	--

Remove Button

RB

+ \$0

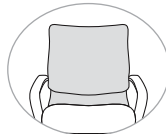

2. Mechanism

Mechanism Style	Code	Price	
-----------------	------	-------	--

Swivel-Tilt

T

- \$33



Knee-Tilt

K

+ \$0



CONFERENCE CHAIR

3. Arms

Arm Style	Code	Price	
-----------	------	-------	--

Fixed Loop

A26

+ \$0



4. Base

Base Color and Material	Code	Price	
-------------------------	------	-------	--

Black Nylon Base

B0

+ \$0



Brushed Aluminum Base

B2

+ \$113



Casters or Glides	Code	Price	
-------------------	------	-------	--

Casters

Carpet Casters

C5

+ \$0

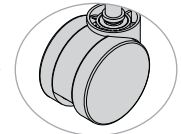

Black Carpet Casters
(For Brushed Aluminum Base B2)

C11

+ \$0

Hard Floor and
Carpet Casters

C1

+ \$40

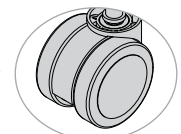

Black Hard Floor
and Carpet Casters
(For Brushed Aluminum Base B2)

C9

+ \$61

Self-Locking Carpet Casters

C2

+ \$30

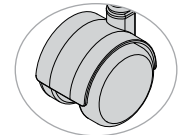

Self-Locking Hard Floor and
Carpet Casters

C7

+ \$61

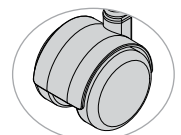

Glides

Glides for Task Chairs

C3

+ \$30

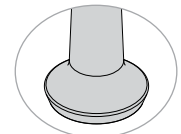

Self-locking casters (C2/C7) lock only when not in use.

GLOVE EXECUTIVE

EFFECTIVE OCTOBER 17, 2022 | GSA SIN #: 33721

5. Material

Ballistic Nylon Back	Code	Price
Ballistic Nylon Back	BN	+ \$0
None	N	+ \$0
Seat and Back Textile	Code	Price
Fabric/Vinyl Grade 1	FG1/VG1	+ \$0
COM	COM	+ \$40
Fabric/Vinyl Grade 2	FG2/VG2	+ \$40
Fabric/Vinyl Grade 3	FG3/VG3	+ \$84
Fabric/Vinyl Grade 4	FG4/VG4	+ \$156
Fabric/Vinyl Grade 5	FG5/VG5	+ \$228
Fabric/Vinyl Grade 6	FG6/VG6	+ \$304
Fabric/Vinyl Grade 7	FG7/VG7	+ \$378
Leather Grade 1	LG1	+ \$240
COL	COL	+ \$540
Leather Grade 2	LG2	+ \$540
Leather Grade 3	LG3	+ \$820
Leather/Ballistic Grade 2	BN2	+ \$379
Leather/Ballistic Grade 3	BN3	+ \$631

Please reference the [Textile Reference Guide](#) for pricing on fabric over grade 7 and leather over grade 3.

Please reference the Fabric information found on [page 17](#) for pricing on multi-upholstery.

Note: Due to the alignment between chair panels, the chairs ordered in a textile will ship with a black spacer mesh outer back. Chairs ordered in vinyl or leather ship fully upholstered in the finish selected.



Good

CONFERENCE CHAIR

6. Packaging

Packaging	Code	Price
Back Attached to Seat, Base Separate	UC	+ \$0

SPECIFICATIONS

	7541 Midback Conference	7542 Highback Conference
Dimensions		
Overall Width	24.5"	24.5"
Overall Depth	27"	27"
Overall Height	42" (B0) 42.5" (B2)	48" (B0) 48.5" (B2)
Seat Width	20.5"	20.5"
Seat Depth	20"	20"
Seat Height With Aluminum Base	16.5"-21" (B0) 17"-21.5" (B2)	16.5"-21" (B0) 17"-21.5" (B2)
Back Width	22.75"	22.75"
Back Height	21"	27"
Materials		
COM	3.25 yd 2.15 yd (BN)	3.5 yd 2.35 yd (BN)
COL	56 sq ft 44 sq ft (BN)	70 sq ft 57 sq ft (BN)
Weight and Capacity		
Weight	61 lb (T) 64 lb (K)	69 lb (T) 72 lb (K)
Weight Capacity	250 lb	250 lb

Swivel-tilt mechanism (T). Knee-tilt mechanism (K). Ballistic nylon back (BN). Black nylon base (B0). Brushed aluminum base (B2)

Hexy

TASK AND CONFERENCE CHAIR

Powered by fusion.

Hexy is what happens when you let inspiration drive innovation—and engineer ergonomics right into the frame. Its hexagon core creates natural support so there's no need for external lumbar controls, and the high-performing mesh fuses with the extra-wide backrest seamlessly. It's the ultimate seat for action-packed (and comfort-backed) environments.



EFFECTIVE OCTOBER 17, 2022

Featured Models

GOOD :: \$554

Midback task chair, black frame, swivel-tilt mechanism, fixed arms, standard cylinder, carpet casters, grade 1 textile

BETTER :: \$610

Highback task chair, black frame, standard synchro mechanism, height-adjustable arms, standard cylinder, carpet casters, grade 1 textile



BEST :: \$754

Highback task chair, white frame, standard synchro mechanism with seat-depth adjustment, height-/width-adjustable (4-way) arms, standard cylinder, carpet casters, grade 1 textile

Features

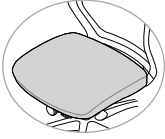

- Extra-wide backrest with innovative hexagon core provides integrated ergonomics
- Ultra-supportive performance mesh seamlessly fuses with a lightweight frame
- Aerodynamic arms and pull handle offer active comfort and convenience
- Multiple mesh, frame, arm and mechanism options let you customize endlessly

1. Back and Seat

Back Size and Style	Code	Price	
Midback Mesh	1203 BK1 MB	\$582	
Highback Mesh	1203 BK2 MB	\$610	
Seat	Code	Price	
Upholstered Seat	US	+ \$0	

TASK AND CONFERENCE CHAIR

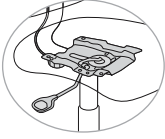

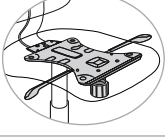
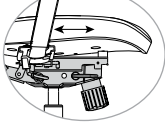
2. Mechanism

Mechanism Style	Code	Price	
Basic	B	- \$33	
Swivel-Tilt	T	- \$18	
Standard Synchro	F	+ \$0	
Standard Synchro With Seat-Depth Adjustment	F/E3	+ \$79	

3. Frame

Frame Color	Code	Price	
Black	FC1	+ \$0	
Fog	FC13	+ \$35	
White	FC12	+ \$35	

4. Arms

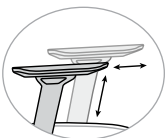
Arm Style	Code	Price	
Armless	AR0	- \$48	
Fixed Arm	AR2	- \$10	
Height-Adjustable	AR4	+ \$0	
Height/Width Adjustable (4-Way)	AR6	+ \$30	

5. Base

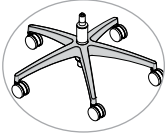
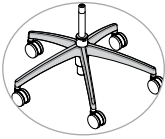
Base Style	Code	Price	
5-Star Nylon	BT1	+ \$0	
5-Star Polished Aluminum	BT2	+ \$113	

Base Color	Code	Price	
Black Nylon Base	BC1	+ \$0	
Fog Nylon Base	BC4	+ \$0	
White Nylon Base	BC3	+ \$0	

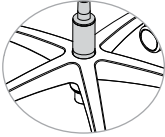
Cylinder Height	Code	Price	
Standard Cylinder	CH1	+ \$0	
Higher Cylinder	CH3	+ \$0	

TASK AND CONFERENCE CHAIR

5. Base Cont.)

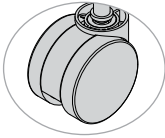
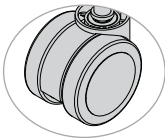
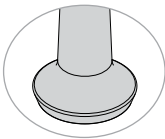
Casters or Glides	Code	Price	
Casters			
Carpet Casters	CS5	+ \$0	
Hard Floor and Carpet Casters	CS6	+ \$40	
Glides			
Glides for Task Chairs	CS3	+ \$30	

The higher cylinder (CH3) is only available with the black base regardless of frame color.

6. Material

Mesh Color	Code	Price	
Apple	MC31	+ \$0	
Desert	MC22	+ \$0	
Electric Blue	MC24	+ \$0	
Fire	MC25	+ \$0	
Fog	MC23	+ \$0	
Navy	MC8	+ \$0	
Nickel	MC21	+ \$0	
Ocean	MC29	+ \$0	
Onyx	MC20	+ \$0	
Tangerine	MC28	+ \$0	

6. Material (Cont.)

Seat Textile	Code	Price
Fabric/Vinyl Grade 1	FG1/VG1	+ \$0
COM	COM	+ \$26
Fabric/Vinyl Grade 2	FG2/VG2	+ \$26
Fabric/Vinyl Grade 3	FG3/VG3	+ \$60
Fabric/Vinyl Grade 4	FG4/VG4	+ \$116
Fabric/Vinyl Grade 5	FG5/VG5	+ \$172
Fabric/Vinyl Grade 6	FG6/VG6	+ \$213
Fabric/Vinyl Grade 7	FG7/VG7	+ \$254
Leather Grade 1	LG1	+ \$300
COL	COL	+ \$380
Leather Grade 2	LG2	+ \$380
Leather Grade 3	LG3	+ \$480

Please reference the [Textile Reference Guide](#) for pricing on fabric over grade 7 and leather over grade 3.

7. Packaging

Packaging	Code	Price
Knocked Down	KD	+ \$0
Back Attached to Seat, Base Separate	UC	+ \$80
Fully Assembled in a Carton	AC	+ \$200

TASK AND CONFERENCE CHAIR

SPECIFICATIONS

	1203 BK1 MB Midback Mesh	1203 BK2 MB Highback Mesh
Dimensions		
Overall Width Without Arms	26.25"	26.25"
Overall Width With Arms	26.25"	26.25"
Overall Depth	27"	27"
Overall Height	36.5"	39.5"
Seat Width	20"	20"
Seat Depth	17"-19"	17"-19"
Seat Height	16"-19.75" (B, CH1) 16.25"-20" (T, CH1) 16.75"-20.25" (F, CH1) 17"-20.625" (F/E3, CH1) 16.25"-21.25" (B, CH3) 16.5"-21.5" (T, CH3) 17"-22" (F, CH3) 17.25"-22.25" (F/E3, CH3)	16"-19.75" (B, CH1) 16.25"-20" (T, CH1) 16.75"-20.25" (F, CH1) 17"-20.625" (F/E3, CH1) 16.25"-21.25" (B, CH3) 16.5"-21.5" (T, CH3) 17"-22" (F, CH3) 17.25"-22.25" (F/E3, CH3)
Back Width	19.25"	19.5"
Back Height	19.25"	22.25"
Materials		
COM	1 yd	1 yd
COL	17 sq ft	17 sq ft
Weight and Capacity		
Weight Armless	32 lb	33 lb
Weight With Arms	38 lb	39 lb
Weight Capacity	300 lb	300 lb

Basic mechanism (B). Swivel-tilt mechanism (T). Standard synchro mechanism (F). Standard synchro mechanism with seat-depth adjustment (F/E3). Standard cylinder (CH1). Higher cylinder (CH3).

Hexy

MESH BACK TASK STOOL

Powered by fusion.

Hexy is what happens when you let inspiration drive innovation—and engineer ergonomics right into the frame. Its hexagon core creates natural support so there's no need for external lumbar controls, and the high-performing mesh fuses with the extra-wide backrest seamlessly. It's the ultimate seat for action-packed (and comfort-backed) environments.



EFFECTIVE OCTOBER 17, 2022

Featured Models

GOOD :: \$649

Midback task stool, basic mechanism, black frame, armless, standard stool kit, nylon base, carpet casters, grade 1 textile

BETTER :: \$694

Midback task stool, basic mechanism, fog frame, height-adjustable arms, standard stool kit, nylon base, carpet casters, grade 1 textile,

BEST :: \$861

Midback task stool, basic mechanism, white frame, height-/width-adjustable (4-way) arms, extended stool kit, polished aluminum base, carpet casters, grade 1 textile,

Features

- Extra-wide backrest with innovative hexagon core provides integrated ergonomics
- Ultra-supportive performance mesh seamlessly fuses with a lightweight frame
- Aerodynamic arms and pull handle offer active comfort and convenience
- Multiple mesh, frame arm and mechanism options let you customize endlessly

1. Back and Seat

Back Size and Style	Code	Price	
Midback Mesh	1203 BK1 MB	\$659	

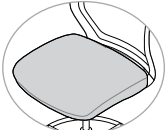
Seat	Code	Price	
Upholstered Seat	US	+\$0	

2. Mechanism



Mechanism Style	Code	Price	
Basic	B	+\$0	

3. Frame

Frame Color	Code	Price	
Black	FC1	+\$0	
Fog	FC13	+\$35	
White	FC12	+\$35	

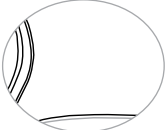

TASK STOOL

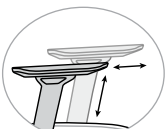
4. Arms

Arm Style	Code	Price	
Armless	AR0	-\$48	
Fixed Arm	AR2	-\$10	
Height-Adjustable	AR4	+\$0	
Height/Width Adjustable (4-Way)	AR6	+\$30	

5. Base

Base	Code	Price	
Stool Kit	S1	+\$0	
Extended Stool Kit	S2	+\$24	

Base Style	Code	Price	
5-Star Nylon	BT1	+\$0	
5-Star Polished Aluminum	BT2	+\$113	

Base Color	Code	Price	
Black Nylon Base	BC1	+\$0	
Fog Nylon Base	BC4	+\$0	
White Nylon Base	BC3	+\$0	

5. Base (Cont.)

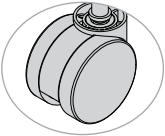
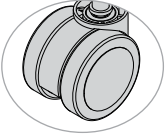
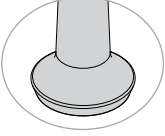
Casters or Glides	Code	Price	
Casters			
Carpet Casters	CS5	+ \$0	
Hard Floor and Carpet Casters	CS6	+ \$40	
Glides			
Glides for Task Chairs	CS3	+ \$30	

The higher cylinder (CH3) is only available with the black base regardless of frame color.

6. Material

Mesh Color	Code	Price	
Apple	MC31	+ \$0	
Desert	MC22	+ \$0	
Electric Blue	MC24	+ \$0	
Fire	MC25	+ \$0	
Fog	MC23	+ \$0	
Navy	MC8	+ \$0	
Nickel	MC21	+ \$0	
Ocean	MC29	+ \$0	
Onyx	MC20	+ \$0	
Tangerine	MC28	+ \$0	

TASK STOOL

6. Material (Cont.)

Seat Textile	Code	Price	
Fabric/Vinyl Grade 1	FG1/VG1	+ \$0	
COM	COM	+ \$26	
Fabric/Vinyl Grade 2	FG2/VG2	+ \$26	
Fabric/Vinyl Grade 3	FG3/VG3	+ \$60	
Fabric/Vinyl Grade 4	FG4/VG4	+ \$116	
Fabric/Vinyl Grade 5	FG5/VG5	+ \$172	
Fabric/Vinyl Grade 6	FG6/VG6	+ \$213	
Fabric/Vinyl Grade 7	FG7/VG7	+ \$254	
Leather Grade 1	LG1	+ \$300	
COL	COL	+ \$380	
Leather Grade 2	LG2	+ \$380	
Leather Grade 3	LG3	+ \$480	

Please reference the [Textile Reference Guide](#) for pricing on fabric over grade 7 and leather over grade 3.

7. Packaging

Packaging	Code	Price	
Knocked Down	KD	+ \$0	
Back Attached to Seat, Base Separate	UC	+ \$80	
Fully Assembled in a Carton	AC	+ \$200	

EFFECTIVE OCTOBER 17, 2022 | GSA SIN #: 33721

SPECIFICATIONS

	1203 BK1 MB S1 Task Stool	1203 BK1 MB S2 Extended Task Stool
Dimensions		
Overall Width Without Arms	26.25"	26.25"
Overall Width With Arms	26.25"	26.25"
Overall Depth	27"	27"
Overall Height	41.875"	44.75"
Seat Width	20"	20"
Seat Depth	17"	17"
Seat Height	21.375"-29"	24.25"-34.25"
Back Width	19.25"	19.25"
Back Height	19.25"	19.25"
Materials		
COM	1 yd	1 yd
COL	17 sq ft	17 sq ft
Weight and Capacity		
Weight Armless	30 lb	31 lb
Weight With Arms	36 lb	37 lb
Weight Capacity	300 lb	300 lb



InFlex

LIGHT TASK CHAIR AND STOOL

Geometry in motion.

The InFlex™ light task chair and stool deliver task functionality with fun styling. Designer Giancarlo Piretti fused design and engineering to create the flexback disc system that follows the spine's natural curve. A stylish, comfortable and affordable standout in a creative office space or anywhere collaboration is called for.



EFFECTIVE OCTOBER 17, 2022

Featured Models

GOOD :: \$501

Task chair, all plastic seat and back, basic mechanism, armless, carpet casters

BETTER :: \$559

Task chair, plastic back, upholstered seat, basic mechanism, armless, carpet casters, grade 1 textile



BEST :: \$675

Task chair, upholstered seat and back, basic mechanism, fixed task arms, carpet casters, grade 1 textile



Features

- Giancarlo Piretti design
- Innovative disc system emulates the human spine
- Fully upholstered, upholstered seat or plastic
- Nine plastic colors
- Two frame finishes
- CAL 133 approved models
- 300 lb weight capacity warranty
- Complements InFlex multipurpose chair, counter and bar stool; see [page 236](#)

1. Back

Back and Seat Style	Code	Price	
Plastic	No Code	\$501	
Upholstered Seat	US	\$559	
Upholstered Seat and Back	UP	\$617	

2. Frame

Frame Type	Code	Price	
Task Chair	973B	+ \$0	
Task Stool	973B S1	+ \$132	
Extended Task Stool	973B S2	+ \$156	



LIGHT TASK CHAIR AND STOOL

2. Frame (Cont.)

Frame Finish	Code	Price	
Black	FC1	+ \$0	
Silver	FC2	+ \$0	

InFlex task models come with basic mechanism (swivel only).

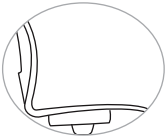
3. Arms

Arm Style	Code	Price	
Armless	A0	+ \$0	
Fixed Task Arms	A122	+ \$58	

4. Base

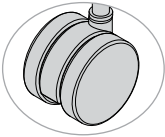
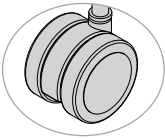
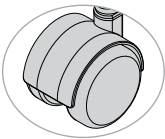
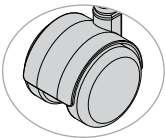
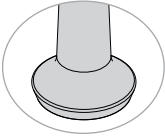
Casters or Glides	Code	Price	
Casters			
Carpet Casters	C15	+ \$0	
Hard Floor and Carpet Casters	C14	+ \$40	
Self-Locking Carpet Casters	C20	+ \$30	
Self-Locking Hard Floor and Carpet Casters	C19	+ \$64	
Glides			
Glides for Task Chairs	C3	+ \$30	

Self-locking casters (C19/C20) lock only when not in use.

5. Material

Protection	Code	Price
Fire Retardancy		
CAL 133, Fabric, Quantities 1–49	133F	+ \$99
CAL 133, Fabric, Quantities 50+	133F5	+ \$55
CAL 133, Plastic, Any Quantity	133P	+ \$45
Shell Color	Code	Price
Arctic	SC21	+ \$0
Black	SC1	+ \$0
Chocolate	SC4	+ \$0
Lagoon	SC15	+ \$0
Latte	SC20	+ \$0
Navy	SC5	+ \$0
Red	SC19	+ \$0
Slate	SC8	+ \$0
Sterling	SC18	+ \$0
Textile	Code	Price
Seat Textile Only (For US)		
Fabric/Vinyl Grade 1	FG1/VG1	+ \$0
COM	COM	+ \$22
Fabric/Vinyl Grade 2	FG2/VG2	+ \$22
Fabric/Vinyl Grade 3	FG3/VG3	+ \$45
Fabric/Vinyl Grade 4	FG4/VG4	+ \$77
Fabric/Vinyl Grade 5	FG5/VG5	+ \$116
Fabric/Vinyl Grade 6	FG6/VG6	+ \$159
Fabric/Vinyl Grade 7	FG7/VG7	+ \$200
Seat and Back Textile (For UP)		
Fabric/Vinyl Grade 1	FG1/VG1	+ \$0
COM	COM	+ \$34
Fabric/Vinyl Grade 2	FG2/VG2	+ \$34
Fabric/Vinyl Grade 3	FG3/VG3	+ \$74
Fabric/Vinyl Grade 4	FG4/VG4	+ \$121
Fabric/Vinyl Grade 5	FG5/VG5	+ \$174
Fabric/Vinyl Grade 6	FG6/VG6	+ \$235
Fabric/Vinyl Grade 7	FG7/VG7	+ \$296

Please reference the [Textile Reference Guide](#) for pricing on fabric over grade 7. Additional CAL 133 information can be found on [page 15](#).

Please reference the [Fabric information](#) found on [page 17](#) for pricing on multi-upholstery.

LIGHT TASK CHAIR AND STOOL

6. Packaging

Packaging	Code	Price
Back Attached to Seat, Base Separate	UC	+ \$0

SPECIFICATIONS

	973B Task Chair	973B S1 Task Stool	973B S2 Extended Task Stool
Dimensions			
Overall Width Armless	19.75"	19.75"	19.75"
Overall Width With Arms	25"	25"	25"
Overall Depth	22.25"	22.25"	22.25"
Overall Height	32.5"	38.5"	42.5"
Seat Width	16.75"	16.75"	16.75"
Seat Depth	18.5"	18.5"	18.5"
Seat Height	16.5"–21.5"	20"–28"	24.5"–34.5"
Back Width	19.75"	19.75"	19.75"
Back Height	15.5"	15.5"	15.5"
Materials			
COM	0.85 yd (US) 1 yd (UP)	0.85 yd (US) 1 yd (UP)	0.85 yd (US) 1 yd (UP)
COL	10 sq ft (US) 15 sq ft (UP)	10 sq ft (US) 15 sq ft (UP)	10 sq ft (US) 15 sq ft (UP)
Weight and Capacity			
Weight Armless	15 lb	16.5 lb	16.5 lb
Weight With Arms	19 lb	20.5 lb	20.5 lb
Weight Capacity Warranty	300 lb	300 lb	300 lb

Upholstered seat only (US). Upholstered seat and back (UP).

Ioniq

COLLABORATIVE CHAIR

Inspire unique.

There's a specialness that flows through Ioniq™. Its form and feeling are fluid—from the way the arms stretch seamlessly out of a sculpted shell to base options that are as varied and versatile as the spaces they occupy. Because when you desire aesthetics that elevate any experience and offer something refreshingly different, there's only one go-to. And that's Ioniq.



EFFECTIVE OCTOBER 17, 2022

Featured Models

GOOD :: \$861

Plastic back, upholstered seat, integrated arms, height-adjustable mechanism with swivel and tilt, 5-star nylon base, carpet casters, grade 1 textile

BETTER :: \$974

Plastic back, upholstered seat, integrated arms, height-adjustable mechanism with swivel and tilt, 5-star polished aluminum, carpet casters, grade 1 textile

Features

- Breathable back with built-in lumbar support
- Minimalist-designed mechanism with streamlined controls
- Edge-to-edge cushion
- Fully integrated armrests
- Single-piece sculpted shell
- 5-star base
- Performance casters
- 300 lb weight capacity warranty
- Complements Ioniq Guest and Ioniq Side; see [page 240](#) and [page 242](#)

1. Frame

Frame Type	Code	Price	
Collaborative Task (5-Star Base)	1152 FT3	\$861	

Seat and Back Style	Code	Price	
Plastic Back With Upholstered Seat Pad	US PB	+ \$0	

Shell Color	Code	Price	
Black	SC1	+ \$0	
White	SC26	+ \$0	

2. Base

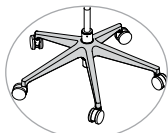
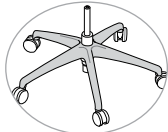
Base Type and Material	Code	Price	
5-Star Nylon	BT1	+ \$0	
5-Star Polished Aluminum	BT2	+ \$113	

COLLABORATIVE CHAIR

2. Base (Cont.)

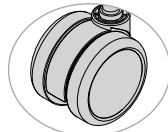
Base Color	Code	Price	
Black Nylon Base	BC1	+ \$0	
White Nylon Base	BC3	+ \$0	
Casters	Code	Price	
Carpet Casters	CS5	+ \$0	
Hard Floor and Carpet Casters	CS6	+ \$40	

Black nylon base (BC1) available with black shell (SC1) only. White nylon base (BC3) available with white shell (SC26) only.

Caster color will correspond to shell color.

3. Mechanism

Mechanism Style	Code	Price	
Height-Adjustable With Swivel and Tilt	T	+ \$0	

4. Material

Seat Textile	Code	Price	
Fabric/Vinyl Grade 1	FG1/VG1	+ \$0	
COM	COM	+ \$22	
Fabric/Vinyl Grade 2	FG2/VG2	+ \$22	
Fabric/Vinyl Grade 3	FG3/VG3	+ \$45	
Fabric/Vinyl Grade 4	FG4/VG4	+ \$77	
Fabric/Vinyl Grade 5	FG5/VG5	+ \$116	
Fabric/Vinyl Grade 6	FG6/VG6	+ \$159	
Fabric/Vinyl Grade 7	FG7/VG7	+ \$200	
Leather Grade 1	LG1	+ \$140	
COL	COL	+ \$200	
Leather Grade 2	LG2	+ \$200	
Leather Grade 3	LG3	+ \$280	

Please reference the [Textile Reference Guide](#) for pricing on fabric over grade 7 and leather over grade 3.

EFFECTIVE OCTOBER 17, 2022 | GSA SIN #: 33721

5. Packaging

Packaging	Code	Price
Back Attached to Seat, Base Separate	UC	+ \$0
Fully Assembled in a Carton	AC	+ \$120

SPECIFICATIONS

	1152 FT3 Collaborative Chair
Dimensions	
Overall Width	28"
Overall Depth	28"
Overall Height	33.75"-37.5"
Seat Width	17.5"
Seat Depth	17.38"
Seat Height	17.5"-21.25"
Back Width	18"
Back Height	17.38"
Materials	
COM	0.75 yd
COL	7 sq ft
Weight and Capacity	
Weight	18.5 lb
Weight Capacity Warranty	300 lb

Chair is widest at the base.



Knack

UPHOLSTERED BACK TASK CHAIR

Smart choice. Everyday.

Knack™ boasts an uncluttered and traditional design that makes it an essential and affordable choice for corporate, healthcare, government and educational settings. The soft, comfortable back follows the natural curve of the spine, providing great support for hours of sitting. Five control selections and a Heavy Duty 24/7 option make Knack a great all-around task chair. Knack includes a back-height adjustment so every user can enjoy individualized upper-back and lumbar support.



EFFECTIVE OCTOBER 17, 2022

Featured Models

GOOD :: \$832

Swivel-tilt mechanism, height-adjustable arms, nylon base, grade 1 textile

BETTER :: \$922

Enhanced synchro mechanism, height-adjustable arms, nylon base, grade 1 textile

BEST :: \$1,026

Enhanced synchro mechanism with seat-depth adjustment, height-/width-adjustable arms, nylon base, grade 1 textile

Features

- Durable and ergonomic
- Internal back-height adjustment (on Y and M mechanisms only)
- Ballistic nylon back (optional)
- Brushed aluminum, polished aluminum or nylon base
- Waterfall seat
- 300 lb weight capacity warranty;
350 lb Heavy Duty weight capacity warranty

1. Back

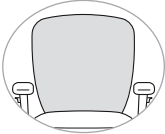

Back Size and Style	Code	Price	
Midback Task Chair	3323	\$922	

2. Super Duty

Super Duty Series	Code	Price	
Heavy Duty	HD	+ \$126	

Must select multi-function (M) or enhanced synchro (Y) mechanism. Not available with fixed loop (A77) arm. See the Super Duty Guide on [page 115](#) for additional LT and HD options.

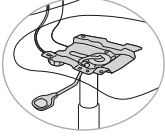
3. Mechanism

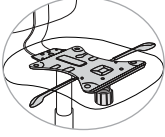
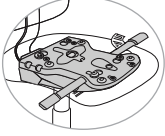
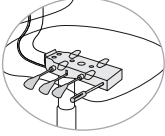
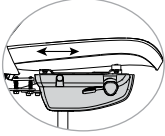
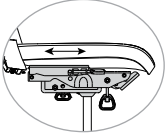
Mechanism Style	Code	Price	
Basic (Swivel Only)	B	- \$127	
Swivel-Tilt	T	- \$90	
Standard Synchro	F	- \$57	
Enhanced Synchro	Y	+ \$0	
Multi-Function	M	+ \$36	
Enhanced Synchro With Seat-Depth Adjustment	Y E3	+ \$79	
Multi-Function With Seat-Depth Adjustment	M E3	+ \$115	

4. Arms



Arm Style	Code	Price	
Armless	A0	- \$90	
Fixed Loop	A77	- \$15	
Height-Adjustable	A80	+ \$0	
Height-/Width-Adjustable	A81	+ \$25	

5. Base

Base Color and Material	Code	Price	
Black Nylon Base	B0	+ \$0	
Black Nylon Base, 26"	B7	+ \$0	
Brushed Aluminum Base	B2	+ \$113	
Polished Aluminum Base	B5	+ \$167	

UPHOLSTERED BACK TASK CHAIR

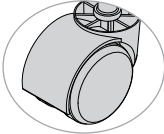
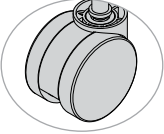
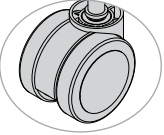
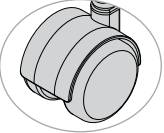
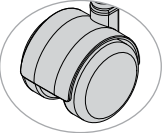
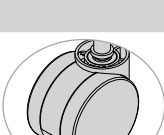
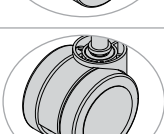
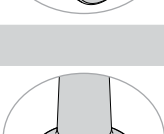
5. Base (Cont.)

Casters or Glides	Code	Price	
Casters			
Carpet Casters	C5	+ \$0	
Hard Floor and Carpet Casters	C1	+ \$40	
Heavy Duty Carpet Casters	C11	+ \$30	
Heavy Duty Hard Floor and Carpet Casters	C9	+ \$61	
Self-Locking Carpet Casters	C2	+ \$30	
Self-Locking Hard Floor and Carpet Casters	C7	+ \$61	
Heavy Duty Casters (For HD Models)			
Heavy Duty Carpet Casters	C11	+ \$0	
Heavy Duty Hard Floor and Carpet Casters	C9	+ \$61	
Glides			
Glides for Task Chairs	C3	+ \$30	

Black nylon base (B0) and polished aluminum base (B5) are not available for Heavy Duty (HD) option.

Self-locking casters (C2/C7) lock only when not in use.

6. Material

Protection	Code	Price
Fire Retardancy		
CAL 133, Fabric, Quantities 1-49	133F	+ \$99
CAL 133, Fabric, Quantities 50+	133F5	+ \$55
CAL 133, Leather, Any Quantity	133L	+ \$119
Ballistic Nylon Back	Code	Price
Ballistic Nylon Back	BN	+ \$0
Seat and Back Textile	Code	Price
Fabric/Vinyl Grade 1	FG1/VG1	+ \$0
COM	COM	+ \$34
Fabric/Vinyl Grade 2	FG2/VG2	+ \$34
Fabric/Vinyl Grade 3	FG3/VG3	+ \$74
Fabric/Vinyl Grade 4	FG4/VG4	+ \$121
Fabric/Vinyl Grade 5	FG5/VG5	+ \$174
Fabric/Vinyl Grade 6	FG6/VG6	+ \$235
Fabric/Vinyl Grade 7	FG7/VG7	+ \$296
Leather Grade 1	LG1	+ \$260
COL	COL	+ \$320
Leather Grade 2	LG2	+ \$320
Leather Grade 3	LG3	+ \$400

Please reference the [Textile Reference Guide](#) for pricing on fabric over grade 7 and leather over grade 3. Additional CAL 133 information can be found on [page 15](#).

Please reference the [Fabric information](#) found on [page 17](#) for pricing on multi-upholstery.

7. Packaging

Packaging	Code	Price
Knocked Down	KD	+ \$0
Back Attached to Seat, Base Separate	UC	+ \$80
Fully Assembled in a Carton	AC	+ \$200

UPHOLSTERED BACK TASK CHAIR

SPECIFICATIONS

	3323 Midback Task Chair
Dimensions	
Overall Width	26"
Overall Depth	26"
Overall Height	34.5" (T/F) 35.5" (Y/M)
With Aluminum Base	35" (T/F) (B2) 36" (Y/M) (B2)
Seat Width	20.5"
Seat Depth	18"
Seat Height	16.5"-21" (T/F/M) 17.5"-22" (Y) 17"-21.5" (T/F/M) (B2/B5) 18"-22.5" (Y) (B2/B5)
Back Width	20"
Back Height	19.5"
Materials	
COM	1.85 yd 1.55 yd (BN)
COL	32 sq ft 27 sq ft (BN)
Weight and Capacity	
Weight Armless	39 lb
Weight With Arms	45 lb
Weight Capacity Warranty	300 lb 350 lb (M/Y)(HD)

Swivel-tilt mechanism (T). Standard synchro mechanism (F). Enhanced synchro mechanism (Y). Multi-function mechanism (M). Brushed aluminum base (B2). Polished aluminum base (B5).

Knack

UPHOLSTERED BACK TASK STOOL

Smart choice. Everyday.

Knack™ boasts an uncluttered and traditional design that makes it an essential and affordable choice for corporate, healthcare, government and educational settings. The soft, comfortable back follows the natural curve of the spine, providing great support for hours of sitting. The Knack stool comes with three arm options and choice of standard black or polished aluminum base.



EFFECTIVE OCTOBER 17, 2022

Featured Models

GOOD :: \$881

Midback stool, basic mechanism, armless, standard stool kit, black nylon base, carpet casters, grade 1 textile

BETTER :: \$971

Midback stool, basic mechanism, height-adjustable arms, standard stool kit, black nylon base, carpet casters, grade 1 textile

BEST :: \$1,020

Midback stool, basic mechanism, height-/width-adjustable arms, extended stool kit, black nylon base, carpet casters, grade 1 textile



Features

- Durable and ergonomic
- Ballistic nylon back (optional)
- Black nylon or polished aluminum base
- Waterfall seat
- 300 lb weight capacity

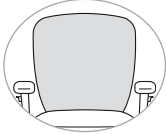
1. Back

Back Size and Style	Code	Price	
Midback Task Stool With Basic Mechanism (Swivel Only)	3323B	\$971	

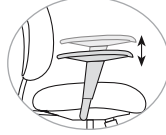
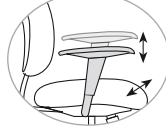

2. Arms

Arm Style	Code	Price	
Armless	A0	- \$90	
Fixed Loop	A77	- \$15	
Height-Adjustable	A80	+ \$0	
Height-/Width-Adjustable	A81	+ \$25	

UPHOLSTERED BACK TASK STOOL

3. Base

Base	Code	Price	
Stool Kit	S1	+ \$0	
Extended Stool Kit	S2	+ \$24	

Base Color and Material	Code	Price	
Black Nylon Base	B0	+ \$0	
Polished Aluminum Base	B5	+ \$167	

Casters or Glides	Code	Price	
Carpet Casters	C5	+ \$0	
Hard Floor and Carpet Casters	C1	+ \$40	

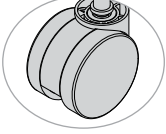
Heavy Duty Carpet Casters	C11	+ \$30	
---------------------------	-----	--------	---

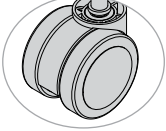
Heavy Duty Hard Floor and Carpet Casters	C9	+ \$61	
--	----	--------	---

Self-Locking Carpet Casters	C2	+ \$30	
-----------------------------	----	--------	---

Self-Locking Hard Floor and Carpet Casters	C7	+ \$61	
--	----	--------	---

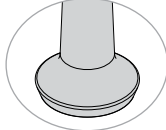
Glides			
Glides for Task Chairs	C3	+ \$30	

Self-locking casters (C2/C7) lock only when not in use.

UPHOLSTERED BACK TASK STOOL

4. Material

Protection	Code	Price
Fire Retardancy		
CAL 133, Fabric, Quantities 1–49	133F	+ \$99
CAL 133, Fabric, Quantities 50+	133F5	+ \$55
CAL 133, Leather, Any Quantity	133L	+ \$119
Ballistic Nylon Back	Code	Price
Ballistic Nylon Back	BN	+ \$0
Seat and Back Textile	Code	Price
Fabric/Vinyl Grade 1	FG1/VG1	+ \$0
COM	COM	+ \$34
Fabric/Vinyl Grade 2	FG2/VG2	+ \$34
Fabric/Vinyl Grade 3	FG3/VG3	+ \$74
Fabric/Vinyl Grade 4	FG4/VG4	+ \$121
Fabric/Vinyl Grade 5	FG5/VG5	+ \$174
Fabric/Vinyl Grade 6	FG6/VG6	+ \$235
Fabric/Vinyl Grade 7	FG7/VG7	+ \$296
Leather Grade 1	LG1	+ \$260
COL	COL	+ \$320
Leather Grade 2	LG2	+ \$320
Leather Grade 3	LG3	+ \$400

Please reference the [Textile Reference Guide](#) for pricing on fabric over grade 7 and leather over grade 3. Additional CAL 133 information can be found on [page 15](#).

Please reference the [Fabric information](#) found on [page 17](#) for pricing on multi-upholstery.

5. Packaging

Packaging	Code	Price
Knocked Down	KD	+ \$0
Back Attached to Seat, Base Separate	UC	+ \$80
Fully Assembled in a Carton	AC	+ \$200

SPECIFICATIONS

	3323 S1 Midback Task Stool	3323 S2 Extended Midback Task Stool
Dimensions		
Overall Width	27"	27"
Overall Depth	26.5"	26.5"
Overall Height With Aluminum Base	44" 44.5" (B5)	44" 44.5" (B5)
Seat Width	21.5"	21.5"
Seat Depth	18"	18"
Seat Height With Aluminum Base	19.5"–27.5" 20"–28" (B2)	23.5"–33.5" 24"–34" (B2)
Back Width	20.5"	20.5"
Back Height	19.5"	19.5"
Materials		
COM	1.85 yd 1.55 yd (BN)	1.85 yd 1.55 yd (BN)
COL	32 sq ft 27 sq ft (BN)	32 sq ft 27 sq ft (BN)
Weight and Capacity		
Weight Armless	53 lb	59 lb
Weight With Arms	67 lb	73 lb
Weight Capacity Warranty	300 lb	300 lb

Ballistic nylon back (BN). Polished aluminum base (B2).

Lumin

LIGHT TASK CHAIR AND STOOL

Light up the room.

Lumin™ is an elegant chair designed for exceptional support and comfort in corporate and education applications. The contoured seat dissipates pressure points for greater comfort while the perforated back adds contemporary style and comfortable breathability. The Lumin light task chair and light task stool are available in black or silver frame finish with matching arm pad colors. Refined, sophisticated Lumin will light up the room.



Better

EFFECTIVE OCTOBER 17, 2022

Featured Models

GOOD :: \$469

Task chair, all plastic seat and back, basic mechanism, armless, black frame, carpet casters

BETTER :: \$620

Task chair, plastic back, upholstered seat, basic mechanism, fixed arms, silver frame, carpet casters, grade 1 textile

BEST :: \$643

Task chair, upholstered seat and back, basic mechanism, fixed arms, black frame, carpet casters, grade 1 textile

Features

- Contemporary design
- Exceptional support and comfort
- Fully upholstered, upholstered seat or plastic
- 14 plastic shell colors
- Two frame finishes with matching arm pads
- Built-in pull handle
- Cleanout space
- 300 lb weight capacity warranty
- Complements Lumin multipurpose chair, counter and bar stool; see [page 246](#)



LIGHT TASK CHAIR AND STOOL

1. Back



Back and Seat Style	Code	Price	
Plastic Seat	PS	\$469	
Upholstered Seat Only	US	\$527	
Upholstered Seat and Back	UP	\$585	

2. Frame

Frame Type	Code	Price	
Task	1012 FT3	+ \$0	
Task Stool	1012 FT3 S21	+ \$132	
Extended Task Stool	1012 FT3 S22	+ \$156	
Frame Finish	Code	Price	
Black	FC1	+ \$0	
Silver	FC2	+ \$35	

Lumin task comes with basic mechanism (swivel only).

3. Arms

Arm Style	Code	Price	
Armless	A0	+ \$0	
Fixed	A147	+ \$58	

4. Base

Base Color and Material	Code	Price	
Black Nylon Base (For Black Frame FC1)	B17	+ \$0	
Fog Nylon Base (For Silver Frame FC2)	B21	+ \$0	

Casters or Glides	Code	Price	
Casters			

Carpet Casters	C15	+ \$0	
----------------	-----	-------	---

Hard Floor and Carpet Casters	C14	+ \$40	
-------------------------------	-----	--------	---

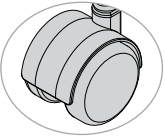
Self-Locking Carpet Casters	C20	+ \$30	
-----------------------------	-----	--------	---

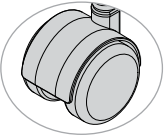
Self-Locking Hard Floor and Carpet Casters	C19	+ \$64	
--	-----	--------	---

Glides

Glides for Task Chairs	C3	+ \$30	
------------------------	----	--------	---

Self-locking casters (C19/C20) lock only when not in use.

LIGHT TASK CHAIR AND STOOL

5. Material

Protection	Code	Price	
Fire Retardancy			
CAL 133, Fabric, Quantities 1–49	133F	+ \$64	
CAL 133, Fabric, Quantities 50+	133F5	+ \$20	
CAL 133, Plastic, Any Quantity	133P	+ \$10	

Shell Color	Code	Price	
Apple	SC24	+ \$0	
Arctic	SC21	+ \$0	
Bisque	SC7	+ \$0	
Black	SC1	+ \$0	
Chocolate	SC4	+ \$0	
Lagoon	SC15	+ \$0	
Latte	SC20	+ \$0	
Lemon	SC25	+ \$0	
Navy	SC5	+ \$0	
Pacific	SC22	+ \$0	
Red	SC19	+ \$0	
Slate	SC8	+ \$0	
Sterling	SC18	+ \$0	
Tangerine	SC23	+ \$0	

Textile	Code	Price	
Seat Textile Only (For US)			
Fabric/Vinyl Grade 1	FG1/VG1	+ \$0	
COM	COM	+ \$22	
Fabric/Vinyl Grade 2	FG2/VG2	+ \$22	
Fabric/Vinyl Grade 3	FG3/VG3	+ \$45	
Fabric/Vinyl Grade 4	FG4/VG4	+ \$77	
Fabric/Vinyl Grade 5	FG5/VG5	+ \$116	
Fabric/Vinyl Grade 6	FG6/VG6	+ \$159	
Fabric/Vinyl Grade 7	FG7/VG7	+ \$200	

5. Material (Cont.)

Textile	Code	Price
Seat and Back Textile (For UP)		
Fabric Grade 1	FG1/VG1	+ \$0
COM	COM	+ \$34
Fabric/Vinyl Grade 2	FG2/VG2	+ \$34
Fabric/Vinyl Grade 3	FG3/VG3	+ \$74
Fabric/Vinyl Grade 4	FG4/VG4	+ \$121
Fabric/Vinyl Grade 5	FG5/VG5	+ \$174
Fabric/Vinyl Grade 6	FG6/VG6	+ \$235
Fabric/Vinyl Grade 7	FG7/VG7	+ \$296

Please reference the [Textile Reference Guide](#) for pricing on fabric over grade 7. Additional CAL 133 information can be found on [page 15](#).

Please reference the [Fabric information](#) found on [page 17](#) for pricing on multi-upholstery.



Best

LIGHT TASK CHAIR AND STOOL

6. Packaging

Packaging	Code	Price
Back Attached to Seat, Base Separate	UC	+ \$0
Fully Assembled In a Carton	AC	+ \$120

SPECIFICATIONS

	1012 FT3 Task Chair	1012 FT3 S21 Task Stool	1012 FT3 S22 Extended Task Stool
Dimensions			
Overall Width	26.8"	26.8"	26.8"
Overall Width With Arms	26.8"	26.8"	26.8"
Overall Depth	26.8"	26.8"	26.8"
Overall Height	31.7"-36.7"	37.7"-45.7"	41.7"-51.7"
Seat Width	19"	19"	19"
Seat Depth	18.7"	18.7"	18.7"
Seat Height	16.62"-21.75"	18"-26"	23"-33"
Back Width	18.3"	18.3"	18.3"
Back Height	16.7"	16.7"	16.7"
Materials			
Weight Armless	20.5"	25.1"	26"
Weight With Arms	22.2"	26.8"	27.7"
COM	0.85 yd (US) 1 yd (UP)	0.85 yd (US) 1 yd (UP)	0.85 yd (US) 1 yd (UP)
COL	10 sq ft (US) 15 sq ft (UP)	10 sq ft (US) 15 sq ft (UP)	10 sq ft (US) 15 sq ft (UP)
Weight and Capacity			
Weight Armless	20.5"	25.1"	26"
Weight With Arms	22.2"	26.8"	27.7"
Weight Capacity Warranty	300 lb	300 lb	300 lb

Upholstered seat only (US). Upholstered seat and back (UP).

Mavic

COLLABORATIVE CHAIR

Cross over collaboration.

Mavic™ is here to prove that a jack-of-all-trades can be a master of all. Looks, features, function, comfort and more—there's so much Mavic offers in a single, light-scale seat that it crosses over into new territory. So when it's time to enable collaboration (wherever and whenever you need it), Mavic sits ready to provide a radical new way to work.



EFFECTIVE OCTOBER 17, 2022

Featured Models

GOOD :: \$862

Floating mesh back with integrated arms, swivel-tilt mechanism, black frame and black nylon base, caster ring accent color, carpet casters, grade 1 textile

BETTER :: \$944

Floating mesh back with integrated arms, weight-activated mechanism with override, tilt limiter and seat slider, white frame and white nylon base, caster ring accent color, carpet casters, grade 1 textile

Features

- Designed by Martin Ballendat
- Slim, single-piece frame design
- Swivel-tilt or weight-activated mechanism
- Eight-hour endurance cushion with 15,000+ textile options
- Built-in lumbar support from tension mesh
- Tapered seat pan with almost-invisible controls
- Advanced adjustments include seat slider and tilt limiter/override
- Performance caster colors coordinate with the frame and base
- Three frame and base, 10 mesh and 12 accent color options
- 300 lb weight capacity warranty

1. Back

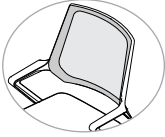
Back Size and Style	Code	Price	
Midback Mesh	1113 MB	\$862	

2. Mechanism

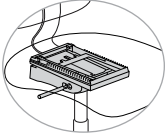
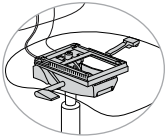
Mechanism	Code	Price	
Swivel-Tilt	T	+ \$0	
Weight-Activated With Override, Tilt Limiter and Seat Slider	WA	+ \$47	

COLLABORATIVE CHAIR

3. Frame

Frame Color	Code	Price	
Black	FC1	+ \$0	
Fog	FC13	+ \$35	
White	FC12	+ \$35	

4. Base

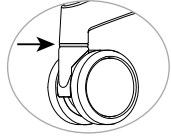
Accent Color	Code	Price	
Apple	LA12	+ \$0	
Desert	LA3	+ \$0	
Electric Blue	LA5	+ \$0	
Fire	LA6	+ \$0	
Fog	LA4	+ \$0	
Graphite	LA14	+ \$0	
Navy	LA15	+ \$0	
Nickel	LA2	+ \$0	
Ocean	LA10	+ \$0	
Onyx	LA1	+ \$0	
Tangerine	LA9	+ \$0	
White	LA13	+ \$0	

Base Style	Code	Price	
5-Star Nylon	BT1	+ \$0	

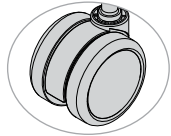
Base Color	Code	Price	
Black Nylon Base	BC1	+ \$0	
Fog Nylon Base	BC4	+ \$0	
White Nylon Base	BC3	+ \$0	

Casters or Glides	Code	Price	
-------------------	------	-------	--

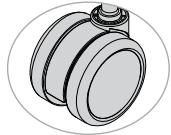
Casters			
Carpet Casters	CS5	+ \$0	
Hard Floor and Carpet Casters	CS6	+ \$40	

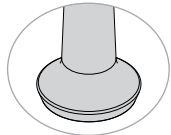
Glides			
Glides for Task Chairs	CS3	+ \$30	

4. Base (Cont.)

Cylinder Height	Code	Price
Standard Cylinder	CH1	+ \$0

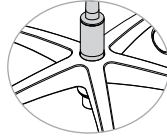

Accent color will apply to caster rings.

Frame, base and caster color will correspond when the nylon base (BT1) is selected.

5. Material

Protection	Code	Price
Fire Retardancy		
CAL 133, Fabric, Quantities 1-49	133F	+ \$99
CAL 133, Fabric, Quantities 50+	133F5	+ \$55
CAL 133, Leather, Any Quantity	133L	+ \$119
Mesh Color	Code	Price
Apple	MC31	+ \$0
Desert	MC9	+ \$0
Electric Blue	MC13	+ \$0
Fire	MC10	+ \$0
Fog	MC7	+ \$0
Navy	MC8	+ \$0
Nickel	MC6	+ \$0
Ocean	MC29	+ \$0
Onyx	MC5	+ \$0
Tangerine	MC28	+ \$0
Seat Textile	Code	Price
Fabric/Vinyl Grade 1	FG1/VG1	+ \$0
COM	COM	+ \$26
Fabric/Vinyl Grade 2	FG2/VG2	+ \$26
Fabric/Vinyl Grade 3	FG3/VG3	+ \$60
Fabric/Vinyl Grade 4	FG4/VG4	+ \$116
Fabric/Vinyl Grade 5	FG5/VG5	+ \$172
Fabric/Vinyl Grade 6	FG6/VG6	+ \$213
Fabric/Vinyl Grade 7	FG7/VG7	+ \$254
Leather Grade 1	LG1	+ \$300
COL	COL	+ \$380
Leather Grade 2	LG2	+ \$380
Leather Grade 3	LG3	+ \$480

Please reference the [Textile Reference Guide](#) for pricing on fabric over grade 7 and leather over grade 3. Additional CAL 133 information can be found on [page 15](#).

COLLABORATIVE CHAIR

6. Packaging

Packaging	Code	Price
Back Attached to Seat, Base Separate	UC	+ \$0
Fully Assembled in a Carton	AC	+ \$120

SPECIFICATIONS

	1113 MB
Dimensions	
Overall Width With Arms	23.5"
Overall Depth	23.5"
Overall Height	35.4"
Seat Width	19"
Seat Depth	17.5"
Seat Height	17.5"-21.5"
Back Width	20"
Back Height	20"
Materials	
COM	0.8 yd
COL	14 sq ft
Weight and Capacity	
Weight With Arms	24.5 lb
Weight Capacity Capacity	300 lb

Movi

LIGHT TASK CHAIR AND STOOL

Movement-inspired. Collaboration-friendly.

For all those quick touch bases that end up being anything but, there's the Movi™ light task chair—an agile task chair that can adapt quickly to a constantly changing environment. Whether you need to quickly set up (or clean up), we've got a chair that can keep up.



EFFECTIVE OCTOBER 17, 2022

Featured Models

GOOD :: \$797

Task chair, mesh back, upholstered seat, basic mechanism, armless, black frame, carpet casters, grade 1 textile

BETTER :: \$827

Task chair, mesh back, upholstered seat, basic mechanism, fixed arms, black frame, carpet casters, grade 1 textile



BEST :: \$862

Task chair, mesh back, upholstered seat, basic mechanism, fixed arms, white frame, carpet casters, grade 1 textile

Features

- Flexes at the hip 14 degrees for enhanced comfort
- Movement-friendly back and arm support
- Clean-out space for easy maintenance
- Bleach-cleanable mesh back
- 12 mesh colors
- Three base frame and caster colors
- Three back frame and arm colors
- Available as an armless option
- Carpet, hard floor and carpet casters available
- 300 lb weight capacity warranty
- Complements Movi nester; see [page 255](#)

1. Frame



Frame Type	Code	Price	
Task	1062 FT3 MB	\$827	
Task Stool	1062 FT3 S21 MB	\$933	
Extended Task Stool	1062 FT3 S22 MB	\$957	

Back Frame Finish	Code	Price	
Black	SC1	+ \$0	
Fog	SC27	+ \$35	
White	SC26	+ \$35	

Movi task models come with basic mechanism (swivel only).

LIGHT TASK CHAIR AND STOOL

2. Arms

Arm Style	Code	Price	
Armless	AR0	-\$30	
Fixed Loop Arms	AR1	+ \$0	

Arms (AR1) will match frame color.

3. Base

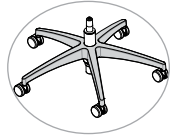
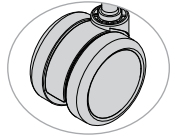
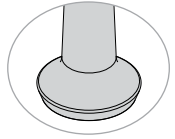
Base Color and Material	Code	Price	
Black Nylon Base With Black Casters	B17	+ \$0	
Fog Nylon Base With Fog Casters	B21	+ \$0	
White Nylon Base With Fog/White Casters	B20	+ \$0	
Casters or Glides	Code	Price	
Casters			
Carpet Casters	CS5	+ \$0	
Hard Floor and Carpet Casters	CS6	+ \$40	
Glides			
Bell Glides	CS20	+ \$30	

4. Material

Protection	Code	Price
Fire Retardancy		
CAL 133, Fabric, Quantities 1-49	133F	+ \$99
CAL 133, Fabric, Quantities 50+	133F5	+ \$55
Mesh Color	Code	Price
Apple	MC31	+ \$0
Aqua	MC30	+ \$0
Desert	MC22	+ \$0
Electric Blue	MC24	+ \$0
Fire	MC25	+ \$0
Fog	MC23	+ \$0
Grape	MC26	+ \$0
Lemon	MC27	+ \$0
Nickel	MC21	+ \$0
Ocean	MC29	+ \$0
Onyx	MC20	+ \$0
Tangerine	MC28	+ \$0
Seat Textile	Code	Price
Fabric/Vinyl Grade 1	FG1/VG1	+ \$0
COM	COM	+ \$22
Fabric/Vinyl Grade 2	FG2/VG2	+ \$22
Fabric/Vinyl Grade 3	FG3/VG3	+ \$45
Fabric/Vinyl Grade 4	FG4/VG4	+ \$77
Fabric/Vinyl Grade 5	FG5/VG5	+ \$116
Fabric/Vinyl Grade 6	FG6/VG6	+ \$159
Fabric/Vinyl Grade 7	FG7/VG7	+ \$200

Please reference the [Textile Reference Guide](#) for pricing on fabric over grade 7. Additional CAL 133 information can be found on [page 15](#).

5. Packaging

Packaging	Code	Price
Back Attached to Seat, Base Separate	UC	+ \$0
Fully Assembled In a Carton	AC	+ \$120

LIGHT TASK CHAIR AND STOOL

SPECIFICATIONS

	1062 FT3 Task Chair	1062 S21 Task Stool	1062 S22 Extended Task Stool
Dimensions			
Overall Width	26"	26"	26"
Overall Depth	26"	26"	26"
Overall Height	34.5"	37.75"	41"
Seat Width	19"	19"	19"
Seat Depth	17"	17"	17"
Seat Height	17.5"-22.5"	21.5"-28.5"	24.5"-34"
Back Width	18"	18"	18"
Back Height	18"	18"	18"
Materials			
COM	1.5 yd	1.5 yd	1.5 yd
COL	10 sq ft	10 sq ft	10 sq ft
Weight and Capacity			
Weight Armless	22 lb	27 lb	28 lb
Weight With Arms	23 lb	28 lb	29 lb
Weight Capacity Warranty	300 lb	300 lb	300 lb



Non-Stop Heavy Duty XL

TASK CHAIR

Around-the-clock comfort.

Designed for durability and backed by solid steel, Non-Stop™ differs from the typical chair construction in that all its mounting points are reinforced with heavy-gauge steel mounting brackets. These solid steel fasteners are second to none for reliability and ergonomic comfort in high-intensity environments where chairs perform all day, every day and support a wide range of users. This heavy duty chair is rated to accommodate users up to 500 pounds and easily handles the demands of 24-hour environments.



Best

EFFECTIVE OCTOBER 17, 2022

Featured Models

GOOD :: \$2,401

Task size 3, dual torsion mechanism, armless, black aluminum base, carpet casters, grade 1 textile

BETTER :: \$2,561

Task size 3, dual torsion mechanism, large loop arms, black aluminum base, carpet casters, grade 1 textile

BEST :: \$2,728

Task size 3, dual torsion mechanism, large loop arms, polished aluminum base, carpet casters, grade 1 textile

NON-STOP

EFFECTIVE OCTOBER 17, 2022 | GSA SIN #: 33721

Features

- Reinforced heavy gauge steel mounting brackets
- Resilient multilayer cushioning
- Waterfall seat promotes proper leg circulation
- Heavy-duty 24/7 option warranted to 500 lb weight capacity

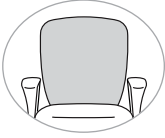

1. Back

Back Size and Style	Code	Price	
Extra Large, 500 lb Capacity	673	\$2,561	

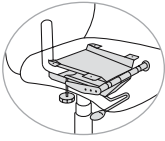
2. Mechanism

Mechanism Style	Code	Price	
Dual Torsion	DT	+ \$0	

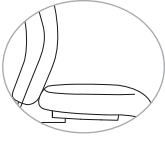
3. Arms

Arm Style	Code	Price	
Armless	A0	- \$160	
Large Loop	A72	+ \$0	

4. Base

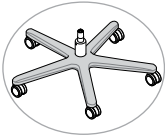
Base Color and Material	Code	Price	
Black Aluminum Base	B0	+ \$0	
Polished Aluminum Base	B5	+ \$167	

HEAVY DUTY TASK CHAIR

4. Base (Cont.)

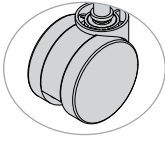
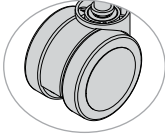
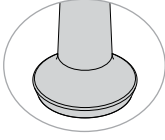
Casters or Glides	Code	Price	
Casters			
Heavy Duty Carpet Casters	C11	+ \$0	
Heavy Duty Hard Floor and Carpet Casters	C9	+ \$61	
Glides			
Glides for Task Chairs	C3	+ \$30	

5. Material

Protection	Code	Price	
Fire Retardancy			
CAL 133, Fabric, Quantities 1-49	133F	+ \$99	
CAL 133, Fabric, Quantities 50+	133F5	+ \$55	
Ballistic Nylon			
Ballistic Nylon Back	BN	+ \$0	
Seat and Back Textile			
Fabric/Vinyl Grade 1	FG1/VG1	+ \$0	
COM	COM	+ \$40	
Fabric/Vinyl Grade 2	FG2/VG2	+ \$40	
Fabric/Vinyl Grade 3	FG3/VG3	+ \$84	
Fabric/Vinyl Grade 4	FG4/VG4	+ \$156	
Fabric/Vinyl Grade 5	FG5/VG5	+ \$228	
Fabric/Vinyl Grade 6	FG6/VG6	+ \$304	
Fabric/Vinyl Grade 7	FG7/VG7	+ \$378	

Please reference the [Textile Reference Guide](#) for pricing on fabric over grade 7. Additional CAL 133 information can be found on [page 15](#).

Please reference the [Fabric information](#) found on [page 17](#) for pricing on multi-upholstery.

6. Packaging

Packaging	Code	Price	
Back Attached to Seat, Base Separate	UC	+ \$0	

HEAVY DUTY TASK CHAIR

SPECIFICATIONS

	673 Task Chair Size 3
Dimensions	
Overall Width	30"
Overall Depth	28.5"
Overall Height	39.5"
Seat Width	23"
Seat Depth	19.5"
Seat Height	20.375"-23.25"
Back Width	22"
Back Height	21.5" (DT)
Materials	
COM	2.5 yd 2 yd (BN)
COL	44 sq ft 35 sq ft (BN)
Weight and Capacity	
Weight Armless	67 lb (DT)
Weight With Arms	79 lb (DT)
Weight Capacity Warranty	500 lb

Ballistic nylon back (BN).



Better

Non-Stop Heavy Duty XL

TASK STOOL

Around-the-clock comfort.

Designed for durability and backed by solid steel, Non-Stop™ differs from the typical chair construction in that all its mounting points are reinforced with heavy-gauge steel mounting brackets. These solid steel fasteners are second to none for reliability and ergonomic comfort in high-intensity environments where chairs perform all day, every day and support a wide range of users. This heavy duty chair is rated to accommodate users up to 500 pounds and easily handles the demands of 24-hour environments.



EFFECTIVE OCTOBER 17, 2022

Featured Models

GOOD :: \$1,980

Size 1 task stool, basic mechanism, armless, black nylon base, carpet casters, grade 1 textile

BETTER :: \$2,140

Size 1 task stool, basic mechanism, height-adjustable arms, black nylon base, carpet casters, grade 1 textile

BEST :: \$2,361

Size 1 task stool, basic mechanism, height-/width-adjustable arms, extended stool kit, polished aluminum base, carpet casters, grade 1 textile

NON-STOP

EFFECTIVE OCTOBER 17, 2022 | GSA SIN #: 33721

Features

- Reinforced heavy gauge steel mounting brackets
- Resilient multilayer cushioning
- Waterfall seat promotes proper leg circulation
- Heavy-duty 24/7 option warranted to 350 lb weight capacity

1. Back

Back Size and Style	Code	Price	
Heavy Duty Stool, 350 lb Capacity	671 B2	\$2,140	

Only available with the basic mechanism (swivel only).

2. Arms

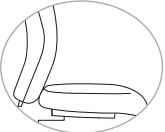
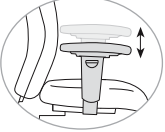
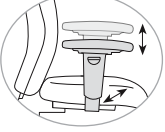

Arm Style	Code	Price	
Armless	A0	- \$160	
Height-Adjustable	A68	+ \$0	
Height-/Width-Adjustable	A69	+ \$30	

3. Base

Base	Code	Price	
Standard Stool Kit	S1HD	+ \$0	
Extended Stool Kit	S2HD	+ \$24	

HEAVY DUTY TASK STOOL

3. Base (Cont.)

Base Color and Material	Code	Price	
Black Nylon Base	B0	+ \$0	
Black Aluminum	B4	+ \$167	
Polished Aluminum Base	B5	+ \$167	

Casters or Glides	Code	Price	
Casters			

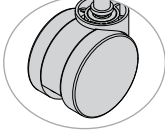
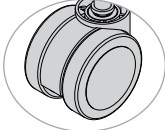
Heavy Duty Carpet Casters	C11	+ \$0	
Heavy Duty Hard Floor and Carpet Casters	C9	+ \$61	

Glides			
---------------	--	--	--

Glides for Task Chairs	C3	+ \$30	
------------------------	----	--------	---

4. Material (Cont.)

Protection	Code	Price
Fire Retardancy		
CAL 133, Fabric, Quantities 1–49	133F	+ \$99
CAL 133, Fabric, Quantities 50+	133F5	+ \$55
Ballistic Nylon		
Ballistic Nylon Back	BN	+ \$0
Seat and Back Textile		
Fabric/Vinyl Grade 1	FG1/VG1	+ \$0
COM	COM	+ \$40
Fabric/Vinyl Grade 2	FG2/VG2	+ \$40
Fabric/Vinyl Grade 3	FG3/VG3	+ \$84
Fabric/Vinyl Grade 4	FG4/VG4	+ \$156
Fabric/Vinyl Grade 5	FG5/VG5	+ \$228
Fabric/Vinyl Grade 6	FG6/VG6	+ \$304
Fabric/Vinyl Grade 7	FG7/VG7	+ \$378

Please reference the Textile Reference Guide for pricing on fabric over grade 7. Additional CAL 133 information can be found on [page 15](#).

Please reference the Fabric information found on [page 17](#) for pricing on multi-upholstery.

5. Packaging

Packaging	Code	Price
Knocked Down	KD	+ \$0
Back Attached to Seat, Base Separate	UC	+ \$80

HEAVY DUTY TASK STOOL

SPECIFICATIONS

	671B2 S1HD Task Stool	671B2 S2HD Extended Task Stool
Dimensions		
Overall Width	27.5"	27.5"
Overall Depth	26.5"	26.5"
Overall Height	40"	42.5"
Seat Width	19.5"	19.5"
Seat Depth	19.5"	19.5"
Seat Height	23"–31"	25.5"–35.5"
Back Width	20.5"	20.5"
Back Height	16"	16"
Materials		
COM	1.75 yd 1.3 yd (BN)	1.75 yd 1.3 yd (BN)
COL	30 sq ft 22 sq ft (BN)	30 sq ft 22 sq ft (BN)
Weight and Capacity		
Weight Armless	55 lb	55 lb
Weight With Arms	68 lb	68 lb
Weight Capacity Warranty	350 lb	350 lb

Ballistic nylon back (BN).

Novo

MESH BACK TASK CHAIR

*Hyper-customizable.
Super-ergonomic.*

Since its launch in 2016, our Novo™ task chair has been recognized for its designer-friendly features and superior ergonomics. With comfort-first design that's also customizable down to the last detail (we offer 13 choices for lumbar accent colors alone!), personalizing is easy—whether you need something professional for the boardroom or vibrant for a modern, collaborative space.



EFFECTIVE OCTOBER 17, 2022

Featured Models

GOOD :: \$723

Midback mesh with adjustable lumbar, black frame, swivel-tilt mechanism, height-adjustable arms, black nylon base, grade 1 textile

BETTER :: \$769

Highback mesh with adjustable lumbar, black frame, standard synchro mechanism, height-adjustable arms, black nylon base, grade 1 textile

BEST :: \$913

Highback mesh with adjustable lumbar, fog frame, standard synchro mechanism with seat-depth adjustment, multi-adjustable arms, fog nylon base, grade 1 textile



- Midback and highback task chairs
- Adjustable lumbar support comes standard on all models
- Three frame colors with matching base
- Three lumbar colors with 13 lumbar accent colors
- 12 mesh colors
- Basic, standard synchro and swivel-tilt mechanisms
- Three arm types: fixed, height-adjustable or multi-adjustable (height/width)
- Textured, easy-grip arms
- Adjustable seat depth (optional)
- Polished aluminum base (optional)
- Waterfall seat
- Standard 300 lb weight capacity warranty;
Super Duty Series 400 lb weight capacity warranty

1. Back

Back Size and Style	Code	Price	
Midback Mesh With Adjustable Lumbar Support	1033 BK1	\$741	

Highback Mesh With Adjustable Lumbar Support	1033 BK2	\$769	
--	----------	-------	---

Adjustable Lumbar Color	Code	Price	
Black	AL1	+ \$0	
White	AL2	+ \$0	
Fog	AL3	+ \$0	

MESH BACK TASK CHAIR

1. Back (Cont.)

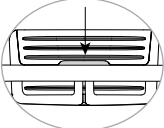

Lumbar Accent Color	Code	Price	
Apple	LA12	+ \$0	
Aqua	LA11	+ \$0	
Desert	LA3	+ \$0	
Electric Blue	LA5	+ \$0	
Fire	LA6	+ \$0	
Fog	LA4	+ \$0	
Grape	LA7	+ \$0	
Lemon	LA8	+ \$0	
Nickel	LA2	+ \$0	
Ocean	LA10	+ \$0	
Onyx	LA1	+ \$0	
Tangerine	LA9	+ \$0	
White	LA13	+ \$0	

2. Super Duty

Super Duty Series	Code	Price	
Large and Tall (Black Highback Frame With Enhanced Synchro Y Mechanism and Sport Height-Adjustable Arms)	LT	+ \$295	

See the Super Duty Guide on page 591 for additional options Heavy Duty and Large and Tall options.

3. Mechanism

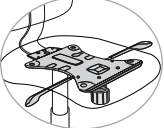
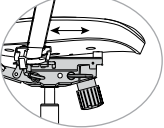
Mechanism Style	Code	Price	
Basic (Swivel Only)	B	- \$33	
Swivel-Tilt	T	- \$18	
Standard Synchro	F	+ \$0	
Standard Synchro With Seat-Depth Adjustment	F E3	+ \$79	

Seat-depth adjustment (F E3) not available on lower cylinder (CH4).

4. Frame

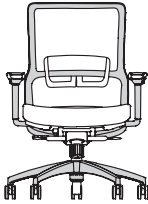
Frame Color	Code	Price	
Black	FC1	+ \$0	
White	FC12	+ \$35	
Fog	FC13	+ \$35	

5. Arms

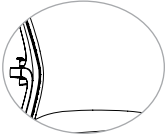
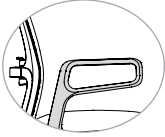
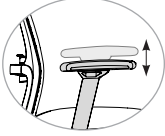
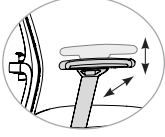
Arm Style	Code	Price	
Armless	AR0	- \$48	
Fixed Task	AR2	- \$10	
Height-Adjustable	AR4	+ \$0	
Multi-Adjustable (Height/Width)	AR6	+ \$30	

MESH BACK TASK CHAIR

6. Base

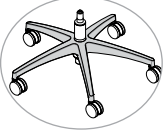
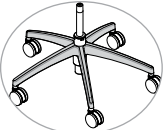
Base Color and Material	Code	Price	
Black Nylon Base (For Black Frame FC1)	B17	+ \$0	
White Nylon Base (For White Frame FC12)	B20	+ \$0	
Fog Nylon Base (For Fog Frame FC13)	B21	+ \$0	
Polished Aluminum Base	B18	+ \$113	

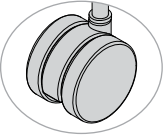
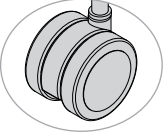
Casters or Glides	Code	Price	
Casters			
Carpet Casters	CS5	+ \$0	
Hard Floor and Carpet Casters	CS6	+ \$40	

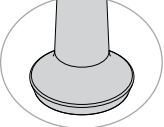
Glides			
Glides for Task Chairs	CS3	+ \$30	

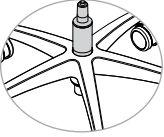
Cylinder Height	Code	Price	
Standard Cylinder	CH1	+ \$0	
Higher Cylinder	CH3	+ \$0	
Lower Cylinder	CH4	+ \$0	

Nylon bases must match frame color. The polished aluminum base (B18) can be ordered with any frame color.

Higher cylinder (CH3) and lower cylinder (CH4) options are only available with the black nylon base (B17). Style of nylon base will change with higher or lower cylinder.

7. Material

Protection	Code	Price
Fire Retardancy		
CAL 133, Fabric, Quantities 1-49	133F	+ \$99
CAL 133, Fabric, Quantities 50+	133F5	+ \$55
CAL 133, Leather, Any Quantity	133L	+ \$119
Mesh Color	Code	Price
Apple	MC31	+ \$0
Aqua	MC30	+ \$0
Desert	MC22	+ \$0
Electric Blue	MC24	+ \$0
Fire	MC25	+ \$0
Fog	MC23	+ \$0
Grape	MC26	+ \$0
Lemon	MC27	+ \$0
Nickel	MC21	+ \$0
Ocean	MC29	+ \$0
Onyx	MC20	+ \$0
Tangerine	MC28	+ \$0
Seat Textile	Code	Price
Fabric/Vinyl Grade 1	FG1/VG1	+ \$0
COM	COM	+ \$26
Fabric/Vinyl Grade 2	FG2/VG2	+ \$26
Fabric/Vinyl Grade 3	FG3/VG3	+ \$60
Fabric/Vinyl Grade 4	FG4/VG4	+ \$116
Fabric/Vinyl Grade 5	FG5/VG5	+ \$172
Fabric/Vinyl Grade 6	FG6/VG6	+ \$213
Fabric/Vinyl Grade 7	FG7/VG7	+ \$254
Leather Grade 1	LG1	+ \$300
COL	COL	+ \$380
Leather Grade 2	LG2	+ \$380
Leather Grade 3	LG3	+ \$480

Please reference the [Textile Reference Guide](#) for pricing on fabric over grade 7 and leather over grade 3. Additional CAL 133 information can be found on [page 15](#).

MESH BACK TASK CHAIR

8. Packaging

Packaging	Code	Price
Knocked Down	KD	+ \$0
Back Attached to Seat, Base Separate	UC	+ \$80
Fully Assembled in a Carton	AC	+ \$200



SPECIFICATIONS

	1033.BK1 Midback Task Chair	1033.BK2 Highback Task Chair
Dimensions		
Overall Width Armless	26"	26"
Overall Width With Arms	26"	26"
Overall Depth	26"	26"
Overall Height	36"	39"
Seat Width	20"	20"
Seat Depth	16.5"-18.5"	16.5"-18.5"
Seat Height	16"-19.75" (B) 16.25"-20" (T) 16.75"-20.25" (F) 17"-20.625" (F/E3)	16"-19.75" (B) 16.25"-20" (T) 16.75"-20.25" (F) 17"-20.625" (F/E3)
Seat Height With Higher Cylinder	16.25"-21.25" (B) 16.5"-21.5" (T) 17"-22" (F) 17.25"-22.25" (F/E3)	16.25"-21.25" (B) 16.5"-21.5" (T) 17"-22" (F) 17.25"-22.25" (F/E3)
Seat Height With Lower Cylinder	14.5"-18.25" (B) 14.75"-17.5" (T) 15.25"-18" (F) 15.5"-18.25" (F/E3)	14.5"-18.25" (B) 14.75"-17.5" (T) 15.25"-18" (F) 15.5"-18.25" (F/E3)
Back Width	19"	19"
Back Height	20"	23"
Materials		
COM	1 yd	1 yd
COL	17 sq ft	17 sq ft
Weight and Capacity		
Weight Armless	31 lb	32 lb
Weight With Arms	37 lb	38 lb
Weight Capacity Warranty	300 lb	300 lb

Basic mechanism (B). Swivel-tilt mechanism (T). Standard synchro mechanism (F).
Seat-depth adjustment (E3). Enhanced synchro mechanism (Y).

MESH BACK TASK CHAIR

SPECIFICATIONS

	1033.BK2 LT Large and Tall Task Chair
Dimensions	
Overall Width Armless	26"
Overall Width With Arms	29"
Overall Depth	29"
Overall Height	39"
Seat Width	22"
Seat Depth	17.5"-19.5"
Seat Height	16.75"-19.75" (Y)
Seat Height With Higher Cylinder	20.5"-25"
Back Width	19"
Back Height	21.5"
Materials	
COM	1.15 yd
COL	18 sq ft
Weight and Capacity	
Weight Armless	46 lb
Weight With Arms	52 lb
Weight Capacity Warranty	400 lb

Enhanced synchro mechanism (Y).

Novo

MESH BACK TASK STOOL

*Hyper-customizable.
Super-ergonomic.*

Since its launch in 2016, our Novo™ collection has been recognized for its designer-friendly features and superior ergonomics. With comfort-first design that's also customizable down to the last detail (we offer 13 choices for lumbar accent colors alone!), personalizing is easy—whether you need something professional for the boardroom or vibrant for a modern, collaborative space.



reddot design award
winner 2017



Best

EFFECTIVE OCTOBER 17, 2022

Featured Models

GOOD :: \$770

Midback mesh with adjustable lumbar, basic mechanism, black frame, armless, black nylon base, carpet casters, grade 1 textile

BETTER :: \$818

Midback mesh with adjustable lumbar, basic mechanism, black frame, height-adjustable arms, black nylon base, carpet casters, grade 1 textile

BEST :: \$883

Midback mesh with adjustable lumbar, basic mechanism, white frame, multi-adjustable arms, white nylon base, carpet casters, grade 1 textile

Features

- Midback task stool
- Adjustable lumbar support comes standard on all models
- Three frame colors with matching base
- Three lumbar colors with 13 lumbar accent colors
- 12 mesh colors
- Basic mechanism
- Three arm types: fixed, height-adjustable or multi-adjustable (height/width)
- Textured, easy-grip arms
- Polished aluminum base (optional)
- Waterfall seat
- Standard 300 lb weight capacity

1. Back

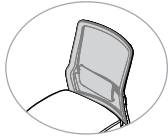
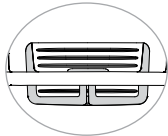
Back Size and Style	Code	Price	
Midback Mesh Task Stool With Adjustable Lumbar Support	1033 BK1	\$818	
Adjustable Lumbar Color	Code	Price	
Black	AL1	+ \$0	
White	AL2	+ \$0	
Fog	AL3	+ \$0	

MESH BACK TASK STOOL

1. Back (Cont.)

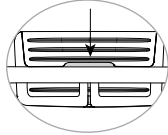
Lumbar Accent Color	Code	Price	
Apple	LA12	+ \$0	
Aqua	LA11	+ \$0	
Desert	LA3	+ \$0	
Electric Blue	LA5	+ \$0	
Fire	LA6	+ \$0	
Fog	LA4	+ \$0	
Grape	LA7	+ \$0	
Lemon	LA8	+ \$0	
Nickel	LA2	+ \$0	
Ocean	LA10	+ \$0	
Onyx	LA1	+ \$0	
Tangerine	LA9	+ \$0	
White	LA13	+ \$0	

2. Mechanism

Mechanism Style	Code	Price	
Basic (Swivel Only)	B	+ \$0	



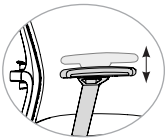

3. Frame

Frame Color	Code	Price	
Black	FC1	+ \$0	
White	FC12	+ \$35	
Fog	FC13	+ \$35	

4. Arms

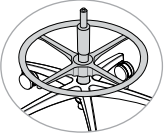
Arm Style	Code	Price	
Armless	AR0	- \$48	
Fixed Task	AR2	- \$10	
Height-Adjustable	AR4	+ \$0	
Multi-Adjustable (Height/Width)	AR6	+ \$30	

5. Base

Base	Code	Price	
Stool Kit	S1	+ \$0	
Extended Stool Kit	S2	+ \$24	
Base Color and Material	Code	Price	
Black Nylon Base (For Black Frame FC1)	B17	+ \$0	
White Nylon Base (For White Frame FC12)	B20	+ \$0	
Fog Nylon Base (For Fog Frame FC13)	B21	+ \$0	
Polished Aluminum Base	B18	+ \$113	

MESH BACK TASK STOOL

5. Base (Cont.)

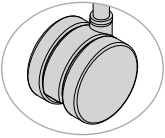
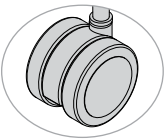
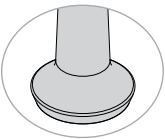
Casters or Glides	Code	Price	
Casters			
Carpet Casters	CS5	+ \$0	
Hard Floor and Carpet Casters	CS6	+ \$40	
Glides			
Glides for Task Chairs	CS3	+ \$30	

Nylon bases must match frame color. The polished aluminum base (B18) can be ordered with any frame color.

6. Material

Protection	Code	Price	
Fire Retardancy			
CAL 133, Fabric, Quantities 1-49	133F	+ \$99	
CAL 133, Fabric, Quantities 50+	133F5	+ \$55	
CAL 133, Leather, Any Quantity	133L	+ \$119	
Mesh Color	Code	Price	
Apple	MC31	+ \$0	
Aqua	MC30	+ \$0	
Desert	MC22	+ \$0	
Electric Blue	MC24	+ \$0	
Fire	MC25	+ \$0	
Fog	MC23	+ \$0	
Grape	MC26	+ \$0	
Lemon	MC27	+ \$0	
Nickel	MC21	+ \$0	
Ocean	MC29	+ \$0	
Onyx	MC20	+ \$0	
Tangerine	MC28	+ \$0	

6. Material (Cont.)

Seat Textile	Code	Price
Fabric/Vinyl Grade 1	FG1/VG1	+ \$0
COM	COM	+ \$26
Fabric/Vinyl Grade 2	FG2/VG2	+ \$26
Fabric/Vinyl Grade 3	FG3/VG3	+ \$60
Fabric/Vinyl Grade 4	FG4/VG4	+ \$116
Fabric/Vinyl Grade 5	FG5/VG5	+ \$172
Fabric/Vinyl Grade 6	FG6/VG6	+ \$213
Fabric/Vinyl Grade 7	FG7/VG7	+ \$254
Leather Grade 1	LG1	+ \$300
COL	COL	+ \$380
Leather Grade 2	LG2	+ \$380
Leather Grade 3	LG3	+ \$480

Please reference the [Textile Reference Guide](#) for pricing on fabric over grade 7 and leather over grade 3. Additional CAL 133 information can be found on [page 15](#).

MESH BACK TASK STOOL

7. Packaging

Packaging	Code	Price
Knocked Down	KD	+ \$0
Back Attached to Seat, Base Separate	UC	+ \$80
Fully Assembled in a Carton	AC	+ \$200

SPECIFICATIONS

	1033.BK1 S1 Midback Task Stool	1033.BK1 S2 Extended Task Stool
Dimensions		
Overall Width	26"	27"
Overall Depth	26"	27"
Overall Height	39"	42"
Seat Width	20"	20"
Seat Depth	16.5"	16.5"
Seat Height	21.375"-29"	24.25"-34.25"
Back Width	19"	19"
Back Height	20"	20"
Materials		
COM	1 yd	1 yd
COL	17 sq ft	17 sq ft
Weight and Capacity		
Weight Armless	29 lb	30 lb
Weight With Arms	35 lb	36 lb
Weight Capacity Warranty	300 lb	300 lb



OnCall

LIGHT TASK CHAIR AND TASK STOOL

*High performance,
low maintenance.*

Perfect for collaboration spaces, the lightweight OnCall™ task chair and stool feature the collection's signature built-in crescent handle and back cut-out. Mix and match with fabrics from our vast collection for the seat, back or both to create an affordable addition to creative workstations or any impromptu meeting.



EFFECTIVE OCTOBER 17, 2022

Featured Models

GOOD :: \$435

Task chair, all plastic, swivel-tilt mechanism, armless, carpet casters

BETTER :: \$493

Task chair, upholstered seat and plastic back, swivel-tilt mechanism, armless, carpet casters, grade 1 textile

BEST :: \$609

Task chair, upholstered seat and back, swivel-tilt mechanism, fixed arms, carpet casters, grade 1 textile



Features

- Task chair and task stool
- Fully upholstered, upholstered seat or plastic
- Three plastic colors
- Built-in pull handle
- 250 lb weight capacity warranty
- Complements OnCall multipurpose chair and bar stool; see [page 258](#)

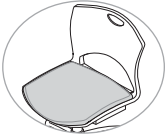
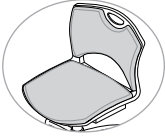
1. Back

Back and Seat Style	Code	Price	
Plastic	No Code	\$435	
Upholstered Seat Only	US	\$493	
Upholstered Seat and Back	UP	\$551	

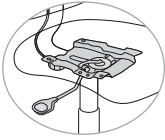

2. Mechanism

Mechanism Style	Code	Price	
Basic (Swivel Only)	B	- \$50	
Swivel-Tilt	T	+ \$0	

Swivel-tilt (T) mechanism not available on task stool models (S1/S2).

LIGHT TASK CHAIR AND TASK STOOL

3. Frame

Frame Type	Code	Price	
Task	90T	+ \$0	
Task Stool	90TB S1	+ \$132	
Extended Task Stool	90TB S2	+ \$156	

4. Arms

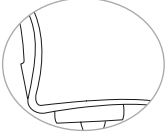
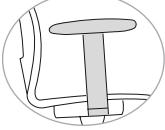
Arm Style	Code	Price	
Armless	A0	+ \$0	
Fixed Task	A42	+ \$58	

5. Base

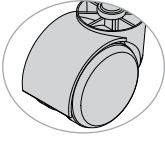
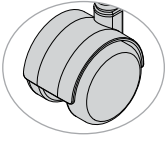
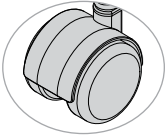
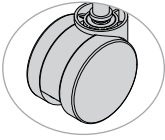
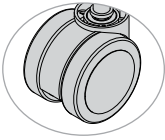
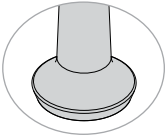
Casters or Glides	Code	Price	
Casters			
Carpet Casters	C6	+ \$0	
Hard Floor and Carpet Casters	C1	+ \$40	
Self-Locking Carpet Casters	C2	+ \$30	
Self-Locking Hard Floor and Carpet Casters	C7	+ \$61	
Heavy Duty Carpet Casters	C11	+ \$30	
Heavy Duty Hard Floor and Carpet Casters	C9	+ \$61	
Glides			
Glides for Task Chairs	C3	+ \$30	

Self-locking casters (C2/C7) lock only when not in use.

6. Material

Protection	Code	Price	
Fire Retardancy			
CAL 133, Fabric, Quantities 1-49	133F	+ \$99	
CAL 133, Fabric, Quantities 50+	133F5	+ \$55	
CAL 133, Plastic, Any Quantity	133P	+ \$45	
Shell Color	Code	Price	
Black	SC1	+ \$0	
Navy	SC5	+ \$0	
Slate	SC8	+ \$0	

LIGHT TASK CHAIR AND TASK STOOL

6. Material

Textile	Code	Price	
Seat Textile Only (For US)			
Fabric/Vinyl Grade 1	FG1/VG1	+ \$0	
COM	COM	+ \$22	
Fabric/Vinyl Grade 2	FG2/VG2	+ \$22	
Fabric/Vinyl Grade 3	FG3/VG3	+ \$45	
Fabric/Vinyl Grade 4	FG4/VG4	+ \$77	
Fabric/Vinyl Grade 5	FG5/VG5	+ \$116	
Fabric/Vinyl Grade 6	FG6/VG6	+ \$159	
Fabric/Vinyl Grade 7	FG7/VG7	+ \$200	
Seat and Back Textile (For UP)			
Fabric/Vinyl Grade 1	FG1/VG1	+ \$0	
COM	COM	+ \$34	
Fabric/Vinyl Grade 2	FG2/VG2	+ \$34	
Fabric/Vinyl Grade 3	FG3/VG3	+ \$74	
Fabric/Vinyl Grade 4	FG4/VG4	+ \$121	
Fabric/Vinyl Grade 5	FG5/VG5	+ \$174	
Fabric/Vinyl Grade 6	FG6/VG6	+ \$235	
Fabric/Vinyl Grade 7	FG7/VG7	+ \$296	

Please reference the [Textile Reference Guide](#) for pricing on fabric over grade 7. Additional CAL 133 information can be found on [page 15](#).

7. Packaging

Packaging	Code	Price	
Back Attached to Seat, Base Separate	UC	+ \$0	
Fully Assembled in a Carton	AC	+ \$120	

EFFECTIVE OCTOBER 17, 2022 | GSA SIN #: 33721

SPECIFICATIONS

	90T Task Chair	90T S1 Task Stool	90T S2 Extended Task Stool
Dimensions			
Overall Width	26"	26"	26"
Overall Depth	26.5"	26"	26"
Overall Height	34"	37.5"	41.5"
Seat Width	18"	18"	18"
Seat Depth	17.5"	17.5"	17.5"
Seat Height	16.5"-20.5"	20"-28"	24"-34"
Back Width	19"	19"	19"
Back Height	15"	15"	15"
Materials			
COM	0.8 (US) 0.85 (UP)	0.8 (US) 0.85 (UP)	0.8 (US) 0.85 (UP)
Weight and Capacity			
Weight Armless	26.2 lb	25.5 lb	25.5 lb
Weight With Arms	32.2 lb	29 lb	29 lb
Weight Capacity Warranty	250 lb	250 lb	250 lb



Orbix

LIGHT TASK CHAIR AND STOOL

Everything you need (and more).

More design. More comfort. More models to match the needs of any space. The robust build of Orbix features an ultra-supportive and extra-wide backrest with hundreds of diamond-cut perforations for unmatched breathability and comfort.



Upholstered

EFFECTIVE OCTOBER 17, 2022

Featured Models

PLASTIC :: \$374

Light task chair, plastic seat and back, carpet casters

UPHOLSTERED :: \$432

Light task chair, upholstered seat, plastic back, carpet casters, grade 1 textile



STOOL :: \$588

Extended light task stool, upholstered seat, plastic back, carpet casters, grade 1 textile

Features

- Consistent, cohesive look with a broad statement of line offers options to fit any space
- Upscale style with bold lines and striking detail
- Ultra-supportive, extra-wide backrest provides lasting comfort
- Hundreds of diamond-cut perforations offer unmatched breathability and visual transparency
- Integrated clean-out makes it easy to wipe down
- Collection includes wire rod, bar stool, light task and task stool; see [page 262](#) for the wire rod chair and bar stool
- 14 shell colors to coordinate with optional upholstered seat
- 300 lb weight capacity warranty

1. Frame

Frame Type	Code	Price	
Task Chair	1132 FT3 CH1	\$374	
Standard Task Stool	1132 FT3 S21	\$506	
Extended Task Stool	1132 FT3 S22	\$530	

2. Seat and Back

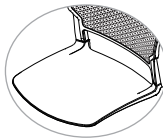
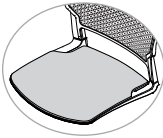
Seat Style	Code	Price	
Plastic	PS	+ \$0	
Upholstered Seat	US	+ \$58	

LIGHT TASK CHAIR AND STOOL

2. Seat and Back (Cont.)

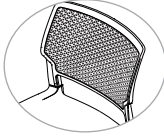
Back Style	Code	Price	
Plastic	PB	+ \$0	

3. Arms

Arm Style	Code	Price	
Armless	ARO	+ \$0	

4. Base

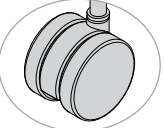
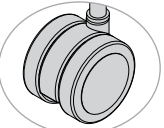
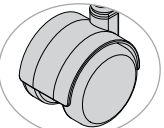
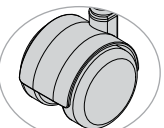
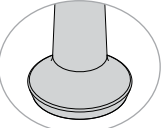
Casters or Glides	Code	Price	
Casters			
Carpet Casters	CS5	+ \$0	
Hard Floor and Carpet Casters	CS6	+ \$40	
Self-Locking Carpet Casters	C20	+ \$30	
Self-Locking Hard Floor and Carpet Casters	C19	+ \$61	
Glides			
Glides for Task Chairs	CS3	+ \$30	

Self-locking casters (C20/C19) lock only when not in use.

5. Material

Shell Color	Code	Price
Apple	SC24	+ \$0
Arctic	SC21	+ \$0
Bisque	SC7	+ \$0
Black	SC1	+ \$0
Chocolate	SC4	+ \$0
Latte	SC20	+ \$0
Lagoon	SC15	+ \$0
Lemon	SC25	+ \$0
Navy	SC5	+ \$0
Pacific	SC22	+ \$0
Red	SC19	+ \$0
Slate	SC8	+ \$0
Sterling	SC18	+ \$0
Tangerine	SC23	+ \$0

Seat Textile	Code	Price
Fabric/Vinyl Grade 1	FG1/VG1	+ \$0
COM	COM	+\$22
Fabric/Vinyl Grade 2	FG2/VG2	+\$22
Fabric/Vinyl Grade 3	FG3/VG3	+\$45
Fabric/Vinyl Grade 4	FG4/VG4	+\$77
Fabric/Vinyl Grade 5	FG5/VG5	+\$116
Fabric/Vinyl Grade 6	FG6/VG6	+\$159
Fabric/Vinyl Grade 7	FG7/VG7	+\$200

6. Packaging

Packaging	Code	Price
Back Attached to Seat, Base Separate	UC	+ \$0
Fully Assembled in a Carton	AC	+ \$120

LIGHT TASK CHAIR AND STOOL

SPECIFICATIONS

	1132 FT3 CH1 Light Task Chair	1132 FT3 S21 Light Task Stool	1132 FT3 S22 Extended Task Stool
Dimensions			
Overall Width Armless	28.25"	28.25"	28.25"
Overall Depth	27.25"	27.25"	27.25"
Overall Height	32.75"-37"	36.25"-43.25"	39"-48.75"
Seat Width	18.25"	18.25"	18.25"
Seat Depth	17.25"	17.25"	17.25"
Seat Height	17.5"-22.75"	21"-28"	23.25"-33.75"
Back Width	19.75"	19.75"	19.75"
Back Height	17.5"	17.5"	17.5"
Materials			
COM	0.75 yd	0.75 yd	0.75 yd
Weight and Capacity			
Weight Armless	26 lb (PS) 27 lb (US)	3 lb (PS) 32 lb (US)	31 lb (PS) 32 lb (US)
Weight Capacity Warranty	300 lb	300 lb	300 lb

Plastic seat (PS). Upholstered seat (US).



Plastic

Prava

CONFERENCE CHAIR

Command performance.

The Jorge Pensi designed Prava™ chair has double-stitched detailing and revolutionary molded-foam construction. The midback model is ideal for conference room use while the highback is well suited for any executive. A plush foam cushion in the center of the backrest offers ultimate comfort. A wide array of comfort and control options are available including three arm styles and a choice of swivel-tilt, knee-tilt or enhanced synchro adjustments. Modern and sophisticated with restrained elegance, Prava embodies the precise balance between refinement and comfort.



EFFECTIVE OCTOBER 17, 2022

Featured Models

GOOD :: \$1,084

Midback, swivel-tilt mechanism, black fixed loop arms, black nylon base, carpet casters, grade 1 textile

BETTER :: \$1,117

Midback, knee-tilt mechanism, black fixed loop arms, black nylon base, carpet casters, grade 1 textile

BEST :: \$1,379

Highback, enhanced synchro mechanism, fully adjustable black nylon arms, polished aluminum base, carpet casters, grade 1 textile

Features

- Sleek European styling
- Soft, plush foam back
- Perimeter foam for a tailored profile
- Jorge Pensi design
- Double-stitch detailing
- Aluminum accents
- Waterfall seat
- 300 lb weight capacity warranty

1. Back

Back Size and Style	Code	Price	
---------------------	------	-------	--

Midback

6422

\$1,117

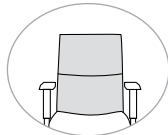

Highback

6423

\$1,149

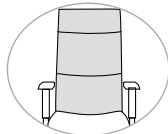

Back Options	Code	Price	
--------------	------	-------	--

Headrest,
Matches Chair Textile

HR1C0

+ \$95

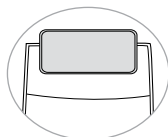

Headrest is available on highback models only.

CONFERENCE CHAIR

2. Mechanism

Mechanism Style	Code	Price	
-----------------	------	-------	--

Swivel-Tilt

T

- \$33



Knee-Tilt

K

+ \$0



Enhanced Synchro

Y

+ \$57

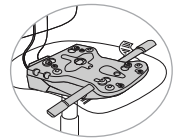

Enhanced Synchro With
Seat-Depth Adjustment

Y E3

+ \$136

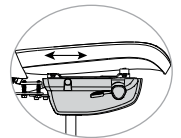

3. Arms

Arm Style	Code	Price	
-----------	------	-------	--

Armless

A0

- \$75

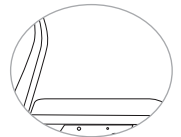

Black Fixed Loop

A111

+ \$0



Silver Fixed Metallic Loop

A112

+ \$74

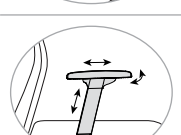

Fully Adjustable Black (6-Way)

AR8

+ \$60

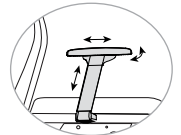

4. Base

Base Color and Material	Code	Price
Black Nylon Base	B0	+ \$0
Silver Metallic Base	B11	+ \$113
Polished Aluminum Base	B3	+ \$113
Brushed Aluminum Base	B8	+ \$113



Casters	Code	Price
---------	------	-------

Carpet Casters	C16	+ \$0
----------------	-----	-------

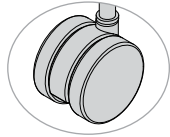

Hard Floor and Carpet Casters	C17	+ \$40
-------------------------------	-----	--------

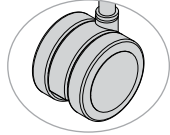

Self-Locking Carpet Casters	C20	+ \$30
-----------------------------	-----	--------

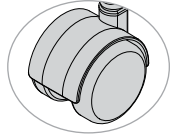

Self-Locking Hard Floor and Carpet Casters	C19	+ \$64
--	-----	--------

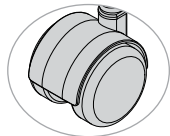

Self-locking casters (C19/C20) lock only when not in use.

5. Material

Protection	Code	Price
Fire Retardancy		
CAL 133, Fabric, Quantities 1-49	133F	+ \$99
CAL 133, Fabric, Quantities 50+	133F5	+ \$55
CAL 133, Leather, Any Quantity	133L	+ \$119

CONFERENCE CHAIR

5. Material

Seat and Back Textile	Code	Price
Fabric/Vinyl Grade 1	FG1/VG1	+ \$0
COM	COM	+ \$36
Fabric/Vinyl Grade 2	FG2/VG2	+ \$36
Fabric/Vinyl Grade 3	FG3/VG3	+ \$78
Fabric/Vinyl Grade 4	FG4/VG4	+ \$135
Fabric/Vinyl Grade 5	FG5/VG5	+ \$196
Fabric/Vinyl Grade 6	FG6/VG6	+ \$263
Fabric/Vinyl Grade 7	FG7/VG7	+ \$332
Leather Grade 1	LG1	+ \$340
COL	COL	+ \$460
Leather Grade 2	LG2	+ \$460
Leather Grade 3	LG3	+ \$600

Please reference the [Textile Reference Guide](#) for pricing on fabric over grade 7 and leather over grade 3. Additional CAL 133 information can be found on [page 15](#).

Please reference the [Fabric information](#) found on [page 17](#) for pricing on multi-upholstery.

6. Packaging

Packaging	Code	Price
Knocked Down	KD	+ \$0
Back Attached to Seat, Base Separate	UC	+ \$80
Fully Assembled in a Carton	AC	+ \$200

EFFECTIVE OCTOBER 17, 2022 | GSA SIN #: 33721

SPECIFICATIONS

	6422 Midback	6423 Highback
Dimensions		
Overall Width Armless	19"	19"
Overall Width With Arms	26.75"	26.75"
Overall Depth	26.3"	26.3"
Overall Height	43.125"	46.125"
Seat Width	19"	19"
Seat Depth	19"	19"
Seat Height	16.75"-19.75" (T) 16.75"-20.75" (K) 16"-20" (Y)	16.75"-19.75" (T) 16.75"-20.75" (K) 16"-20" (Y)
Back Width	18.25"	18.25"
Back Height	23.75"	26.75"
Materials		
COM	2 yd	2.25 yd
COL	35 sq ft	40 sq ft
Weight and Capacity		
Weight Armless	42 lb	44 lb
Weight With Arms	50 lb	52 lb
Weight Capacity Warranty	300 lb	300 lb

Swivel-tilt mechanism (T). Knee-tilt mechanism (K). Enhanced synchro mechanism (Y).



Good

ReAlign

TASK CHAIR

*When sleek contour
and control align.*

Contemporary tailored lines, a thin profile and enduring comfort make ReAlign™ a perfect chair for both task and conference use. The sculpted, ergonomically designed back and back-height adjustment provide lumbar support in both midback and highback styles. Seat-depth adjustment, ballistic nylon back and a Heavy Duty 24/7 option expand the versatility of this collection. With five control mechanisms and five arm styles to choose from, ReAlign can solve almost any office requirement.



Best

EFFECTIVE OCTOBER 17, 2022

Featured Models

GOOD :: \$907

Midback, swivel-tilt mechanism, height-adjustable arms, black nylon base, carpet casters, grade 1 textile

BETTER :: \$997

Midback, enhanced synchro mechanism, height-adjustable arms, black nylon base, carpet casters, grade 1 textile

BEST :: \$1,127

Highback, enhanced synchro mechanism, fixed loop arms, high profile polished aluminum base, carpet casters, grade 1 vinyl

Features

- Thin profile design
- Ergonomic concave/convex back
- Internal back-height adjustment (on Y & M mechanism only)
- CAL 133 approved models
- 300 lb weight capacity warranty; 350 lb Heavy Duty 24/7 weight capacity warranty

1. Back

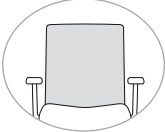
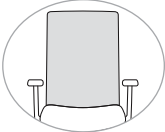
Back Size and Style	Code	Price	
Midback	681	\$997	
Highback	682	\$1,029	



2. Super Duty

Super Duty Series	Code	Price	
Heavy Duty	HD	+ \$126	



Heavy Duty option only compatible with multi-function (M), enhanced synchro (Y) and euro glide (A2) mechanisms. See the Super Duty Guide on [page 591](#) for additional LT and HD options.

TASK CHAIR

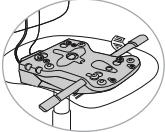
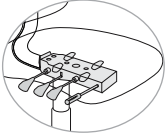
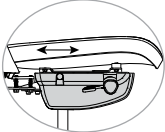
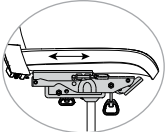
3. Mechanism

Mechanism Style	Code	Price	
Basic (Swivel Only)	B	- \$127	
Swivel-Tilt	T	- \$90	
Knee-Tilt	K	- \$57	
Enhanced Synchro	Y	+ \$0	
Multi-Function	M	+ \$36	
Enhanced Synchro With Seat-Depth Adjustment	Y E3	+ \$79	
Multi-Function With Seat-Depth Adjustment	M E3	+ \$115	

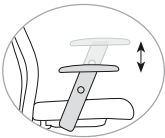
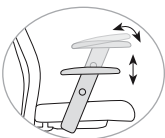
4. Arms

Arm Style	Code	Price	
Armless	A0	- \$90	
Fixed Loop	A77	- \$15	
Height-Adjustable	A73	+ \$0	
Height-Adjustable With Pivot	A75	+ \$10	
Height-/Width-Adjustable	A74	+ \$25	
Height-/Width-Adjustable With Pivot	A76	+ \$45	

TASK CHAIR

5. Base

Base Color and Material	Code	Price	
Black Nylon Base	B0	+ \$0	
Heavy Duty Black Nylon Base, 26" (For HD)	B7	+ \$0	
High Profile Polished Aluminum Base	B3	+ \$113	
Low Profile Base With Higher Cylinder	S8	+ \$0	

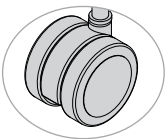
Casters or Glides	Code	Price	
Casters			
Carpet Casters	C15	+ \$0	
Hard Floor and Carpet Casters	C14	+ \$40	
Self-Locking Carpet Casters	C20	+ \$30	
Self-Locking Hard Floor and Carpet Casters	C19	+ \$64	

High profile polished aluminum base (B3) is not available with seat-depth adjustment (E3).

5. Base (Cont.)

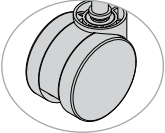
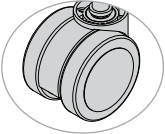
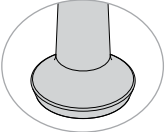
Castors or Glides	Code	Price	
Heavy Duty Casters			
Heavy Duty Carpet Casters	C11	+ \$0	
Heavy Duty Hard Floor and Carpet Casters	C9	+ \$61	
Glides			
Glides for Task Chairs	C3	+ \$30	

Higher cylinder (S8) must use enhanced synchro mechanism (Y) and is only available with low profile base and corresponding casters.

Self-locking casters (C20/C19) lock only when not in use. Heavy Duty casters must use enhanced synchro (Y) mechanism.

6. Material

Protection	Code	Price	
Fire Retardancy			
CAL 133, Fabric, Quantities 1-49	133F	+ \$99	
CAL 133, Fabric, Quantities 50+	133F5	+ \$55	
CAL 133, Leather, Any Quantity	133L	+ \$119	
Ballistic Nylon			
Ballistic Nylon Back	BN	+ \$0	

TASK CHAIR

6. Material

Seat and Back Textile	Code	Price	
Fabric/Vinyl Grade 1	FG1/VG1	+ \$0	
COM	COM	+ \$36	
Fabric/Vinyl Grade 2	FG2/VG2	+ \$36	
Fabric/Vinyl Grade 3	FG3/VG3	+ \$78	
Fabric/Vinyl Grade 4	FG4/VG4	+ \$135	
Fabric/Vinyl Grade 5	FG5/VG5	+ \$196	
Fabric/Vinyl Grade 6	FG6/VG6	+ \$263	
Fabric/Vinyl Grade 7	FG7/VG7	+ \$332	
Leather Grade 1	LG1	+ \$340	
COL	COL	+ \$460	
Leather Grade 2	LG2	+ \$460	
Leather Grade 3	LG3	+ \$600	

Please reference the [Textile Reference Guide](#) for pricing on fabric over grade 7 and leather over grade 3.

Please reference the Fabric information found on [page 17](#) for pricing on multi-upholstery.

7. Packaging

Packaging	Code	Price	
Knocked Down	KD	+ \$0	
Back Attached to Seat, Base Separate	UC	+ \$80	
Fully Assembled In a Carton	AC	+ \$200	

EFFECTIVE OCTOBER 17, 2022 | GSA SIN #: 33721

SPECIFICATIONS

	681 Midback Task Chair	682 Highback Task Chair
Dimensions		
Overall Width	27"	27"
Overall Depth	27"	27"
Overall Height	37.5"	40.5"
Seat Width	19"	19"
Seat Depth	19"	19"
Seat Height (Mechanism)	17"-20" (B)	17"-20" (B)
	16.625"-19.75" (T)	16.625"-19.75" (T)
	16.75"-20.25" (K)	16.75"-20.25" (K)
	16.5"-20" (I)	16.5"-20" (I)
	16.75"-20.25" (Y/M/A2)	16.75"-20.25" (Y/M/A2)
Back Width	19"	19"
Back Height	23"	26"
Materials		
COM	2 yd	2.2 yd
	1.7 yd (BN)	1.75 yd (BN)
COL	34 sq ft	40 sq ft
	30 sq ft (BN)	32 sq ft (BN)
Weight and Capacity		
Weight Armless (Mechanism)	38 lb (B)	39 lb (B)
	41 lb (T)	42 lb (T)
	49 lb (K)	50 lb (K)
	49 lb (Y/M)	50 lb (Y/M)
Weight With Arms	45 lb (B)	46 lb (B)
	48 lb (T)	49 lb (T)
	56 lb (K)	57 lb (K)
	56 lb (Y/M)	57 lb (Y/M)
Weight	300 lb	300 lb
Capacity Warranty	350 lb (HD)	350 lb (HD)

Basic mechanism (B). Swivel-tilt mechanism (T). Knee-tilt mechanism (K). Enhanced synchro mechanism (Y). Multi-function mechanism (M). Ballistic nylon back (BN). Heavy Duty (HD).

ReAlign

TASK STOOL

*When sleek contour
and control align.*

Contemporary tailored lines, a thin profile and enduring comfort make ReAlign™ a perfect stool for task use. The sculpted, ergonomically designed back and back-height adjustment provide lumbar support in both midback and highback styles. Seat-depth adjustment and ballistic nylon back expand the versatility of this collection. With five arm styles to choose from, ReAlign can solve almost any office requirement.



EFFECTIVE OCTOBER 17, 2022

Featured Models

GOOD :: \$956

Midback stool, basic mechanism, armless, standard stool kit, black nylon base, carpet casters, grade 1 textile

BETTER :: \$1,046

Midback stool, basic mechanism, height-adjustable arms, standard stool kit, black nylon base, carpet casters, grade 1 textile

BEST :: \$1,228

Midback stool, basic mechanism, height-/width-adjustable arms with pivot, extended stool kit, high profile polished aluminum base, grade 1 textile

Features

- Thin profile design
- Ergonomic concave/convex back
- 300 lb weight capacity warranty;
350 lb Heavy Duty 24/7 weight capacity warranty

1. Back

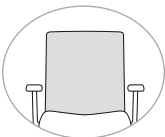
Back Size and Style	Code	Price	
Midback	681	\$1,046	

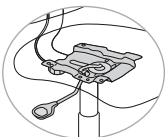

ReAlign task stool (681B) comes with basic mechanism (swivel only).

2. Mechanism



Mechanism Style	Code	Price	
Basic (Swivel Only)	B	+ \$0	

TASK STOOL

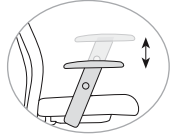
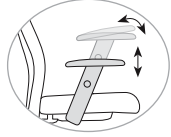
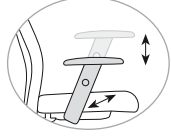
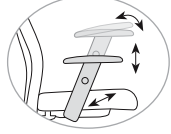
3. Arms

Arm Style	Code	Price	
Armless	A0	- \$90	
Fixed Loop	A77	- \$15	
Height-Adjustable	A73	+ \$0	
Height-Adjustable With Pivot	A75	+ \$10	
Height-/Width-Adjustable	A74	+ \$25	
Height-/Width-Adjustable With Pivot	A76	+ \$45	

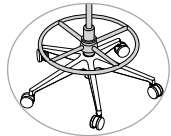
4. Base

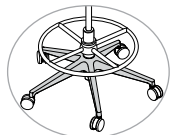
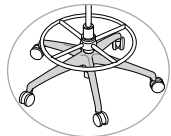
Stool Kit	Code	Price	
Standard Stool Kit	S1	+ \$0	
Extended Stool Kit	S2	+ \$24	
Base Color and Material	Code	Price	
Standard Black Nylon Base	N	+ \$0	
High Profile Polished Aluminum Base	B3	+ \$113	

4. Base (Cont.)

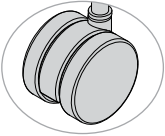
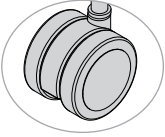
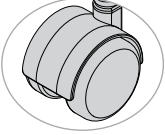
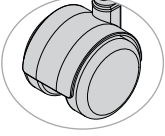
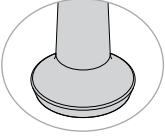
Casters or Glides	Code	Price	
Casters			
Carpet Casters	C15	+ \$0	
Hard Floor and Carpet Casters	C14	+ \$40	
Self-Locking Carpet Casters	C20	+ \$30	
Self-Locking Hard Floor and Carpet Casters	C19	+ \$64	
Glides			
Glides for Task Chairs	C3	+ \$30	

Self-locking casters (C19/C20) lock only when not in use.

5. Material

Protection	Code	Price	
Fire Retardancy			
CAL 133, Fabric, Quantities 1-49	133F	+ \$99	
CAL 133, Fabric, Quantities 50+	133F5	+ \$55	
CAL 133, Leather, Any Quantity	133L	+ \$119	
Ballistic Nylon			
Ballistic Nylon Back	BN	+ \$0	

TASK STOOL

5. Material (Cont.)

Seat and Back Textile	Code	Price	
Fabric/Vinyl Grade 1	FG1/VG1	+ \$0	
COM	COM	+ \$36	
Fabric/Vinyl Grade 2	FG2/VG2	+ \$36	
Fabric/Vinyl Grade 3	FG3/VG3	+ \$78	
Fabric/Vinyl Grade 4	FG4/VG4	+ \$135	
Fabric/Vinyl Grade 5	FG5/VG5	+ \$196	
Fabric/Vinyl Grade 6	FG6/VG6	+ \$263	
Fabric/Vinyl Grade 7	FG7/VG7	+ \$332	
Leather Grade 1	LG1	+ \$340	
COL	COL	+ \$460	
Leather Grade 2	LG2	+ \$460	
Leather Grade 3	LG3	+ \$600	

Please reference the [Textile Reference Guide](#) for pricing on fabric over grade 7 and leather over grade 3. Additional CAL 133 information can be found on [page 15](#).

Please reference the Fabric information found on [page 17](#) for pricing on multi-upholstery.

6. Packaging

Packaging	Code	Price	
Knocked Down	KD	+ \$0	
Back Attached to Seat, Base Separate	UC	+ \$80	
Fully Assembled In a Carton	AC	+ \$200	

EFFECTIVE OCTOBER 17, 2022 | GSA SIN #: 33721

SPECIFICATIONS

	681B S1 Task Stool	681B S2 Extended Task Stool
Dimensions		
Overall Width	27"	27"
Overall Depth	27"	27"
Overall Height	41.25"-49.25"	45.25"-56.38"
Seat Width	19"	19"
Seat Depth	19"	19"
Seat Height	21.5"-29.5"	25.5"-33.5"
Back Width	19"	19"
Back Height	23"	23"
Materials		
COM	2 yd 1.7 yd (BN)	2 yd 1.7 yd (BN)
COL	34 sq ft 30 sq ft (BN)	40 sq ft 32 sq ft (BN)
Weight and Capacity		
Weight Armless	38 lb	39 lb
Weight With Arms	45 lb	46 lb
Weight Capacity Warranty	300 lb	300 lb

Ballistic nylon back (BN).



Relay

LIGHT TASK CHAIR AND STOOL

Durable and adaptable to the finish.

Great to look at, Relay™ provides lasting comfort in a stylish design that makes an appealing multipurpose seating option for meeting, training, conference and break rooms. The seat and back are molded from high-impact thermoplastic for lasting durability and comfort. Select the optional upholstered seat and back for a more sophisticated, inviting look and added comfort.



EFFECTIVE OCTOBER 17, 2022

Featured Models

GOOD :: \$534

Light task chair, plastic seat and back, basic mechanism, armless, carpet casters

BETTER :: \$642

Light task chair, upholstered seat and plastic back, swivel-tilt mechanism, armless, carpet casters, grade 1 textile



BEST :: \$758

Light task chair, upholstered seat and back, swivel-tilt mechanism, fixed cantilever arms, carpet casters, grade 1 textile

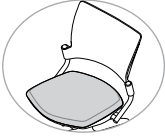

Features

- Structurally reinforced with a durable back
- High-impact polypropylene
- Fully upholstered, upholstered seat or plastic
- Nine plastic colors
- 250 lb weight capacity warranty
- Complements Relay multipurpose and nester chairs; see [page 273](#)

1. Back

Back and Seat Style	Code	Price	
Plastic	No Code	\$584	
Upholstered Seat Only	US	\$642	
Upholstered Seat and Back	UP	\$700	



2. Mechanism

Mechanism Style	Code	Price	
Basic (Swivel Only)	B	- \$50	
Swivel-Tilt	T	+ \$0	

Swivel-tilt (T) mechanism not available with task stool (S1) or extended task stool (S2).



LIGHT TASK CHAIR AND STOOL

3. Frame

Frame Type	Code	Price	
Task Chair	94T	+ \$0	
Task Stool	94T S1	+ \$132	
Extended Task Stool	94T S2	+ \$156	



4. Arms

Arm Style	Code	Price	
Armless	A0	+ \$0	
Fixed Cantilever	A60	+ \$58	

5. Base

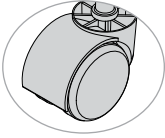
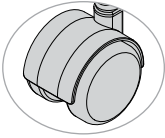
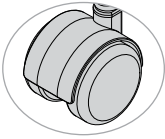
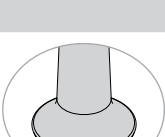
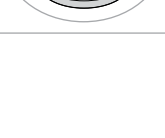
Casters or Glides	Code	Price	
Casters			
Carpet Casters	C6	+ \$0	
Hard Floor and Carpet Casters	C1	+ \$40	
Self-Locking Carpet Casters	C2	+ \$30	
Self-Locking Hard Floor and Carpet Casters	C7	+ \$61	
Glides			
Glides for Task Chairs	C3	+ \$30	

Self-locking casters lock only when not in use.

LIGHT TASK CHAIR AND STOOL

6. Material

Protection	Code	Price	
Fire Retardancy			
CAL 133, Fabric, Quantities 1–49	133F	+ \$99	
CAL 133, Fabric, Quantities 50+	133F5	+ \$55	
CAL 133, Plastic, Any Quantity	133P	+ \$45	
Shell Color	Code	Price	
Arctic	SC21	+ \$0	
Black	SC1	+ \$0	
Chocolate	SC4	+ \$0	
Lagoon	SC15	+ \$0	
Latte	SC20	+ \$0	
Navy	SC5	+ \$0	
Red	SC19	+ \$0	
Slate	SC8	+ \$0	
Sterling	SC18	+ \$0	
Textile	Code	Price	
Seat Textile (US)			
Fabric/Vinyl Grade 1	FG1/VG1	+ \$0	
COM	COM	+ \$22	
Fabric/Vinyl Grade 2	FG2/VG2	+ \$22	
Fabric/Vinyl Grade 3	FG3/VG3	+ \$45	
Fabric/Vinyl Grade 4	FG4/VG4	+ \$77	
Fabric/Vinyl Grade 5	FG5/VG5	+ \$116	
Fabric/Vinyl Grade 6	FG6/VG6	+ \$159	
Fabric/Vinyl Grade 7	FG7/VG7	+ \$200	
Seat and Back Textile (UP)			
Fabric/Vinyl Grade 1	FG1/VG1	+ \$0	
COM	COM	+ \$34	
Fabric/Vinyl Grade 2	FG2/VG2	+ \$34	
Fabric/Vinyl Grade 3	FG3/VG3	+ \$74	
Fabric/Vinyl Grade 4	FG4/VG4	+ \$121	
Fabric/Vinyl Grade 5	FG5/VG5	+ \$174	
Fabric/Vinyl Grade 6	FG6/VG6	+ \$235	
Fabric/Vinyl Grade 7	FG7/VG7	+ \$296	

Please reference the [Textile Reference Guide](#) for pricing on fabric over grade 7. Additional CAL 133 information can be found on [page 15](#).

Please reference the [Fabric information](#) found on [page 17](#) for pricing on multi-upholstery.

EFFECTIVE OCTOBER 17, 2022 | GSA SIN #: 33721

7. Packaging

Packaging	Code	Price
Back Attached to Seat, Base Separate	UC	+ \$0
Fully Assembled In a Carton	AC	+ \$120

SPECIFICATIONS

	94T Light Task Chair	94B S1 Light Task Stool	94B S2 Extended Light Task Stool
Dimensions			
Overall Width	26"	26"	26"
Overall Depth	26"	26"	26"
Overall Height	32.25"-37.25"	35.25"	39.25"
Seat Width	18.25"	20.5"	20.5"
Seat Depth	17.25"	18"	18"
Seat Height	17"-22"	20.625"-27"	23.5"-33.50"
Back Width	19.125"	19.125"	19.125"
Back Height	17"	17"	17"
Materials			
COM	0.75 yd (US) 1 yd (UP)	0.75 yd (US) 1 yd (UP)	0.75 yd (US) 1 yd (UP)
Weight and Capacity			
Weight Armless	27 lb	31 lb	32 lb
Weight With Arms	28 lb	32 lb	33 lb
Weight Capacity	250 lb	250 lb	250 lb
Warranty			

Upholstered seat (US). Upholstered seat and back (UP).



Best

Rio

LIGHT TASK CHAIR AND STOOL

Design that responds to you.

What goes into the award-winning line of Rio® plastic chairs? Patented flexing technology, for one.

Our complete family of Rio models feature our patented Active Rebound Control (ARC) Technology®—a performance-minded flexor insert that supports a wide range of motion (20 full degrees to be exact) and responds precisely to the amount of weight pressed against it.

Add a fresh, modern color palette and you've got a seating solution that allows for more movement, day-long comfort and flexibility than any other chair in its class.



EFFECTIVE OCTOBER 17, 2022

Featured Models

GOOD :: \$424

Light task chair, plastic seat and back, basic mechanism, armless, black frame, black base, carpet casters

BETTER :: \$482

Light task chair, upholstered seat and plastic back, basic mechanism, armless, black frame, black base, carpet casters, grade 1 textile



BEST :: \$633

Light task chair, upholstered seat and back, basic mechanism, fixed arms, silver frame, fog base, carpet casters, grade 1 textile

Features



- Exceptional support and comfort
- Fully upholstered, upholstered seat or plastic
- ARC Technology® for weight-assisted flex
- 14 plastic shell colors
- Two frame finishes with matching arm pads
- Easy-grip edge that acts as a pull handle
- Clean-out space
- 300 lb weight capacity warranty
- Complements Rio multipurpose chair, counter and bar stool; see [page 276](#)

1. Back

Back and Seat Style	Code	Price	
Plastic Seat and Back	PS	\$424	
Upholstered Seat Only	US	\$482	
Upholstered Seat and Back	UP	\$540	

LIGHT TASK CHAIR AND STOOL

2. Frame



Frame Type	Code	Price	
Task Chair	1052 FT3	+ \$0	
Task Stool	1052 FT3 S21	+ \$132	
Extended Task Stool	1052 FT3 S22	+ \$156	

Frame Finish	Code	Price	
Black	FC1	+ \$0	
Silver	FC2	+ \$35	

Rio task models available with basic (swivel) mechanism only.



3. Arms

Arm Style	Code	Price	
Armless	A0	+ \$0	
Fixed	A91	+ \$58	

Arms, if specified, are black for black frames and fog for silver frames.

4. Base

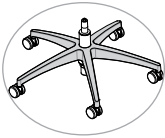
Base Color and Material	Code	Price	
Black Nylon Base (For Black Frame FC1)	B17	+ \$0	
Fog Nylon Base (For Silver Frame FC2)	B21	+ \$0	

Casters or Glides	Code	Price	
Casters			

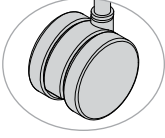
Carpet Casters	C15	+ \$0	
----------------	-----	-------	---

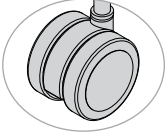
Hard Floor and Carpet Casters	C14	+ \$40	
-------------------------------	-----	--------	---

Self-Locking Carpet Casters	C20	+ \$30	
-----------------------------	-----	--------	---

Self-Locking Hard Floor and Carpet Casters	C19	+ \$64	
--	-----	--------	---

Glides

Glides for Task Chairs	C3	+ \$30	
------------------------	----	--------	---

Self-locking casters (C19/C20) lock only when chair is not in use.

LIGHT TASK CHAIR AND STOOL

5. Material

Protection	Code	Price	
Fire Retardancy			
CAL 133, Fabric, Quantities 1–49	133F	+ \$64	
CAL 133, Fabric, Quantities 50+	133F5	+ \$20	
CAL 133, Plastic, Any Quantity	133P	+ \$10	

Shell Color (For PS and US)	Code	Price	
Apple	SC24	+ \$0	
Arctic	SC21	+ \$0	
Bisque	SC7	+ \$0	
Black	SC1	+ \$0	
Chocolate	SC4	+ \$0	
Lagoon	SC15	+ \$0	
Latte	SC20	+ \$0	
Lemon	SC25	+ \$0	
Navy	SC5	+ \$0	
Pacific	SC22	+ \$0	
Red	SC19	+ \$0	
Slate	SC8	+ \$0	
Sterling	SC18	+ \$0	
Tangerine	SC23	+ \$0	

Textile	Code	Price	
Seat Textile Only (For US)			
Fabric/Vinyl Grade 1	FG1/VG1	+ \$0	
COM	COM	+ \$22	
Fabric/Vinyl Grade 2	FG2/VG2	+ \$22	
Fabric/Vinyl Grade 3	FG3/VG3	+ \$45	
Fabric/Vinyl Grade 4	FG4/VG4	+ \$77	
Fabric/Vinyl Grade 5	FG5/VG5	+ \$116	
Fabric/Vinyl Grade 6	FG6/VG6	+ \$159	
Fabric/Vinyl Grade 7	FG7/VG7	+ \$200	

Seat and Back Textile (UP)			
Fabric/Vinyl Grade 1	FG1/VG1	+ \$0	
COM	COM	+ \$34	
Fabric/Vinyl Grade 2	FG2/VG2	+ \$34	
Fabric/Vinyl Grade 3	FG3/VG3	+ \$74	
Fabric/Vinyl Grade 4	FG4/VG4	+ \$121	
Fabric/Vinyl Grade 5	FG5/VG5	+ \$174	
Fabric/Vinyl Grade 6	FG6/VG6	+ \$235	
Fabric/Vinyl Grade 7	FG7/VG7	+ \$296	

Please reference the [Textile Reference Guide](#) for pricing on fabric over grade 7. Additional CAL 133 information can be found on [page 15](#).

Please reference the [Fabric information](#) found on [page 17](#) for pricing on multi-upholstery.

EFFECTIVE OCTOBER 17, 2022 | GSA SIN #: 33721

6. Packaging

Packaging	Code	Price
Back Attached to Seat, Base Separate	UC	+ \$0
Fully Assembled in a Carton	AC	+ \$120

SPECIFICATIONS

	1052 Light Task Chair	1052 S21 Light Task Stool	1052 S22 Extended Light Task Stool
Dimensions			
Overall Width	27"	27"	27"
Overall Depth	27"	27"	27"
Overall Height	31.9"-36.9"	37.9"-45.9"	41.9"-51.9"
Seat Width	18.5"	18.5"	18.5"
Seat Depth	18.2"	18.2"	18.2"
Seat Height	16.62"-21.75"	18"-26"	23"-33"
Back Width	17.5"	17.5"	17.5"
Back Height	18.2"	18.2"	18.2"
Materials			
COM	0.85 yd (US) 1 yd (UP)	0.85 yd (US) 1 yd (UP)	0.85 yd (US) 1 yd (UP)
Weight and Capacity			
Weight Armless	20.5 lb	25.1 lb	26 lb
Weight With Arms	22.2 lb	26.8 lb	27.7 lb
Weight Capacity Warranty	300 lb	300 lb	300 lb

Upholstered seat (US). Upholstered seat and back (UP).



Best

Sona

CONFERENCE CHAIR

Meet in harmony.

Create contemporary conference rooms with the distinct style of Sona™. This up-to-any-task chair surrounds your tables with smart, sleek and slim lines while powering productivity with essential ergonomic engineering.



EFFECTIVE OCTOBER 17, 2022

Featured Models

GOOD :: \$1,078

Knit back, swivel-tilt mechanism, open loop black arms, black nylon base, carpet casters, grade 1 textile

BETTER :: \$1,171

Knit back, knee-tilt mechanism, fully adjustable black arms (6-way), black nylon base, carpet casters, grade 1 textile

BEST :: \$1,387



Upholstered back, enhanced synchro mechanism, open loop silver metallic arms, silver metallic base, silver metallic pull handle, carpet casters, grade 1 textile

Features

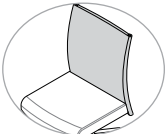

- Settle in with lumbar curve and height-adjustable back
- Add style and texture with 11 airy knit meshes
- 300 lb weight capacity warranty

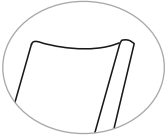
1. Back

Back Size and Style	Code	Price	
Knit Back	5723 B7	\$1,171	
Upholstered Back	5723 B8	\$1,171	



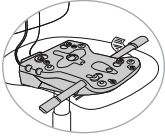
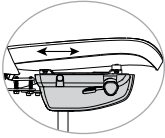

Back Options	Code	Price	
No Pull Handle	PH0	+ \$0	
Black Nylon Pull Handle	PH1	+ \$26	
Silver Metallic Pull Handle	PH2	+ \$32	

2. Mechanism



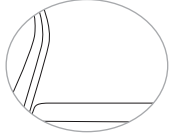

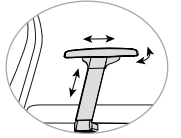
Mechanism	Code	Price	
Swivel-Tilt	T	- \$33	
Knee-Tilt	K	+ \$0	
Enhanced Synchro	Y	+ \$57	
Enhanced Synchro With Seat-Depth Adjustment	Y E3	+ \$136	

CONFERENCE CHAIR

3. Arms

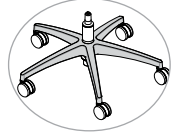
Arm Style	Code	Price	
Armless	A0	- \$135	
Black Fixed Loop	A111	- \$60	
Silver Fixed Metallic Loop	A112	+ \$14	
Fully Adjustable Black (6-Way)	AR8	+ \$0	

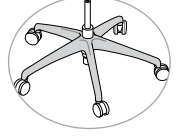
4. Base

Base Color and Material	Code	Price	
Black Nylon Base	B0	+ \$0	
Silver Metallic Base	B10	+ \$113	
Polished Aluminum Base	B3	+ \$113	
Brushed Aluminum Base	B25	+ \$113	
Low Profile Base With Higher Cylinder	S8	+ \$0	

High cylinder with low profile base (S8) is available with enhanced synchro (Y) mechanism only.

4. Base (Cont.)

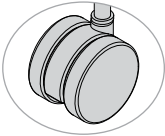
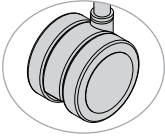
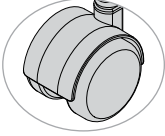
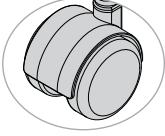
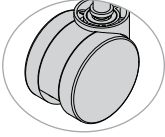
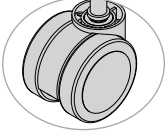
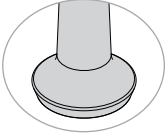
Casters or Glides	Code	Price	
Casters			
Carpet Casters	C16	+ \$0	
Hard Floor and Carpet Casters	C17	+ \$40	
Self-Locking Carpet Casters	C20	+ \$30	
Self-Locking Hard Floor and Carpet Casters	C19	+ \$64	
Casters for Low Profile Base With Higher Cylinder (S8)			
Carpet Casters	C21	+ \$0	
Hard Floor and Carpet Casters	C22	+ \$40	
Glides			
Glides for Task Chairs	C3	+ \$30	

Self-locking casters (C19/C20) lock only when chair is not in use.

5. Material

Protection	Code	Price	
Fire Retardancy			
CAL 133, Fabric, Quantities 1-49	133F	+ \$99	
CAL 133, Fabric, Quantities 50+	133F5	+ \$55	
CAL 133, Leather, Any Quantity	133L	+ \$119	

CONFERENCE CHAIR

5. Material (Cont.)

Knit Color	Code	Price	
Textured Knit			
Black	KP10	+ \$0	
Cool Gray	KP11	+ \$0	
Dune	KP13	+ \$0	
Forest	KP14	+ \$0	
Merlot	KP16	+ \$0	
Mocha	KP12	+ \$0	
Ocean	KP15	+ \$0	
Twin Knit			
Licorice	KP23	+ \$0	
Shadow	KP22	+ \$0	
Toffee	KP20	+ \$0	
Winter Gray	KP21	+ \$0	



Better

5. Material (Cont.)

Textile (For Both B7 and B8)	Code	Price
Fabric/Vinyl Grade 1	FG1/VG1	+ \$0
COM	COM	+ \$34
Fabric/Vinyl Grade 2	FG2/VG2	+ \$34
Fabric/Vinyl Grade 3	FG3/VG3	+ \$74
Fabric/Vinyl Grade 4	FG4/VG4	+ \$121
Fabric/Vinyl Grade 5	FG5/VG5	+ \$174
Fabric/Vinyl Grade 6	FG6/VG6	+ \$235
Fabric/Vinyl Grade 7	FG7/VG7	+ \$296
Leather Grade 1	LG1	+ \$260
COL	COL	+ \$320
Leather Grade 2	LG2	+ \$320
Leather Grade 3	LG3	+ \$400

Please reference the [Textile Reference Guide](#) for pricing on fabric over grade 7 and leather over grade 3. Additional CAL 133 information can be found on [page 15](#).
Please reference the [Fabric information](#) found on [page 17](#) for pricing on multi-upholstery.



Good

CONFERENCE CHAIR

6. Packaging

Packaging	Code	Price
Knocked Down	KD	+ \$0
Back Attached to Seat, Base Separate	UC	+ \$80
Fully Assembled in a Carton	AC	+ \$200

SPECIFICATIONS

5723 Conference Chair	
Dimensions	
Overall Width	27"
Overall Depth	25"
Overall Height	37"-43.5"
Seat Width	19"
Seat Depth	18"
Seat Height	17.5"-20.5"
Back Width	19"
Back Height	25"
Materials	
COM	1 yd (B7) 1.75 yd (B8)
COL	17 sq ft (B7) 32 sq ft (B8)
Weight and Capacity	
Weight Armless	46 lb
Weight With Arms	52 lb
Weight Capacity Warranty	300 lb

Knit back (B7). Upholstered back (B8).

Torsa

TASK CHAIR

Inspired by nature.

Cutting-edge design and the ability to personalize frame, arm, and mesh color combinations make Torsa™ the natural preference for a fresh, clean style. The innovative cable-driven synchro mechanism with Comfort Drive® allows easy fingertip adjustment from a seated position. And remarkably, excellent ergonomics come standard with adjustable lumbar support and seat-depth adjustment.



EFFECTIVE OCTOBER 17, 2022

Featured Models

GOOD :: \$995

Enhanced synchro mechanism with Comfort Drive and seat-depth adjustment, fixed nylon arms, nylon base, carpet casters, grade 1 textile

BETTER :: 1,035

Enhanced synchro mechanism with Comfort Drive and seat-depth adjustment, multi-adjustable nylon arms, nylon base, carpet casters, grade 1 textile

BEST :: \$1,201

Enhanced synchro mechanism with Comfort Drive and seat-depth adjustment, fixed polished aluminum arms, polished aluminum base, carpet casters, grade 1 textile

Features

- Cutting-edge design
- Comfortable and durable mesh back
- 10 bleach-cleanable mesh colors
- Four frame/arm/back support color combinations
- Enhanced synchro with Comfort Drive and seat-depth adjustment
- Adjustable lumbar support
- Textured control knobs
- Waterfall seat

1. Back

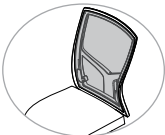
Back Size and Style	Code	Price	
Highback Mesh	6023	\$1,035	

2. Mechanism

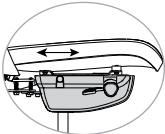
Mechanism Style	Code	Price	
Enhanced Synchro With Comfort Drive and Seat-Depth Adjustment	Y E3	+ \$0	

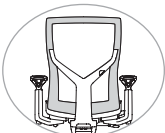
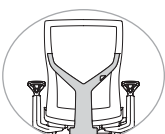

Seat-depth adjustment available with enhanced synchro (Y) mechanism only.

3. Frame

Frame Color	Code	Price	
Graphite	FC11	+ \$0	
White	FC12	+ \$0	
Back Support Color	Code	Price	
Graphite	Z3	+ \$0	
White	Z4	+ \$0	

TASK CHAIR

4. Arms

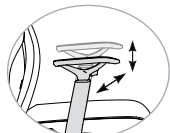
Arm Style	Code	Price	
Armless	A0	- \$78	
Fixed Nylon	A132	- \$40	
Fixed Polished Aluminum	A131	+ \$53	
Multi-Adjustable (Height/Width)	A134	+ \$0	

Arm color will match back support color. Fixed polished aluminum arms available with either back support color.

5. Base

Base Color and Material	Code	Price	
Graphite Nylon Base (For Graphite Frame C11)	B14	+ \$0	
White Nylon Base (For White Frame FC12)	B20	+ \$0	
Polished Aluminum Base	B16	+ \$113	

Nylon bases must pair with their corresponding frame color. Polished aluminum base (B16) can be used with either frame color.

5. Base (Cont.)

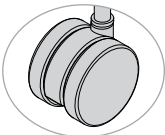
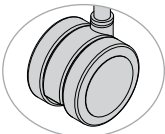
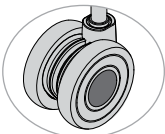
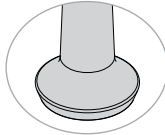
Casters or Glides	Code	Price	
Casters			
Carpet Casters	C25	+ \$0	
Hard Floor and Carpet Casters	C26	+ \$40	
Designer Casters	C30	+ \$119	
Glides			
Glides for Task Chairs	C3	+ \$30	



TASK CHAIR

5. Base (Cont.)

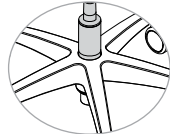
Cylinder Height	Code	Price	
Standard Cylinder	No Code	+ \$0	
Higher Cylinder	S13	+ \$0	

6. Material

Protection	Code	Price	
Fire Retardancy			
CAL 133, Fabric, Quantities 1-49	133F	+ \$99	
CAL 133, Fabric, Quantities 50+	133F5	+ \$55	
CAL 133, Leather, Any Quantity	133L	+ \$119	
Mesh Color	Code	Price	
Desert Solid Mesh	MC9	+ \$0	
Desert Striped Mesh	MC16	+ \$0	
Electric Blue Solid Mesh	MC13	+ \$0	
Fire Solid Mesh	MC10	+ \$0	
Fog Solid Mesh	MC7	+ \$0	
Fog Striped Mesh	MC15	+ \$0	
Navy Solid Mesh	MC8	+ \$0	
Nickel Solid Mesh	MC6	+ \$0	
Onyx Solid Mesh	MC5	+ \$0	
Onyx Striped Mesh	MC14	+ \$0	
Seat Textile	Code	Price	
Fabric/Vinyl Grade 1	FG1/VG1	+ \$0	
COM	COM	+ \$26	
Fabric/Vinyl Grade 2	FG2/VG2	+ \$26	
Fabric/Vinyl Grade 3	FG3/VG3	+ \$60	
Fabric/Vinyl Grade 4	FG4/VG4	+ \$116	
Fabric/Vinyl Grade 5	FG5/VG5	+ \$172	
Fabric/Vinyl Grade 6	FG6/VG6	+ \$213	
Fabric/Vinyl Grade 7	FG7/VG7	+ \$254	
Leather Grade 1	LG1	+ \$300	
COL	COL	+ \$380	
Leather Grade 2	LG2	+ \$380	
Leather Grade 3	LG3	+ \$480	

Please reference the [Textile Reference Guide](#) for pricing on fabric over grade 7 and leather over grade 3.

EFFECTIVE OCTOBER 17, 2022 | GSA SIN #: 33721

7. Packaging

Packaging	Code	Price
Knocked Down	KD	+ \$0
Back Attached to Seat, Base Separate	UC	+ \$80
Fully Assembled in a Carton	AC	+ \$200

SPECIFICATIONS

6023 Highback Mesh Task Chair	
Dimensions	
Overall Width Armless	26"
Overall Width With Arms	27"
Overall Depth	27.125"
Overall Height	44.5"
Seat Width	19"
Seat Depth	18"-20.25"
Seat Height	17.36"-21.75" 19"-23.75" (S13)
Back Width	19"
Back Height	22"
Materials	
COM	1 yd
COL	17 sq ft
Weight and Capacity	
Weight Armless	45 lb
Weight With Arms	50 lb
Weight Capacity Warranty	300 lb

Higher cylinder (S13).



TR2

TASK AND EXECUTIVE CHAIR

Ergonomics at work.

Classic ergonomic design and lifetime durability make the TR2™ a reliable task/executive chair. Six control and comfort mechanisms plus five arm options mean this chair is more versatile and comfortable than any other chair in its price range.



Best

EFFECTIVE OCTOBER 17, 2022

Featured Models

GOOD :: \$888

Midback task, swivel-tilt mechanism, height-adjustable arms, black nylon base, carpet casters, grade 1 textile

BETTER :: \$1,014

Midback task, multi-function mechanism, height-adjustable arms, black nylon base, carpet casters, grade 1 textile

BEST :: \$1,103

Midback task, enhanced synchro mechanism with seat-depth adjustment, height-/width-adjustable arms with pivot, black nylon base, carpet casters, grade 1 textile

Features



- Internal back-height adjustment
- Five control mechanisms for motion and comfort
- Optional seat-depth adjustment
- Waterfall seat promotes proper leg circulation
- Five arm styles
- Molded foam seat cushion
- CAL 133 approved models
- 300 lb weight capacity warranty;
350 lb Heavy Duty 24/7 weight capacity warranty

1. Back

Back Size and Style	Code	Price	
Midback Task	40	\$1,014	

Highback Executive	40E	\$1,089	
--------------------	-----	---------	---

Back Options	Code	Price	
Upholstered Back	N	+ \$0	

Plastic Back for Task	E4	+ \$0	
Plastic Back for Executive	E5	+ \$0	

Plastic back (E4/E5) requires posture back (P) or multi-function (M) mechanism.

2. Super Duty

Super Duty Series	Code	Price	
Heavy Duty	HD	+ \$126	

Available with enhanced synchro (Y) or multi-function (M) mechanism only. See the Super Duty Guide on page 591 for additional LT and HD options.

TASK AND EXECUTIVE CHAIR

3. Seat

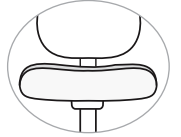
Seat Options	Code	Price	
1" Additional Foam	F1	+ \$36	

4. Mechanism

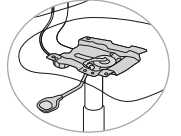
Mechanism Style	Code	Price	
Basic (Swivel Only)	B	- \$169	

Swivel-Tilt	T	- \$126	
-------------	---	---------	---

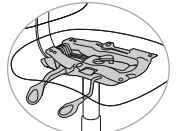
Posture Back	P	- \$54	
--------------	---	--------	--

Enhanced Synchro	Y	- \$36	
------------------	---	--------	---

Multi-Function	M	+ \$0	
----------------	---	-------	---

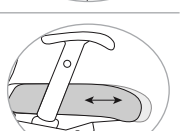
Posture Back With Seat-Depth Adjustment	P E3	+ \$25	
---	------	--------	---

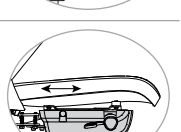
Enhanced Synchro Seat-Depth Adjustment	Y E3	+ \$43	
--	------	--------	---

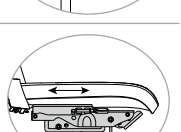

Multi-Function With Seat-Depth Adjustment	M E3	+ \$79	
---	------	--------	---

Basic mechanism (B) not available on highback executive model (40E).

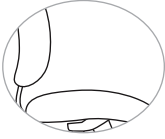
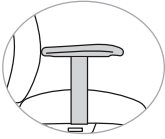
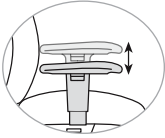
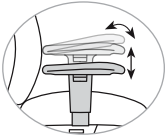
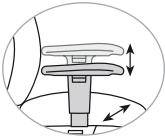
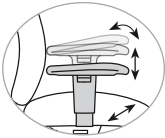
5. Arms

Arm Style	Code	Price	
Armless	A0	- \$110	
Fixed Pad	A12	- \$35	
Height-Adjustable	A15	+ \$0	
Height-Adjustable With Pivot	A43	+ \$10	
Height-/Width-Adjustable	A17	+ \$36	
Height-/Width-Adjustable With Pivot	A44	+ \$46	

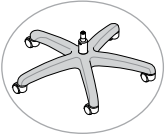
6. Base

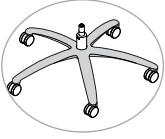
Base Color and Material	Code	Price	
Black Nylon Base	B0	+ \$0	
Heavy Duty Black Nylon Base, 26"	B7	+ \$0	
Brushed Aluminum Base	B2	+ \$113	

TASK AND EXECUTIVE CHAIR

6. Base (Cont.)

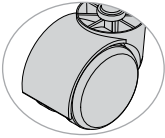
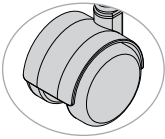
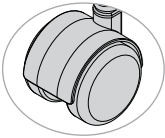
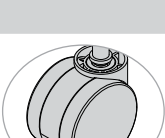
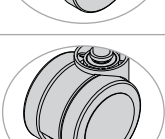
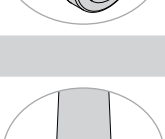
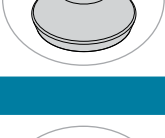
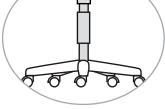
Casters or Glides	Code	Price	
Casters (For Black Base Only)			
Carpet Casters	C5	+ \$0	
Hard Floor and Carpet Casters	C1	+ \$40	
Self-Locking Carpet Casters	C2	+ \$30	
Self-Locking Hard Floor and Carpet Casters	C7	+ \$61	
Heavy Duty Casters			
Heavy Duty Carpet Casters	C11	+ \$0	
Heavy Duty Hard Floor and Carpet Casters	C9	+ \$61	
Glides			
Glides for Task Chairs	C3	+ \$30	
Cylinder Height	Code	Price	
Cylinder Extension Kit	S3	+ \$89	

*Glides (C3) are for black base only. Self-locking casters (C2/C7) lock only when chair is not in use.
Cylinder extension kit (S3) is only available with basic (B) or posture back (P) mechanisms.*

EFFECTIVE OCTOBER 17, 2022 | GSA SIN #: 33721

7. Material

Protection	Code	Price
Fire Retardancy		
CAL 133, Fabric, Quantities 1–49	133F	+ \$99
CAL 133, Fabric, Quantities 50+	133F5	+ \$55
Ballistic Nylon Back	Code	Price
Ballistic Nylon Back	BN	+ \$0
Seat and Back Textile	Code	Price
Fabric/Vinyl Grade 1	FG1/VG1	+ \$0
COM	COM	+ \$34
Fabric/Vinyl Grade 2	FG2/VG2	+ \$34
Fabric/Vinyl Grade 3	FG3/VG3	+ \$74
Fabric/Vinyl Grade 4	FG4/VG4	+ \$121
Fabric/Vinyl Grade 5	FG5/VG5	+ \$174
Fabric/Vinyl Grade 6	FG6/VG6	+ \$235
Fabric/Vinyl Grade 7	FG7/VG7	+ \$296
Leather Grade 1	LG1	+ \$340
COL	COL	+ \$460
Leather Grade 2	LG2	+ \$460
Leather Grade 3	LG3	+ \$600

Please reference the [Textile Reference Guide](#) for pricing on fabric over grade 7 and leather over grade 3.

Please reference the [Fabric information found on page 17](#) for pricing on multi-upholstery.

8. Packaging

Packaging	Code	Price
Knocked Down	KD	+ \$0
Back Attached to Seat, Base Separate	UC	+ \$80
Fully Assembled in a Carton	AC	+ \$200

SPECIFICATIONS

	40 Midback Task	40E Highback Executive
Dimensions		
Overall Width	26"	26"
Overall Depth	26"	26"
Overall Height	36"	40.5"
Seat Width	20"	21"
Seat Depth	18"	20"
Seat Height	16.5"–21"	16.5"–21"
Back Width	18"	20"
Back Height	19.5"	24"
Materials		
COM	1.5 yd 1.25 yd (BN)	2 yd 1.7 yd (BN)
COL	25 sq ft 20 sq ft (BN)	36 sq ft 30 sq ft (BN)
Weight and Capacity		
Weight Armless	38 lb (B)	N/A (B)
	41 lb (T)	44 lb (T)
	42 lb (P)	45 lb (P)
	45 lb (Y)	45 lb (Y)
	48 lb (M)	51 lb (M)
Weight With Arms	43 lb (B)	N/A (B)
	46 lb (T)	49 lb (T)
	47 lb (P)	50 lb (P)
	50 lb (Y)	50 lb (Y)
	47 lb (M)	56 lb (M)
Weight Capacity Warranty	300 lb	300 lb
	350 lb (Y/M) (HD)	350 lb (Y/M) (HD)

Basic mechanism (B). Swivel-tilt mechanism (T). Posture back mechanism (P). Enhanced synchro mechanism (Y). Multi-function mechanism (M). Ballistic nylon back (BN).

TR2

TASK STOOL

Ergonomics at work.

The efficient, modest lines of the TR2 collection mimic the state of business: robust, reliable and not wasting a single step. Two control and comfort mechanisms plus five arm options create a multitude of customization opportunities that make this classic task stool more versatile and comfortable than any other in its price range.



EFFECTIVE OCTOBER 17, 2022

Featured Models

GOOD :: \$838

Midback stool, basic mechanism, armless, standard stool kit, black nylon base, carpet casters, grade 1 textile

BETTER :: \$948

Midback stool, basic mechanism, height-adjustable arms, standard stool kit, black nylon base, carpet casters, grade 1 textile

BEST :: \$1,123

Midback stool, posture back mechanism, height-/width-adjustable arms, extended stool kit, black nylon base, carpet casters, grade 1 textile

Features

- Two control mechanisms for motion and comfort
- Waterfall seat
- Five arm styles
- Molded foam seat cushion
- 300 lb weight capacity warranty;
350 lb Heavy Duty 24/7 weight capacity warranty

1. Back

Back Size and Style	Code	Price	
Midback Task	40	\$1,063	

Back Options	Code	Price	
Upholstered Back	N	+ \$0	

Plastic Back for Task	E4	+ \$0	
-----------------------	----	-------	---

Plastic back (E4) requires posture back (P) mechanism.

2. Seat

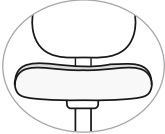
Seat Options	Code	Price	
1" Additional Foam	F1	+ \$36	



3. Heavy Duty

Heavy Duty Series	Code	Price	
Heavy Duty	HD	+ \$191	

Heavy Duty mechanism (HD) requires heavy duty stool kit (S1HD/S2HD) and heavy duty basic mechanism.

TASK STOOL

4. Mechanism

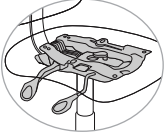
Mechanism Style	Code	Price	
Basic (Swivel Only)	B	- \$115	
Heavy Duty Basic (Swivel Only)	B2	+ \$0	
Posture Back	P	+ \$0	

Heavy duty basic mechanism (B2) is only available on heavy duty (HD) models.



5. Arms

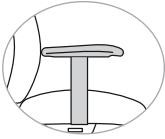
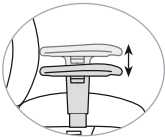
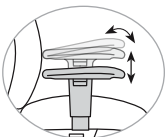
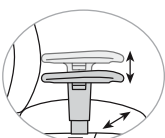
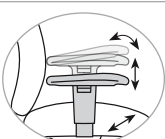

Arm Style	Code	Price	
Armless	A0	- \$110	
Fixed Pad	A12	- \$35	
Height-Adjustable	A15	+ \$0	
Height-Adjustable With Pivot	A43	+ \$10	
Height-/Width-Adjustable	A17	+ \$36	
Height-/Width-Adjustable With Pivot	A44	+ \$46	

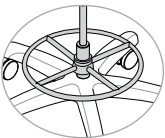
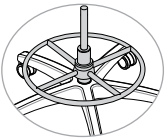
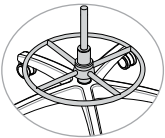
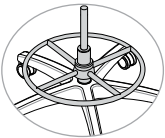
6. Base

Base	Code	Price	
Standard Stool Kit	S1	+ \$0	
Extended Stool Kit	S2	+ \$24	
Heavy Duty Stool Kit	S1HD	+ \$0	
Heavy Duty Extended Stool Kit	S2HD	+ \$24	

TASK STOOL

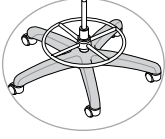
6. Base (Cont.)

Base Color and Material	Code	Price	
Black Nylon Base	B0	+ \$0	
Brushed Aluminum Base	B2	+ \$113	

Casters or Glides	Code	Price	
Casters (For Black Base Only)			

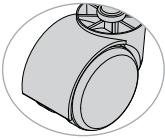
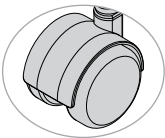
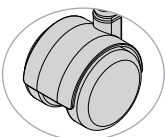
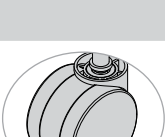
Black Carpet Casters	C5	+ \$0	
Hard Floor and Carpet Casters	C1	+ \$40	
Self-Locking Carpet Casters	C2	+ \$30	
Self-Locking Hard Floor and Carpet Casters	C7	+ \$61	

Heavy Duty Casters			
---------------------------	--	--	--

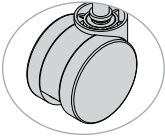
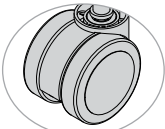
Heavy Duty Carpet Casters	C11	+ \$0	
Heavy Duty Hard Floor and Carpet Casters	C9	+ \$61	

Glides			
---------------	--	--	--

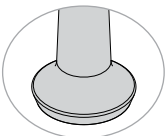
Glides for Task Chairs	C3	+ \$30	
------------------------	----	--------	---

Self-locking casters (C2/C7) lock only when chair is not in use.

7. Material

Protection	Code	Price
Fire Retardancy		
CAL 133, Fabric, Quantities 1–49	133F	+ \$99
CAL 133, Fabric, Quantities 50+	133F5	+ \$55
CAL 133, Leather, Any Quantity	133L	+ \$119
Ballistic Nylon	Code	Price
Ballistic Nylon Back	BN	+ \$0
Seat and Back Textile	Code	Price
Fabric/Vinyl Grade 1	FG1/VG1	+ \$0
COM	COM	+ \$34
Fabric/Vinyl Grade 2	FG2/VG2	+ \$34
Fabric/Vinyl Grade 3	FG3/VG3	+ \$74
Fabric/Vinyl Grade 4	FG4/VG4	+ \$121
Fabric/Vinyl Grade 5	FG5/VG5	+ \$174
Fabric/Vinyl Grade 6	FG6/VG6	+ \$235
Fabric/Vinyl Grade 7	FG7/VG7	+ \$296
Leather Grade 1	LG1	+ \$340
COL	COL	+ \$460
Leather Grade 2	LG2	+ \$460
Leather Grade 3	LG3	+ \$600

Please reference the [Textile Reference Guide](#) for pricing on fabric over grade 7 and leather over grade 3. Additional CAL 133 information can be found on [page 15](#).

Please reference the [Fabric information](#) found on [page 17](#) for pricing on multi-upholstery.

8. Packaging

Packaging	Code	Price
Knocked Down	KD	+ \$0
Back Attached to Seat, Base Separate	UC	+ \$80
Fully Assembled in a Carton	AC	+ \$200

SPECIFICATIONS

	40 S1 Task Stool	40 S2 Extended Task Stool
Dimensions		
Overall Width	27"	27"
Overall Depth	27"	27"
Overall Height	39"	43"
Seat Width	20"	20"
Seat Depth	19" 18" (HD)	18" 18" (HD)
Seat Height	19"–27" (B) 19.5"–27.5" (P)	23"–33" (B) 23.5"–33.5" (P)
Back Width	18"	18"
Back Height	21"	21"
Materials		
COM	1.5 yd 1.25 yd (BN)	1.5 yd 1.25 yd (BN)
COL	25 sq ft 20 sq ft (BN)	25 sq ft 20 sq ft (BN)
Weight and Capacity		
Weight Armless	42 lb (B) 45 lb (P) 43 lb (B2)(HD)	43 lb 43 lb (B2)(HD)
Weight With Arms	45 lb (B) 50 lb (P) 48 lb (B2) (HD)	48 lb 48 lb (B2) (HD)
Weight Capacity Warranty	300 lb 350 lb (HD)	300 lb 350 lb (HD)

Heavy Duty model (HD). Basic mechanism (B). Posture back mechanism (P). Heavy Duty mechanism (B2). Ballistic nylon back (BN).

Vectra

MESH BACK TASK CHAIR

Experience beyond.

Meet our most advanced product yet. Vectra™ is next-gen intelligent design with smart features promising smarter solutions. It's a super-slim, precision-engineered package built to deliver robust on-demand comfort and the kind of cutting-edge innovation that redefines an entire category.



EFFECTIVE OCTOBER 17, 2022

Featured Models

GOOD :: \$854

Highback mesh with adjustable lumbar, enhanced synchro mechanism, graphite frame, height-adjustable arms, graphite nylon base, carpet casters, grade 1 textile

BETTER :: \$947

Highback mesh with adjustable lumbar, advanced synchro mechanism with seat-depth adjustment, graphite frame, height-adjustable arms, graphite nylon base, carpet casters, grade 1 textile

BEST :: \$1,042

Highback mesh with adjustable lumbar, advanced synchro mechanism with seat-depth adjustment, fog frame, fully adjustable (8-way) arms, fog nylon base, carpet casters, grade 1 textile

Features

- Activate proprietary lumbar tension and support with quick-adjust slide knobs
- Five tilt-limiter back positions for comfort in various activities
- Seat tension adjusts quickly in less than two revolutions
- Match performance casters and base to three different frame colors
- Six colors of ultra-sheer micro mesh
- Customizable arm triggers, caster rings and lumbar adjustment carriage with 13 accent colors
- Energizing ergonomics
- Aerodynamic flair with low-profile arms and slim graphite arm pads

1. Back

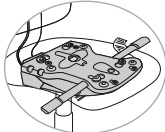
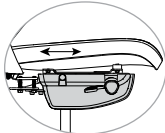
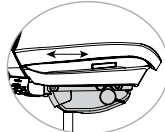

Back Size and Style	Code	Price	
Highback Mesh With Adjustable Lumbar Support	1073 BK2 MB	\$947	

2. Mechanism

Mechanism Style	Code	Price	
Enhanced Synchro	Y	- \$93	
Enhanced Synchro With Seat-Depth Adjustment	Y/E3	- \$54	
Advanced Synchro With Seat-Depth Adjustment	L/E3	+ \$0	



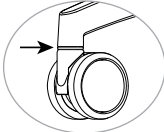

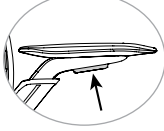
MESH BACK TASK CHAIR

3. Frame

Frame Color	Code	Price	
Graphite	FC11	+\$0	
White	FC12	+\$35	
Fog	FC13	+\$35	
Accent Color	Code	Price	
Apple	LA12	+ \$0	
Desert	LA3	+ \$0	
Electric Blue	LA5	+ \$0	
Fire	LA6	+ \$0	
Fog	LA4	+ \$0	
Graphite	LA14	+ \$0	
Lemon	LA8	+ \$0	
Navy	LA15	+ \$0	
Nickel	LA2	+ \$0	
Onyx	LA1	+ \$0	
Platinum	LA16	+ \$0	
Tangerine	LA9	+ \$0	
White	LA13	+ \$0	

Accent color applies to lumbar adjustment, arm adjustment buttons and caster rings.

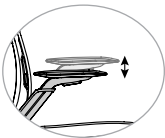
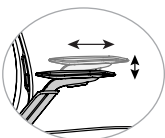
4. Arms

Arm Style	Code	Price	
Armless	AR0	- \$48	
Fixed Arms	AR2	- \$10	
Height-Adjustable	AR4	+ \$0	
Height-/Width-Adjustable	AR6	+ 30	
Fully Adjustable (8-Way)	AR9	+ \$60	

5. Base

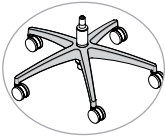
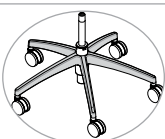
Base Color and Material	Code	Price	
Graphite Nylon Base (For Graphite Frame FC11)	B14	+ \$0	
Fog Nylon Base (For Fog Frame FC13)	B21	+ \$0	
White Nylon Base (For White Frame FC12)	B20	+ \$0	
Polished Aluminum Base	B18	+ \$113	

Nylon base color must match frame color. Aluminum base (B18) can be used with any frame color. Polished aluminum base (B18) is not available with lower cylinder (CH4).

MESH BACK TASK CHAIR

5. Base (Cont.)

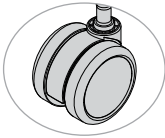
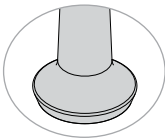
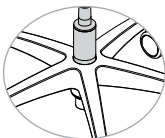
Casters or Glides	Code	Price	
Casters			
Carpet Casters	CS5	+ \$0	
Hard Floor and Carpet Casters	CS6	+ \$40	
Glides			
Glides for Task Chairs	CS3	+ \$30	
Cylinder Height			
Standard Cylinder	CH1	+ \$0	
Higher Cylinder	CH3	+ \$0	
Lower Cylinder	CH4	+ \$0	

Caster color coordinates with frame color. Lower cylinder (CH4) is not available with polished aluminum base (B18).

6. Material

Mesh Color	Code	Price	
Desert	MC9	+ \$0	
Mist	MC41	+ \$0	
Navy	MC8	+ \$0	
Nickel	MC6	+ \$0	
Onyx	MC5	+ \$0	
Platinum	MC42	+ \$0	
Seat Textile			
Fabric/Vinyl Grade 1	FG1/VG1	+ \$0	
COM	COM	+ \$26	
Fabric/Vinyl Grade 2	FG2/VG2	+ \$26	
Fabric/Vinyl Grade 3	FG3/VG3	+ \$60	
Fabric/Vinyl Grade 4	FG4/VG4	+ \$116	
Fabric/Vinyl Grade 5	FG5/VG5	+ \$172	
Fabric/Vinyl Grade 6	FG6/VG6	+ \$213	
Fabric/Vinyl Grade 7	FG7/VG7	+ \$254	
Leather Grade 1	LG1	+ \$300	
COL	COL	+ \$380	
Leather Grade 2	LG2	+ \$380	
Leather Grade 3	LG3	+ \$480	

Please reference the [Textile Reference Guide](#) for pricing on fabric over grade 7 and leather over grade 3.

EFFECTIVE OCTOBER 17, 2022 | GSA SIN #: 33721

7. Packaging

Packaging	Code	Price
Knocked Down	KD	+ \$0
Back Attached to Seat, Base Separate	UC	+ \$80
Fully Assembled in a Carton	AC	+ \$200

SPECIFICATIONS

1073.BK2.MB Highback Mesh Task Chair	
Dimensions	
Overall Width Armless	26"
Overall Width With Arms	27"
Overall Depth	25"
Overall Height	38" (L/E3), 38.5" (Y/E3)
Seat Width	19.75"
Seat Depth	17"
Seat Height Short Cylinder	15.5"–17.63" (L/E3) 16"–18.1" (Y/E3)
Seat Height Standard Cylinder	16.5"–20.75" 17"–21.25" (Y/E3)
Seat Height High Cylinder	18.25"–22.63" (L/E3), 18.75"–23.1" (Y/E3)
Back Width	20.5"
Back Height	23"
Materials	
COM	1.1 yd
COL	20 sq ft
Weight and Capacity	
Weight Armless	30 lb
Weight With Arms	33 lb (L/E3), 41 lb (Y/E3)
Weight Capacity Warranty	300 lb

Enhanced synchro with seat-depth Adjustment (Y/E3). Advanced synchro with seat-depth adjustment (L/E3)



Wit

MESH BACK TASK CHAIR

Work smarter.

Gone are the days where you clock in, stay in your cubicle and clock out.

Dynamic environments call for adaptable seating that rolls with the punches. Our Wit™ family does exactly that. Because this is a design inspired by truths about how people work.

Today's ever-changing marketplace calls for flexibility. Teams need to be able to set up shop anywhere—and at any time. All of our Wit task models are easily adjustable so anyone can find a seat, settle in and get right to work.



EFFECTIVE OCTOBER 17, 2022

Featured Models

GOOD :: \$628

Midback, swivel-tilt mechanism, height-adjustable arms, black frame, black nylon base, carpet casters, grade 1 textile

BETTER :: \$674

Highback, standard synchro mechanism, height-adjustable arms, black frame, black nylon base, carpet casters, grade 1 textile

BEST :: \$828

Highback, standard synchro mechanism with seat-depth adjustment, multi-adjustable arms, white frame, white nylon base, carpet casters, grade 1 textile

Features

- Midback and highback task chairs
- Standard adjustable lumbar support
- Built-in pull handle
- 12 solid mesh back colors
- Four woven striped mesh options
- Three frame colors
- Standard synchro, swivel-tilt and basic mechanisms
- Multi-adjustable (height/width), height-adjustable, armless and fixed arms
- Textured designer arms
- Optional seat-depth adjustment
- Optional brushed aluminum base
- Waterfall seat
- Standard 300 lb weight capacity warranty
- Complemented by Wit Side; see [page 286](#)

1. Back

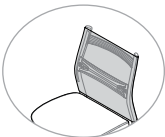
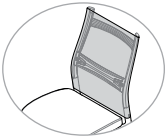
Back Size and Style	Code	Price	
Midback Mesh With Adjustable Lumbar Support	2222 B1	\$646	
Highback Mesh With Adjustable Lumbar Support	2223 B1	\$674	

MESH BACK TASK CHAIR

2. Mechanism

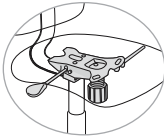
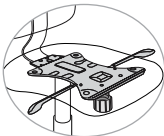
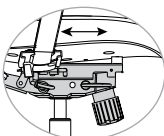
Mechanism Style	Code	Price	
Basic (Swivel Only)	B	- \$33	
Swivel-Tilt	T	- \$18	
Standard Synchro	F	+ \$0	
Standard Synchro With Seat-Depth Adjustment	F E3	+ \$79	

3. Frame

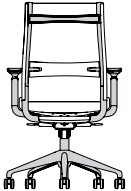
Frame Color	Code	Price	
Black	FC1	+ \$0	
White	FC12	+ \$45	
Fog	FC13	+ \$45	

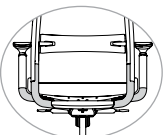

Back Support Color	Code	Price	
Black (For Black Frame FC1)	Z1	+ \$0	
Silver (For Black Frame FC1)	Z2	+ \$0	
White (For White Frame FC12)	Z4	+ \$0	
Fog (For Fog Frame FC13)	Z7	+ \$0	

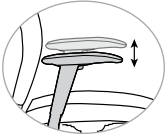
4. Arms

Arm Style	Code	Price	
Armless	A0	- \$48	
Fixed	A127	- \$10	
Height-Adjustable	A128	+ \$0	
Multi-Adjustable (Height/Width)	A129	+ \$30	

Arms, if specified, come with fog arm pads for the white and fog frames and black arm pads for the black frame.

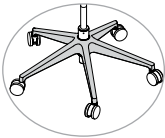
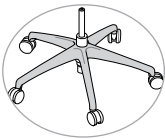
5. Base

Base Color and Material	Code	Price	
Black Nylon Base With Black Casters (For Black Frame FC1)	B0	+ \$0	
White Nylon Base With Fog/White Casters (For White Frame FC12)	B20	+ \$0	
Fog Nylon Base With Fog Casters (For Fog Frame FC13)	B21	+ \$0	
Brushed Aluminum Base	B8	+ \$113	
Heavy Duty Black Base, 26"	B7	+ \$0	

Heavy duty black base (B7) requires lower cylinder. Brushed aluminum base (B8) can be used with any frame color.

Chairs configured with the brushed aluminum base (B8) and standard synchro (F) mechanism with the High cylinder (S13)

MESH BACK TASK CHAIR

5. Base (Cont.)

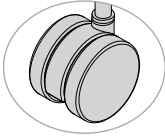
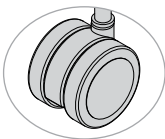
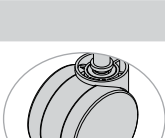
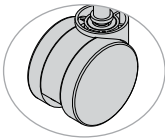
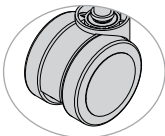
Casters or Glides	Code	Price	
Casters			
Black Carpet Casters (for Black Frame – FC1)	C16	+ \$0	
Black Hard Floor and Carpet Casters (For Black Frame FC1)	C17	+ \$40	
Hard Floor and Carpet Casters (For Fog or White Frame FC12/FC13)	CS6	+ \$0	
Heavy Duty Casters			
Heavy Duty Carpet Casters	C11	+ \$0	
Heavy Duty Hard Floor and Carpet Casters	C9	+ \$61	

Glides

Glides for Task Chairs	C3	+ \$30	
------------------------	----	--------	---

Cylinder Height	Code	Price	
Standard Cylinder	S0	+ \$0	
Higher Cylinder	S13	+ \$0	
Lower Cylinder	S10	+ \$0	

Lower cylinder (S10) is available for Heavy Duty (HD) model only. Higher cylinder (S13) is required on chairs configured with the brushed aluminum base (B8) and standard synchro (F) mechanism.

6. Material

Protection	Code	Price	
Fire Retardancy			
CAL 133, Fabric, Quantities 1–49	133F	+ \$99	
CAL 133, Fabric, Quantities 50+	133F5	+ \$55	
CAL 133, Leather, Any Quantity	133L	+ \$119	

EFFECTIVE OCTOBER 17, 2022 | GSA SIN #: 33721

6. Material (Cont.)

Mesh Color	Code	Price
Solid Mesh		
Apple	MC31	+ \$0
Aqua	MC30	+ \$0
Desert	MC22	+ \$0
Electric Blue	MC24	+ \$0
Fire	MC25	+ \$0
Fog	MC23	+ \$0
Grape	MC26	+ \$0
Lemon	MC27	+ \$0
Nickel	MC21	+ \$0
Ocean	MC29	+ \$0
Onyx	MC20	+ \$0
Tangerine	MC28	+ \$0
Woven Striped Mesh		
Fog	MC37	+ \$0
Frost	MC36	+ \$0
Nickel	MC38	+ \$0
Onyx	MC35	+ \$0
Seat Textile	Code	Price
Fabric/Vinyl Grade 1	FG1/VG1	+ \$0
COM	COM	+ \$26
Fabric/Vinyl Grade 2	FG2/VG2	+ \$26
Fabric/Vinyl Grade 3	FG3/VG3	+ \$60
Fabric/Vinyl Grade 4	FG4/VG4	+ \$116
Fabric/Vinyl Grade 5	FG5/VG5	+ \$172
Fabric/Vinyl Grade 6	FG6/VG6	+ \$213
Fabric/Vinyl Grade 7	FG7/VG7	+ \$254
Leather Grade 1	LG1	+ \$300
COL	COL	+ \$380
Leather Grade 2	LG2	+ \$380
Leather Grade 3	LG3	+ \$480

Please reference the [Textile Reference Guide](#) for pricing on fabric over grade 7 and leather over grade 3. Additional CAL 133 information can be found on [page 15](#).

7. Packaging

Packaging	Code	Price
Knocked Down	KD	+ \$0
Back Attached to Seat, Base Separate	UC	+ \$80
Fully Assembled in a Carton	AC	+ \$200

SPECIFICATIONS

	2222 B1 Midback Mesh Task Chair	2223 B1 Highback Mesh Task Chair
Dimensions		
Overall Width Armless	25"	25"
Overall Width With Arms	26"	26"
Overall Depth	25"	25"
Overall Height	36.75"	40.75"
Seat Width	20"	20"
Seat Depth	17.5"-19.5"	17.5"-19.5"
Seat Height	17.5"-21.25" (F/T) 16.63"-20.38" (B) 17.75"-21.5" (F/E3)	17.5"-21.25" (F/T) 16.63"-20.38" (B) 17.75"-21.5" (F/E3)
Seat Height With Higher Cylinder	19"-22.5" (F/T) 18"-21.5" (B) 19"-22.5" (F/E3)	19"-22.5" (F/T) 18"-21.5" (B) 19"-22.5" (F/E3)
Seat Height With Lower Cylinder (B7)	15"-18" (B) 15.5"-18.5" (T) 15.63"-18.68" (F) 16"-19" (F/E3)	15"-18" (B) 15.5"-18.5" (T) 15.63"-18.68" (F) 16"-19" (F/E3)
Back Width	18.75"	18.75"
Back Height	19"	23"
Materials		
COM	1 yd	1 yd
COL	17 sq ft	17 sq ft
Weight and Capacity		
Weight Armless	30 lb	31 lb
Weight With Arms	36 lb	37 lb
Weight Capacity Warranty	300 lb	300 lb

Basic mechanism (B). Swivel-tilt mechanism (T). Standard synchro mechanism (F).
Seat-depth adjustment (E3).

Wit

MESH BACK TASK STOOL

Work smarter.

Gone are the days where you clock in, stay in your cubicle and clock out. Dynamic environments call for adaptable seating that rolls with the punches. Our Wit™ family does exactly that. Because this is a design inspired by truths about how people work.

Today's ever-changing marketplace calls for flexibility. Teams need to be able to set up shop anywhere—and at any time. All of our Wit task models are easily adjustable so anyone can find a seat, settle in and get right to work.



EFFECTIVE OCTOBER 17, 2022

Featured Models

GOOD :: \$675

Midback mesh with adjustable lumbar, basic mechanism, armless, black frame, standard stool kit, carpet casters, grade 1 textile

BETTER :: \$723

Midback mesh with adjustable lumbar, basic mechanism, height-adjustable arms, black frame, standard stool kit, carpet casters, grade 1 textile

BEST :: \$822

Midback mesh with adjustable lumbar, basic mechanism, multi-adjustable arms, white frame, extended stool kit, carpet casters, grade 1 textile

Features

- Midback task stool
- Standard adjustable lumbar support
- Built-in pull handle
- 12 solid mesh back colors
- Four woven striped mesh options
- Three frame colors
- Basic mechanism
- Multi-adjustable (height/width), height-adjustable, armless and fixed arms
- Textured designer arms
- Optional brushed aluminum base
- Waterfall seat
- Standard 300 lb weight capacity warranty
- Complemented by Wit Side; see [page 286](#)

1. Back

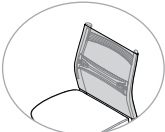
Back Size and Style	Code	Price	
Midback Mesh With Adjustable Lumbar Support	2222 B1	\$723	

2. Mechanism

Mechanism	Code	Price	
Basic (Swivel Only)	B	+ \$0	



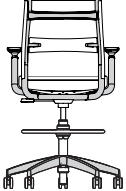

MESH BACK TASK STOOL

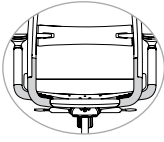
3. Frame

Frame Color	Code	Price	
Black	FC1	+ \$0	
White	FC12	+ \$45	
Fog	FC13	+ \$45	

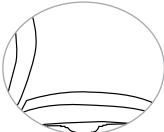
Back Support Color	Code	Price	
Black (For Black Frame FC1)	Z1	+ \$0	
Silver (For Black Frame FC1)	Z2	+ \$0	
White (For White Frame FC12)	Z4	+ \$0	
Fog (For Fog Frame FC13)	Z7	+ \$0	

4. Arms

Arm Style	Code	Price	
Armless	A0	- \$48	
Fixed	A127	- \$10	
Height-Adjustable	A128	+ \$0	
Multi-Adjustable (Height/Width)	A129	+ \$30	

Arms, if specified, come with fog arm pads for the white and fog frames and black arm pads for the black frame.

5. Base

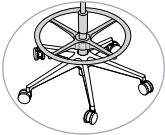
Base	Code	Price	
Stool Kit	S1	+ \$0	
Extended Stool Kit	S2	+ \$24	

Base Color and Material	Code	Price	
Black Nylon Base With Black Casters (For Black Frame FC1)	B0	+ \$0	
White Nylon Base With Fog/White Casters (For White Frame FC12)	B20	+ \$0	
Fog Nylon Base With Fog Casters (For Fog Frame FC13)	B21	+ \$0	

Brushed Aluminum Base	B8	+ \$113	
-----------------------	----	---------	---

Casters or Glides	Code	Price	
Casters			

Black Carpet Casters (For Black Frame FC1)	C16	+ \$0	
---	-----	-------	---

Black Hard Floor and Carpet Casters (For Black Frame FC1)	C17	+ \$40	
Hard Floor and Carpet Casters (For Fog or White Frame FC12/FC13)	CS6	+ \$0	

Glides			
Glides for Task Chairs	C3	+ \$30	

Brushed aluminum base (B8) can be used with any frame color.

6. Material

Protection	Code	Price	
Fire Retardancy			
CAL 133, Fabric, Quantities 1-49	133F	+ \$99	
CAL 133, Fabric, Quantities 50+	133F5	+ \$55	
CAL 133, Leather, Any Quantity	133L	+ \$119	

MESH BACK TASK STOOL

6. Material (Cont.)

Mesh Color	Code	Price	
Solid Mesh			
Apple	MC31	+ \$0	
Aqua	MC30	+ \$0	
Desert	MC22	+ \$0	
Electric Blue	MC24	+ \$0	
Fire	MC25	+ \$0	
Fog	MC23	+ \$0	
Grape	MC26	+ \$0	
Lemon	MC27	+ \$0	
Nickel	MC21	+ \$0	
Ocean	MC29	+ \$0	
Onyx	MC20	+ \$0	
Tangerine	MC28	+ \$0	

Woven Striped Mesh			
Fog	MC37	+ \$0	
Frost	MC36	+ \$0	
Nickel	MC38	+ \$0	
Onyx	MC35	+ \$0	

Seat Textile	Code	Price	
Fabric/Vinyl Grade 1	FG1/VG1	+ \$0	
COM	COM	+ \$26	
Fabric/Vinyl Grade 2	FG2/VG2	+ \$26	
Fabric/Vinyl Grade 3	FG3/VG3	+ \$60	
Fabric/Vinyl Grade 4	FG4/VG4	+ \$116	
Fabric/Vinyl Grade 5	FG5/VG5	+ \$172	
Fabric/Vinyl Grade 6	FG6/VG6	+ \$213	
Fabric/Vinyl Grade 7	FG7/VG7	+ \$254	
Leather Grade 1	LG1	+ \$300	
COL	COL	+ \$380	
Leather Grade 2	LG2	+ \$380	
Leather Grade 3	LG3	+ \$480	

Please reference the [Textile Reference Guide](#) for pricing on fabric over grade 7 and leather over grade 3. Additional CAL 133 information can be found on [page 15](#).

7. Packaging

Packaging	Code	Price	
Knocked Down	KD	+ \$0	
Back Attached to Seat, Base Separate	UC	+ \$80	
Fully Assembled in a Carton	AC	+ \$200	

EFFECTIVE OCTOBER 17, 2022 | GSA SIN #: 33721

SPECIFICATIONS

	2222 B1 S1 Midback Mesh Task Stool	2222 B1 S2 Midback Mesh Extended Task Stool
Dimensions		
Overall Width	27"	27"
Overall Depth	27"	27"
Overall Height	45.63"	50"
Seat Width	20"	20"
Seat Depth	17.5"	17.5"
Seat Height	22"- 30"	26"-36"
Back Width	19"	19"
Back Height	18.75"	18.75"
Materials		
COM	1 yd	1 yd
COL	17 sq ft	17 sq ft
Weight and Capacity		
Weight Armless	28.5 lb	29.5 lb
Weight With Arms	34.5 lb	35.5 lb
Weight Capacity Warranty	300 lb	300 lb



Wit

THINTEX BACK TASK CHAIR

Work smarter.

Gone are the days where you clock in, stay in your cubicle and clock out. Dynamic environments call for adaptable seating that rolls with the punches. Our Wit™ family does exactly that. Because this is a design inspired by truths about how people work.

Today's ever-changing marketplace calls for flexibility. Teams need to be able to set up shop anywhere—and at any time. All of our Wit task models are easily adjustable so anyone can find a seat, settle in and get right to work.



Best

Featured Models

GOOD :: \$694

Midback, swivel-tilt mechanism, height-adjustable arms, black frame, black nylon base, carpet casters, grade 1 textile

BETTER :: \$740

Highback, standard synchro mechanism, height-adjustable arms, black frame, black nylon base, carpet casters, grade 1 textile

BEST :: \$894

Highback, standard synchro mechanism with seat-depth adjustment, multi-adjustable (height/width) arms, white frame, white nylon base, carpet casters, grade 1 textile

Features

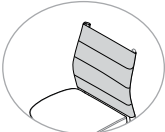
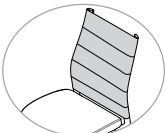

- Midback and highback task chairs
- Standard adjustable lumbar support
- Built-in pull handle
- 12 Thintex back colors in fabric or vinyl
- Three frame colors
- Standard synchro, swivel-tilt and basic mechanisms
- Multi-adjustable (height/width), height-adjustable, armless and fixed arms
- Textured designer arms
- Optional seat-depth adjustment
- Optional brushed aluminum base
- Waterfall seat
- Standard 300 lb weight capacity warranty
- Complemented by Wit Side; see [page 289](#)

1. Back

Back Size and Style	Code	Price	
Thintex Midback With Adjustable Lumbar Support	2222 B9	\$712	
Thintex Highback With Adjustable Lumbar Support	2223 B9	\$740	
Back Material	Code	Price	
Fabric	TX1	+ \$0	
Vinyl	TX2	+ \$0	

THINTEX BACK TASK CHAIR

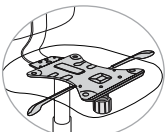
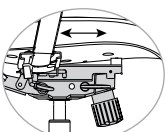

2. Mechanism

Mechanism Style	Code	Price	
Basic (Swivel Only)	B	- \$33	
Swivel-Tilt	T	- \$18	
Standard Synchro	F	+ \$0	
Standard Synchro With Seat-Depth Adjustment	F E3	+ \$79	

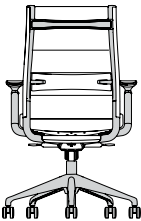
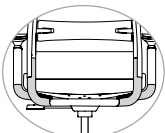
3. Frame

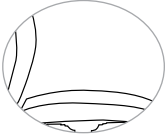

Frame Color	Code	Price	
Black	FC1	+ \$0	
White	FC12	+ \$45	
Fog	FC13	+ \$45	
Back Support Color	Code	Price	
Black (For Black Frame FC1)	Z1	+ \$0	
Silver (For Black Frame FC1)	Z2	+ \$0	
White (For White Frame FC12)	Z4	+ \$0	
Fog (For Fog Frame FC13)	Z7	+ \$0	

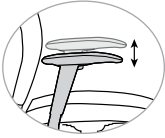
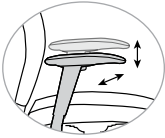
4. Arms

Arm Style	Code	Price	
Armless	A0	- \$48	
Fixed	A127	- \$10	
Height-Adjustable	A128	+ \$0	
Multi-Adjustable (Height/Width)	A129	+ \$30	

Arms, if specified, come with fog arm pads for the white and fog frames and black arm pads for the black frame.

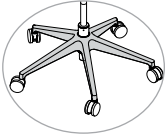
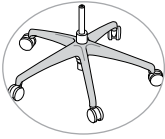
5. Base

Base Color and Material	Code	Price	
Black Nylon Base With Black Casters (For Black Frame FC1)	B0	+ \$0	
White Nylon Base With Fog/White Casters (For White Frame FC12)	B20	+ \$0	
Fog Nylon Base With Fog Casters (For Fog Frame FC13)	B21	+ \$0	
Brushed Aluminum Base	B8	+ \$113	
Heavy Duty Black Base, 26"	B7	+ \$0	

Heavy duty black base (B7) requires lower cylinder. Brushed aluminum base (B8) can be used with any frame color.

Chairs configured with the brushed aluminum base (B8) and standard synchro (F) mechanism with the High cylinder (S13)

THINTEX BACK TASK CHAIR

5. Base

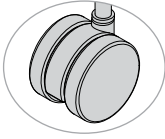
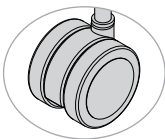
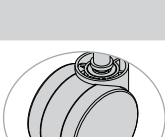
Casters or Glides	Code	Price	
Casters			
Black Carpet Casters (For Black Frame FC1)	C16	+ \$0	
Black Hard Floor and Carpet Casters (For Black Frame FC1)	C17	+ \$40	
Hard Floor and Carpet Casters (For Fog or White Frame FC12/FC13)	CS6	+ \$0	

Heavy Duty Casters

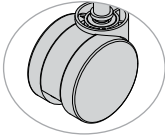
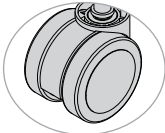
Heavy Duty Carpet Casters	C11	+ \$0	
Heavy Duty Hard Floor and Carpet Casters	C9	+ \$61	

Glides

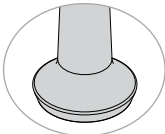
Glides for Task Chairs	C3	+ \$30	
------------------------	----	--------	---

Cylinder Height	Code	Price	
Standard Cylinder	S0	+ \$0	
Higher Cylinder	S13	+ \$0	
Lower Cylinder	S10	+ \$0	

Lower cylinder (S10) is available for Heavy Duty (HD) model only. Higher cylinder (S13) is required on chairs configured with the brushed aluminum base (B8) and standard synchro (F) mechanism.

6. Material

Protection	Code	Price	
Fire Retardancy			
CAL 133, Fabric, Quantities 1-49	133F	+ \$99	
CAL 133, Fabric, Quantities 50+	133F5	+ \$55	
CAL 133, Leather, Any Quantity	133L	+ \$119	

6. Material (Cont.)

Thintex Color	Code	Price
Apple	MC31	+ \$0
Aqua	MC30	+ \$0
Desert	MC22	+ \$0
Electric Blue	MC24	+ \$0
Fire	MC25	+ \$0
Fog	MC23	+ \$0
Grape	MC26	+ \$0
Lemon	MC27	+ \$0
Nickel	MC21	+ \$0
Ocean	MC29	+ \$0
Onyx	MC20	+ \$0
Tangerine	MC28	+ \$0
Tangerine	MC28	+ \$0

Seat Textile	Code	Price
Fabric/Vinyl Grade 1	FG1/VG1	+ \$0
COM	COM	+ \$26
Fabric/Vinyl Grade 2	FG2/VG2	+ \$26
Fabric/Vinyl Grade 3	FG3/VG3	+ \$60
Fabric/Vinyl Grade 4	FG4/VG4	+ \$116
Fabric/Vinyl Grade 5	FG5/VG5	+ \$172
Fabric/Vinyl Grade 6	FG6/VG6	+ \$213
Fabric/Vinyl Grade 7	FG7/VG7	+ \$254
Leather Grade 1	LG1	+ \$300
COL	COL	+ \$380
Leather Grade 2	LG2	+ \$380
Leather Grade 3	LG3	+ \$480

Please reference the [Textile Reference Guide](#) for pricing on fabric over grade 7 and leather over grade 3. Additional CAL 133 information can be found on page 15.

7. Packaging

Packaging	Code	Price
Knocked Down	KD	+ \$0
Back Attached to Seat, Base Separate	UC	+ \$80
Fully Assembled in a Carton	AC	+ \$200

THINTEX BACK TASK CHAIR**SPECIFICATIONS**

	2222 B9 Midback Thintex Task Chair	2223 B9 Highback Thintex Task Chair
Dimensions		
Overall Width	26"	26"
Overall Depth	26"	26"
Overall Height	36.75"	40.75"
Seat Width	20"	20"
Seat Depth	17.5"-19.5"	17.5"-19.5"
Seat Height	17.5"-21.25" (F/T) 16.63"-20.38" (B) 17.75"-21.5" (F/E3)	17.5"-21.25" (F/T) 16.63"-20.38" (B) 17.75"-21.5" (F/E3)
Seat Height With Higher Cylinder	19"-22.5" (F/T) 18"-21.5" (B) 19"-22.5" (F/E3)	19"-22.5" (F/T) 18"-21.5" (B) 19"-22.5" (F/E3)
Seat Height With Lower Cylinder (B7)	15.63"-18.68" (F) 15.5"-18.5" (T) 15"-18" (B) 16"-19" (F/E3)	15.63"-18.68" (F) 15.5"-18.5" (T) 15"-18" (B) 16"-19" (F/E3)
Back Width	18.75"	18.75"
Back Height	19"	23"
Materials		
COM	1 yd	1 yd
COL	17 sq ft	17 sq ft
Weight and Capacity		
Weight Armless	30 lb	31 lb
Weight With Arms	36 lb	37 lb
Weight Capacity Warranty	300 lb	300 lb

Basic mechanism (B). Swivel-tilt mechanism (T). Standard synchro mechanism (F). Seat-depth adjustment (E3).

Wit

THINTEX BACK TASK STOOL

Work smarter.

Gone are the days where you clock in, stay in your cubicle and clock out. Dynamic environments call for adaptable seating that rolls with the punches. Our Wit™ family does exactly that. Because this is a design inspired by truths about how people work.

Today's ever-changing marketplace calls for flexibility. Teams need to be able to set up shop anywhere—and at any time. All of our Wit task models are easily adjustable so anyone can find a seat, settle in and get right to work.



Featured Models

GOOD :: \$741

Midback task stool with adjustable lumbar, basic mechanism, armless, black frame, standard stool kit, black nylon base, carpet casters, grade 1 textile

BETTER :: \$789

Midback task stool with adjustable lumbar, basic mechanism, height-adjustable arms, black frame, standard stool kit, black nylon base, carpet casters, grade 1 textile

BEST :: \$858

Midback task stool with adjustable lumbar, basic mechanism, height-adjustable arms, fog frame, extended stool kit, fog nylon base, carpet casters, grade 1 textile

Features

- Midback task stool
- Standard adjustable lumbar support
- Built-in pull handle
- 12 Thintex back colors in fabric or vinyl
- Three frame colors
- Basic mechanism
- Multi-adjustable (height/width), height-adjustable, armless and fixed arms
- Textured designer arms
- Optional brushed aluminum base
- Waterfall seat
- Standard 300 lb weight capacity warranty
- Complemented by Wit Side; see [page 289](#)

1. Back

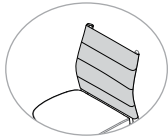
Back Size and Style	Code	Price	
Midback Thintex With Adjustable Lumbar Support	2222 B9	\$789	

Back Material	Code	Price	
Fabric	TX1	+ \$0	
Vinyl	TX2	+ \$0	

2. Mechanism

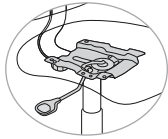
Mechanism	Code	Price	
Basic (Swivel Only)	B	+ \$0	

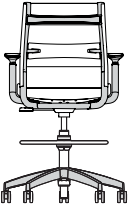

THINTEX BACK TASK STOOL

3. Frame

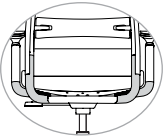
Frame Color	Code	Price	
Black	FC1	+ \$0	
White	FC12	+ \$45	
Fog	FC13	+ \$45	

Back Support Color	Code	Price	
Black (For Black Frame FC1)	Z1	+ \$0	
Silver (For Black Frame FC1)	Z2	+ \$0	
White (For White Frame FC12)	Z4	+ \$0	
Fog (For Fog Frame FC13)	Z7	+ \$0	

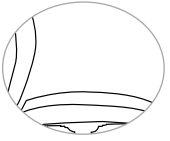
4. Arms

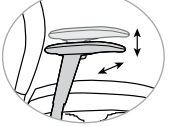
Arm Style	Code	Price	
Armless	A0	- \$48	
Fixed	A127	- \$10	
Height-Adjustable	A128	+ \$0	
Multi-Adjustable (Height/Width)	A129	+ \$30	

Arms, if specified, come with fog arm pads for the white and fog frames and black arm pads for the black frame.

5. Base

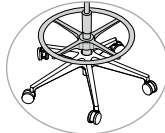
Base	Code	Price	
Stool Kit	S1	+ \$0	
Extended Stool Kit	S2	+ \$24	

Base Color and Material	Code	Price	
Black Nylon Base With Black Casters (For Black Frame FC1)	B0	+ \$0	
White Nylon Base With Fog/White Casters (For White Frame FC12)	B20	+ \$0	
Fog Nylon Base With Fog Casters (For Fog Frame FC13)	B21	+ \$0	

Brushed Aluminum Base	B8	+ \$113	
-----------------------	----	---------	---

Casters or Glides	Code	Price	
Casters			

Black Carpet Casters (For Black Frame FC1)	C16	+ \$0	
--	-----	-------	---

Black Hard Floor and Carpet Casters (For Black Frame FC1)	C17	+ \$40	
Hard Floor and Carpet Casters (For Fog or White Frame FC12/FC13)	CS6	+ \$0	

Glides			
---------------	--	--	--

Glides for Task Chairs	C3	+ \$30	
------------------------	----	--------	---

Brushed aluminum base (B8) can be used with any frame color.

THINTEX BACK TASK STOOL

6. Material

Protection	Code	Price	
Fire Retardancy			
CAL 133, Fabric, Quantities 1-49	133F	+ \$99	
CAL 133, Fabric, Quantities 50+	133F5	+ \$55	
CAL 133, Leather, Any Quantity	133L	+ \$119	

Thintex Color	Code	Price	
Apple	MC31	+ \$0	
Aqua	MC30	+ \$0	
Desert	MC22	+ \$0	
Electric Blue	MC24	+ \$0	
Fire	MC25	+ \$0	
Fog	MC23	+ \$0	
Grape	MC26	+ \$0	
Lemon	MC27	+ \$0	
Nickel	MC21	+ \$0	
Ocean	MC29	+ \$0	
Onyx	MC20	+ \$0	
Tangerine	MC28	+ \$0	

Seat Textile	Code	Price	
Fabric/Vinyl Grade 1	FG1/VG1	+ \$0	
COM	COM	+ \$26	
Fabric/Vinyl Grade 2	FG2/VG2	+ \$26	
Fabric/Vinyl Grade 3	FG3/VG3	+ \$60	
Fabric/Vinyl Grade 4	FG4/VG4	+ \$116	
Fabric/Vinyl Grade 5	FG5/VG5	+ \$172	
Fabric/Vinyl Grade 6	FG6/VG6	+ \$213	
Fabric/Vinyl Grade 7	FG7/VG7	+ \$254	
Leather Grade 1	LG1	+ \$300	
COL	COL	+ \$380	
Leather Grade 2	LG2	+ \$380	
Leather Grade 3	LG3	+ \$480	

Please reference the [Textile Reference Guide](#) for pricing on fabric over grade 7 and leather over grade 3. Additional CAL 133 information can be found on [page 15](#).

EFFECTIVE OCTOBER 17, 2022 | GSA SIN #: 33721

7. Packaging

Packaging	Code	Price
Knocked Down	KD	+ \$0
Back Attached to Seat, Base Separate	UC	+ \$80
Fully Assembled in a Carton	AC	+ \$200

SPECIFICATIONS

	2222 B9 S1 Midback Thintex Task Stool	2222 B9 S2 Midback Thintex Extended Task Stool
Dimensions		
Overall Width	27"	27"
Overall Depth	27"	27"
Overall Height	8.5" (B0/B20/B21) 36.5" (B8)	43" (B0/B20/B21) 41" (B8)
Seat Width	20"	20"
Seat Depth	17.5"	17.5"
Seat Height	22"-30"	26"-36"
Back Width	19"	19"
Back Height	18.75"	18.75"
Weight Armless	28.5 lb	29.5 lb
Weight With Arms	34.5 lb	35.5 lb
Materials		
COM	1 yd	1 yd
COL	17 sq ft	17 sq ft
Weight and Capacity		
Weight Capacity Warranty	300 lb	300 lb

Black base (B0). White base (B20). Fog base (B21). Brushed aluminum base (B8).



Chairs and Stools

MULTIPURPOSE | SIDE | GUEST | BARIATRIC
COUNTER STOOL | BAR STOOL

Statement of Line

MULTIPURPOSE | SIDE | GUEST | BARIATRIC
COUNTER STOOL | BAR STOOL

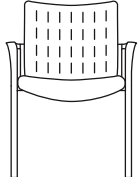

Achieve
4-Leg Multipurpose Chair
91 US..... [Page 204](#)

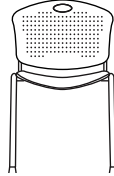

Anytime
4-Leg Multipurpose Chair
93..... [Page 207](#)

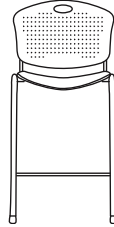

Anytime
4-Leg Bar Stool
93 S2 [Page 207](#)



Baja
Wire Rod Multipurpose Chair
1171 FT2 BK4..... [Page 211](#)

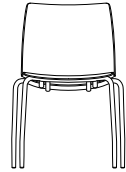

Baja
4-Leg Multipurpose Chair
1171 FT1 BK4..... [Page 211](#)

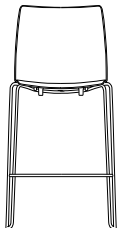

Baja
Wire Bar Stool
1171 FT2 S2 BK4.... [Page 211](#)

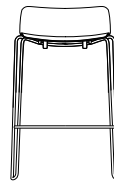

Baja
Low Back Wire Rod Bar
1171 FT2 S2 BK3.... [Page 211](#)

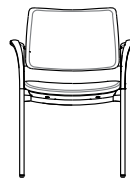

Cora
Guest Chair
5651/5652 [Page 216](#)

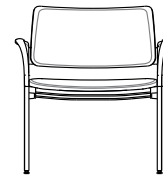

Cora
Midsize Chair
5651/5652 [Page 216](#)

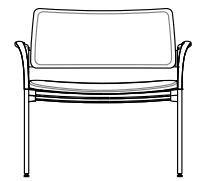

Cora
Bariatric Chair
5651/5652 [Page 216](#)

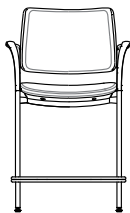

Cora
Counter Stool
1191 SW19 S9..... [Page 216](#)

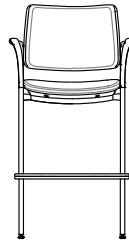

Cora
Bar Stool
1191 SW19 S2..... [Page 216](#)

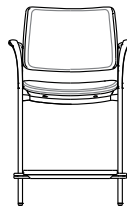

Cora
Easy Access Hip Chair
1191 SW19 S4..... [Page 216](#)

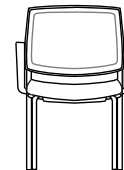

Focus Side Mesh
4-Leg Side Chair
5651/5652 [Page 222](#)

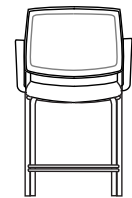

Focus Side Mesh
4-Leg Counter Stool
5651/5652 S9 [Page 222](#)

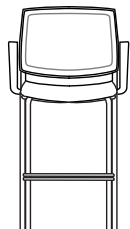

Focus Side Mesh
4-Leg Bar Stool
5651/5652 S2..... [Page 222](#)

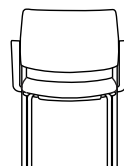

Focus Side Upholstered
4-Leg Side Chair
5651/5652 [Page 222](#)

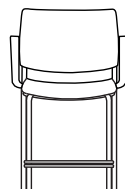

Focus Side Upholstered
4-Leg Counter Stool
5651/5652 S9 [Page 222](#)

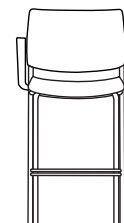

Focus Side Upholstered
4-Leg Bar Stool
5651/5652 S2 [Page 222](#)

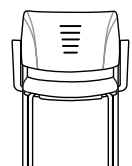

Focus Side Wood
4-Leg Side Chair
5651/5652 [Page 222](#)

Statement of Line

MULTIPURPOSE | SIDE | GUEST | BARIATRIC
COUNTER STOOL | BAR STOOL

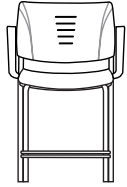

Focus Side Wood

4-Leg Counter Stool
5651/5652 S9 [Page 222](#)

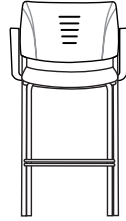

Focus Side Wood

4-Leg Bar Stool
5651/5652 S2 [Page 222](#)

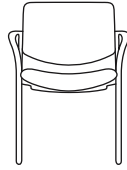

Freelance

4-Leg Multipurpose Chair
521X [Page 227](#)

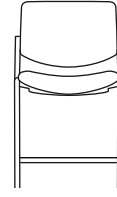

Freelance

4-Leg Counter Stool
5214 S9 [Page 227](#)

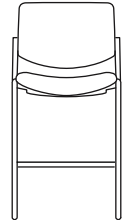

Freelance

4-Leg Bar Stool
5214 S2 [Page 227](#)



Freelance

30" Bariatric Chair
5314 [Page 233](#)

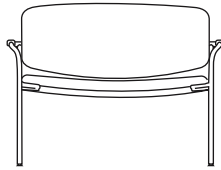

Freelance

42" Bariatric Chair
5414 [Page 233](#)

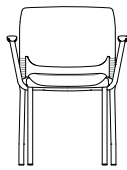

InFlex

4-Leg Multipurpose Chair
971 [Page 236](#)

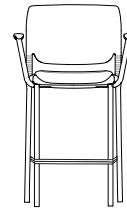

InFlex

4-Leg Counter Stool
971 S9 [Page 236](#)

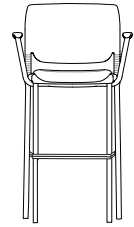

InFlex

4-Leg Bar Stool
971 S2 [Page 236](#)

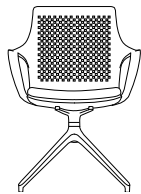

Ioniq

4-Star Guest Chair
1152 FT5 [Page 240](#)

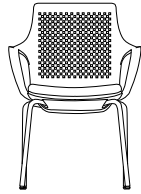

Ioniq

4-Leg Multipurpose Chair
1151 FT1 [Page 242](#)

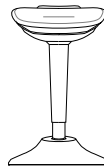

Kickstand

Stool
1167 [Page 244](#)

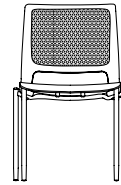

Lumin

4-Leg Multipurpose Chair
1011 FT1 [Page 246](#)

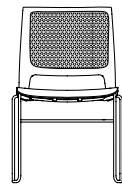

Lumin

Wire Rod Multipurpose Chair
1011 FT2 [Page 246](#)

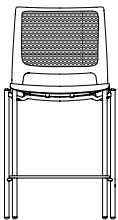

Lumin

4-Leg Counter Stool
1011 FT1 S9 [Page 246](#)

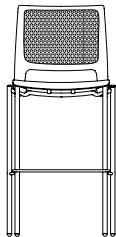

Lumin

4-Leg Bar Stool
1011 FT1 S2 [Page 246](#)

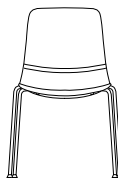

Mika

4-Leg Multipurpose Chair
1101 FT1 S9 [Page 251](#)

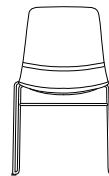

Mika

Wire Rod Multipurpose Chair
1101 FT1 S9 [Page 251](#)

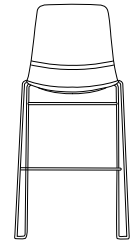

Mika

Wire Rod Bar Stool
1101 FT1 S9 [Page 251](#)

Statement of Line

MULTIPURPOSE | SIDE | GUEST | BARIATRIC
COUNTER STOOL | BAR STOOL

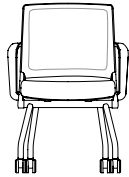

Movi
Nester Chair
1061 FT4..... [Page 255](#)

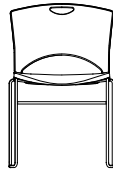

OnCall
Wire Rod Multipurpose Chair
90..... [Page 258](#)

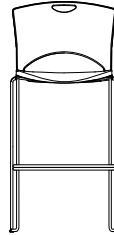

OnCall
Wire Rod Bar Stool
90 S2..... [Page 258](#)

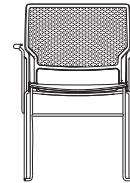

Orbix
Wire Rod Chair
1131 FT2..... [Page 262](#)



Orbix
Wire Rod Bar Stool
1131 FT2 S2..... [Page 262](#)

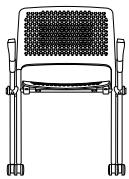

Qwiz
Nester Chair
1141 FT4..... [Page 266](#)

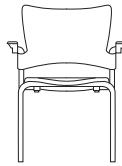

Relay
Multipurpose Chair
94S..... [Page 270](#)

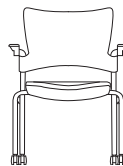

Relay
Nester Chair
94XB/94XS..... [Page 273](#)

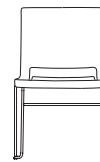

Rio
Wire Rod Multipurpose Chair
1051 FT2..... [Page 276](#)

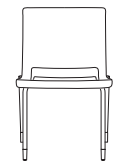

Rio
4-Leg Multipurpose Chair
1051 FT1..... [Page 276](#)

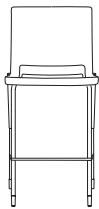

Rio
4-Leg Counter Stool
1051 FT1 S9..... [Page 276](#)



Rio
4-Leg Bar Stool
1051 FT1 S2..... [Page 276](#)

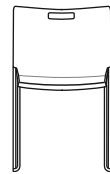

Rowdy
Wire Rod Chair
92 SB/92 SC..... [Page 280](#)



Sprout
Wire Rod Chair
1181 FT2..... [Page 283](#)

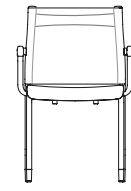

Wit Side Mesh
4-Leg Side Chair
2221 FT1 MB..... [Page 286](#)

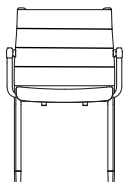

Wit Side Thintex
4-Leg Side Chair
2221 FT1 TXB..... [Page 289](#)

Achieve

MULTIPURPOSE CHAIR

Own the space.

Achieve upholstered and plastic side chairs provide the feel of a large chair but with a clean and slender profile. The concave back and contoured seat match the natural curves of the human body, combining comfortable ergonomic support with eye-catching contemporary design. The plastic model's perforated back allows the body to breathe, keeping the user cool while seated.



EFFECTIVE OCTOBER 17, 2022

Featured Models

GOOD :: \$555

4-leg chair, plastic back and upholstered seat, armless, standard multi-surface glides, grade 1 textile

BETTER :: \$671

4-leg chair, upholstered seat and back, fixed loop arms, standard multi-surface glides, grade 1 textile

BEST :: \$711

4-leg chair, upholstered seat and back, fixed loop arms, carpet casters, grade 1 textile

Features

- Clean and contemporary, ideal for guest and lobby areas, meeting and conference rooms
- Fully upholstered or plastic back with upholstered seat
- Generously proportioned contoured design follows the curves of the body
- Waterfall seat promotes proper leg circulation
- Wall-saver anti-tip frame design
- Additional seat foam option
- 250 lb weight capacity warranty

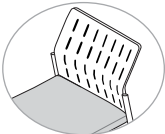
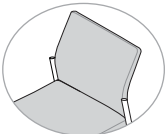

1. Back

Back and Seat Style	Code	Price	
Black Plastic Back, Upholstered Seat	91 US	\$613	
Upholstered Seat and Back	91 UP	\$671	

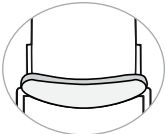
2. Seat

Seat Options	Code	Price	
1" Additional Foam	F1	+\$36	

3. Frame

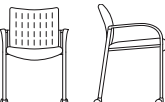
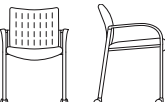
Frame Finish and Style	Code	Price	
Black	FB	+\$0	
Silver	FS	+\$0	
Black With Black Carpet Casters	FCB	+\$40	
Silver With Black Carpet Casters	FCS	+\$40	

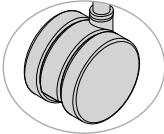
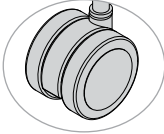
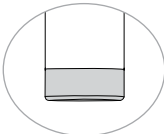

MULTIPURPOSE CHAIR

4. Base

Casters or Glides	Code	Price	
Casters			
Carpet Casters	C13	+\$0	
Hard Floor and Carpet Casters	C12	+\$40	
Glides			
Standard Multi-Surface Glides	G6	+\$0	

Please use caution when stacking models with casters to prevent frame damage. SitOnIt Seating does not warrant scratched frames.

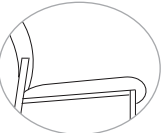
5. Arms

Arm Style	Code	Price	
Armless	A0	-\$58	
Fixed Loop	A40	+\$0	

6. Miscellaneous

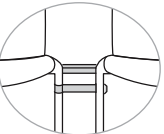
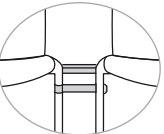
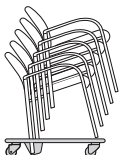
Accessories	Code	Price	
Ganging Bracket for Armless Models	GG4	+\$28	
Ganging Bracket for Models With Arms	GA4	+\$28	
Stacking Cart	14-Cart	+\$324	

Ganging brackets and stacking carts are not intended for use with caster models and are compatible with glides only. See page 594 for additional stacking requirements.

7. Material

Protection	Code	Price
Fire Retardancy		
CAL 133, Fabric, Quantities 1-49	133F	+ \$99
CAL 133, Fabric, Quantities 50+	133F5	+ \$55
CAL 133, Leather, Any Quantity	133L	+ \$119

Textile	Code	Price
Seat Textile (For US)		
Fabric/Vinyl Grade 1	FG1/VG1	+ \$0
COM	COM	+ \$22
Fabric/Vinyl Grade 2	FG2/VG2	+ \$22
Fabric/Vinyl Grade 3	FG3/VG3	+ \$45
Fabric/Vinyl Grade 4	FG4/VG4	+ \$77
Fabric/Vinyl Grade 5	FG5/VG5	+ \$116
Fabric/Vinyl Grade 6	FG6/VG6	+ \$159
Fabric/Vinyl Grade 7	FG7/VG7	+ \$200
Leather Grade 1	LG1	+ \$140
COL	COL	+ \$200
Leather Grade 2	LG2	+ \$200
Leather Grade 3	LG3	+ \$280

Seat and Back (For UP)		
Fabric/Vinyl Grade 1	FG1/VG1	+ \$0
COM	COM	+ \$34
Fabric/Vinyl Grade 2	FG2/VG2	+ \$34
Fabric/Vinyl Grade 3	FG3/VG3	+ \$74
Fabric/Vinyl Grade 4	FG4/VG4	+ \$121
Fabric/Vinyl Grade 5	FG5/VG5	+ \$174
Fabric/Vinyl Grade 6	FG6/VG6	+ \$235
Fabric/Vinyl Grade 7	FG7/VG7	+ \$296
Leather Grade 1	LG1	+ \$260
COL	COL	+ \$320
Leather Grade 2	LG2	+ \$320
Leather Grade 3	LG3	+ \$400

Please reference the [Textile Reference Guide](#) for pricing on fabric over grade 7 and leather over grade 3.

Please reference the Fabric information found on [page 17](#) for pricing on multi-upholstery.

MULTIPURPOSE CHAIR

8. Packaging

Packaging	Code	Price
Fully Assembled In a Carton	AC3	+ \$0
Fully Assembled In a Carton, Individually Packaged	AC1	+ \$20

SPECIFICATIONS

Model:	91 Multipurpose Chair
Dimensions	
Overall Width Armless	22"
Overall Width With Arms	25"
Overall Depth	24"
Overall Height	33.5"
Seat Width	19.5"
Seat Depth	19"
Seat Height	18"
Back Width	18"
Back Height	16"
Materials	
COM	1 yd (US), 1.75 yd (UP)
COL	17 sq ft (US), 30 sq ft (UP)
Stacking	
Max Cart Stacking	5
Max Floor Stacking	4
Weight and Capacity	
Weight Armless	18 lb
Weight With Arms	21 lb
Weight Capacity Warranty	250 lb

Upholstered seat only (US). Upholstered seat and back (UP).

Anytime

MULTIPURPOSE CHAIR AND BAR STOOL

Grab and go. Anywhere.

The economical Anytime collection was designed for corporate, government and educational settings where flexibility and style are key requirements. The perforated plastic back provides ample ventilation and upholstered pads can be added for increased comfort. You can specify Anytime as fully upholstered or with an upholstered seat only. Frame colors are either black or silver. The pull handle ensures that the Anytime side chair is ready to go anytime and anywhere it is needed.



EFFECTIVE OCTOBER 17, 2022

Featured Models

GOOD :: \$333

4-leg chair, all plastic, armless, standard multi-surface glides

BETTER :: \$391

4-leg chair, upholstered seat, plastic back, armless, standard multi-surface glides



BEST :: \$507

4-leg chair, upholstered seat and back, fixed arms, standard multi-surface glides

Features

- Fully upholstered, upholstered seat or plastic
- Three plastic colors
- Perforated shell provides ventilation
- Built-in pull handle
- Black or silver tubular frame
- Stacks six on the floor; eight on the optional cart
- 250 lb weight capacity warranty
- Complements Anytime light task chair and stool; see [page 53](#)

1. Back

Back and Seat Style	Code	Price	
Plastic	No Code	\$333	
Upholstered Seat Only	US	\$391	
Upholstered Seat and Back	UP	\$449	

2. Frame

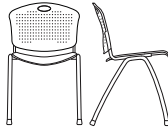
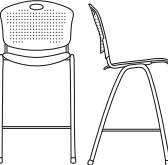
Frame Type	Code	Price	
4-Leg	93	+ \$0	
30" Bar Stool	93 S2	+ \$150	



Bar stools (S2) are available with glides only.

MULTIPURPOSE CHAIR AND BAR STOOL

2. Frame (Cont.)

Frame Finish	Code	Price	
Black	FB	+ \$0	
Black With Casters	FCB	+ \$40	
Silver	FS	+ \$0	
Silver With Casters	FCS	+ \$40	

3. Arms

Arm Style	Code	Price	
Armless	A0	+ \$0	
Fixed Loop Arms (Black)	A48	+ \$58	
Fixed Loop Arms (Silver)	A49	+ \$58	

4. Base

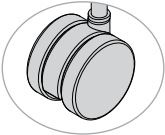
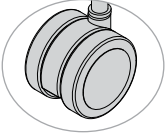
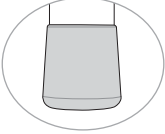
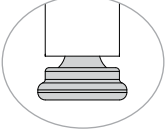
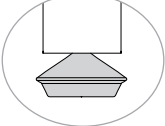
Casters or Glides	Code	Price	
Casters			
Carpet Casters	C13	+ \$0	
Hard Floor and Carpet Casters	C12	+ \$40	
Glides			
Standard Multi-Surface Glides	G7	+ \$0	
Floor Saver Glides	G15	+ \$17	
Steel Glides (Carpet Only)	G14	+ \$17	
Performance Multi-Surface Glides	GL2	+ \$17	

Casters not available with bar stool (S2). Do not stack chairs with casters.

5. Miscellaneous

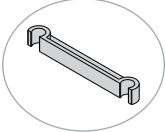
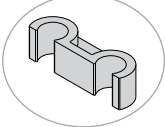
Ganging	Code	Price	
Ganging Bracket for Armless Models	GG6	+ \$30	
Ganging Bracket for Models With Arms	GA6	+ \$30	

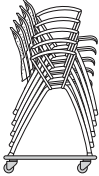
Stacking	Code	Price	
Stacking Cart	93-Cart	+ \$324	

Ganging brackets and stacking carts are not available for caster models and are only available for chairs with glides.

Due to the nature of upholstery, stacking may cause impressions on the seat. SitOnIt Seating does not warrant the effects of stacking on upholstery.

See [page 594](#) for additional stacking requirements.



Best

MULTIPURPOSE CHAIR AND BAR STOOL

6. Material

Protection	Code	Price	
Fire Retardancy			
CAL 133, Fabric, Quantities 1-49	133F	+ \$99	
CAL 133, Fabric, Quantities 50+	133F5	+ \$55	
CAL 133, Plastic, Any Quantity	133P	+ \$45	
Shell Color			
Black	SC1	+ \$0	
Navy	SC5	+ \$0	
Slate	SC8	+ \$0	
Textile			
Seat Only (For US)			
Fabric/Vinyl Grade 1	FG1/VG1	+ \$0	
COM	COM	+ \$22	
Fabric/Vinyl Grade 2	FG2/VG2	+ \$22	
Fabric/Vinyl Grade 3	FG3/VG3	+ \$45	
Fabric/Vinyl Grade 4	FG4/VG4	+ \$77	
Fabric/Vinyl Grade 5	FG5/VG5	+ \$116	
Fabric/Vinyl Grade 6	FG6/VG6	+ \$159	
Fabric/Vinyl Grade 7	FG7/VG7	+ \$200	
Seat and Back (For UP)			
Fabric/Vinyl Grade 1	FG1/VG1	+ \$0	
COM	COM	+ \$34	
Fabric/Vinyl Grade 2	FG2/VG2	+ \$34	
Fabric/Vinyl Grade 3	FG3/VG3	+ \$74	
Fabric/Vinyl Grade 4	FG4/VG4	+ \$121	
Fabric/Vinyl Grade 5	FG5/VG5	+ \$174	
Fabric/Vinyl Grade 6	FG6/VG6	+ \$235	
Fabric/Vinyl Grade 7	FG7/VG7	+ \$296	

Please reference the [Textile Reference Guide](#) for pricing on fabric over grade 7. See [page 15](#) for more information on CAL 133.

Please reference the Fabric information found on [page 17](#) for pricing on multi-upholstery.

7. Packaging

Packaging	Code	Price	
Fully Assembled In a Carton	AC	+ \$0	
Fully Assembled In a Carton, Individually Packaged	AC1	+ \$20	

EFFECTIVE OCTOBER 17, 2022 | GSA SIN #: 33721

SPECIFICATIONS

Model:	93 4-Leg Multipurpose	93 S2 30" Bar Stool
Dimensions		
Overall Width Armless	21.5"	22"
Overall Width With Arms	26.5"	27"
Overall Depth	22"	22"
Overall Height	32.5"	44"
Seat Width	19"	19"
Seat Depth	18"	18"
Seat Height	18"	30.5"
Back Width	21.5"	21.5"
Back Height	14.5"	14.5"
Materials		
COM	0.8 yd (US) 1 yd (UP)	0.8 yd (US) 1 yd (UP)
Stacking		
Max Cart Stacking	8	N/A
Max Floor Stacking	6	N/A
Weight and Capacity		
Weight Armless	14 lb	21.5 lb
Weight With Arms	18 lb	25.5 lb
Weight Capacity Warranty	250 lb	250 lb

Upholstered seat (US). Upholstered seat and back (UP).



Baja

MULTIPURPOSE CHAIR AND BAR STOOL

Immerse in possibilities.

Let's come together. When you want to feel the room and fill the room, there's Baja. Its comfort, customization, features and function will stand out— all while blending in – and echo the vibe of any space with subtle sophistication. Discover what's possible when you're surrounded by cohesive design.



Good

EFFECTIVE OCTOBER 17, 2022

Featured Models

GOOD :: \$395

All plastic, 4-leg, armless, standard multi-surface glides

BETTER :: \$453

Plastic back and upholstered seat, 4-leg, armless, standard multi-surface glides, grade 1 textile



BEST :: \$569

Fully upholstered, 4-leg, fixed arms, standard multi-surface glides, grade 1 textile

Features

- Scale and sculpture offer a roomier, more comfortable sit
- Seamless design and broad collection create cohesion in any space
- Residential-inspired features and options, including standard and low-back stools
- Responsive, single-piece shell offers 18 degrees of backrest flex
- Bases include wire rod, wire rod stool and 4-leg with casters or glides
- Choose from 14 shell colors, three arm pad colors, two wire rod and three 4-leg finishes
- Stackable on the floor or on a cart for quick clean-up and easy storage
- 300 lb weight capacity warranty





1. Frame

Frame Type	Code	Price	
4-Leg	1171 FT1	\$395	
Wire Rod	1171 FT2	\$372	
30" Wire Rod Bar Stool	1171 FT2 S2	\$522	

Frame Finish	Code	Price	
4-Leg (FT1) Only			
Black	FC1	+ \$0	
Silver	FC2	+ \$0	
White	FC12	+ \$0	
Wire Rod (FT2) Only			
Black	FC1	+ \$0	
Chrome	FC15	+ \$0	

MULTIPURPOSE CHAIR AND BAR STOOL

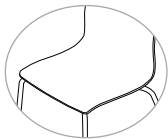
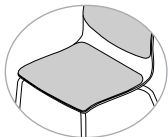
2. Back and Seat

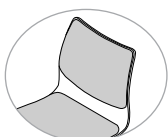

Back Size	Code	Price	
Standard Back	BK4	+ \$0	
Low Back	BK3	+ \$0	
Seat Style	Code	Price	
Plastic Seat	PS	+ \$0	
Upholstered Seat	US	+ \$58	
Back Style	Code	Price	
Plastic Back	PB	+ \$0	
Upholstered Back	UB	+ \$58	

Low back option available for bar stool (S2) only.

Upholstered back (UB) option available only with upholstered seat (US) and is not compatible with the low back (BK3) option.

Due to the nature of upholstery, stacking may cause impressions on the seat. SitOnIt Seating does not warrant the effects of stacking on upholstery.

3. Arms

Arm Style	Code	Price	
Armless	AR0	+ \$0	
Fixed Arms	AR1	+ \$58	

Fixed arms available on 4-leg chair (FT1) only. Arm finish matches frame finish. Arm pads are black (FC1) frame or fog on the silver (FC2) and white on the white (FC12) frames.

4. Base

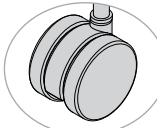
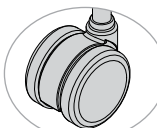
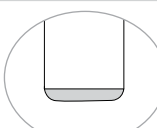
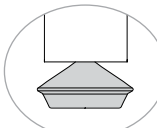
Casters or Glides	Code	Price	
Casters (For 4-Leg Chair FT1 Only)			
Carpet Casters	CS5	+ \$40	
Hard Floor and Carpet Casters	CS6	+ \$80	
Glides (For 4-Leg Chair FT1 Only)			
Standard Multi-Surface Glides	GL1	+ \$0	
Performance Multi-Surface Glides	GL2	+ \$17	

MULTIPURPOSE CHAIR AND BAR STOOL

4. Base (Cont.)

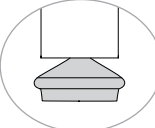
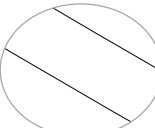
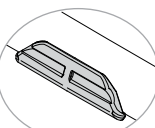
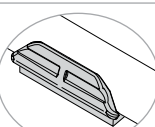

Casters or Glides	Code	Price	
Floor Saver Glides	GL3	+ \$17	
Steel Glides (Carpet Only)	GL4	+ \$17	
Glides (For Wire Rod FT2 Only)			
No Glides	G0	+ \$0	
Clear Glides	CGR	+ \$9	
Clear Glides With Felt	CGRF	+ \$22	

Casters are black on the black (FC1) frame or fog on the silver (FC2) and white on the white (FC12) frames.



Best

5. Miscellaneous

Accessories	Code	Price	
Ganging Bracket	GG	+ \$30	
Stacking Cart	CART	+ \$399	

Ganging Brackets (GG) available on armless (AR0) models only.

Please use caution when stacking models with casters to prevent frame damage. SitOnIt Seating does not warrant scratched frames.

See [page 594](#) for additional stacking requirements.



Better

MULTIPURPOSE CHAIR AND BAR STOOL

6. Material

Shell Color	Code	Price	
Black	SC1	+ \$0	
Chocolate	SC4	+ \$0	
Latte	SC20	+ \$0	
Navy	SC5	+ \$0	
Slate	SC8	+ \$0	
Apple	SC24	+ \$0	
Arctic	SC21	+ \$0	
Bisque	SC7	+ \$0	
Lagoon	SC15	+ \$0	
Lemon	SC25	+ \$0	
Pacific	SC22	+ \$0	
Red	SC19	+ \$0	
Sterling	SC18	+ \$0	
Tangerine	SC23	+ \$0	

Textile	Code	Price	
Seat Only (US)			
Fabric/Vinyl Grade 1	FG1/VG1	+ \$0	
COM	COM	+ \$22	
Fabric/Vinyl Grade 2	FG2/VG2	+ \$22	
Fabric/Vinyl Grade 3	FG3/VG3	+ \$45	
Fabric/Vinyl Grade 4	FG4/VG4	+ \$77	
Fabric/Vinyl Grade 5	FG5/VG5	+ \$116	
Fabric/Vinyl Grade 6	FG6/VG6	+ \$159	
Fabric/Vinyl Grade 7	FG7/VG7	+ \$200	
Seat and Back (US + UB)			
Fabric/Vinyl Grade 1	FG1/VG1	+ \$0	
COM	COM	+ \$34	
Fabric/Vinyl Grade 2	FG2/VG2	+ \$34	
Fabric/Vinyl Grade 3	FG3/VG3	+ \$74	
Fabric/Vinyl Grade 4	FG4/VG4	+ \$121	
Fabric/Vinyl Grade 5	FG5/VG5	+ \$174	
Fabric/Vinyl Grade 6	FG6/VG6	+ \$235	
Fabric/Vinyl Grade 7	FG7/VG7	+ \$296	

Please reference the [Textile Reference Guide](#) for pricing on fabric over grade 7.

7. Packaging

Packaging	Code	Price	
Fully Assembled In a Carton	AC	+ \$0	
Fully Assembled In a Carton, Individually Packaged	AC1	+ \$20	

CHAIR SPECIFICATIONS

Model:	1171 FT1 4-Leg Chair	1171 FT2 Wire Rod Chair
Dimensions		
Overall Width With Arms	27"	N/A
Overall Width Armless	22.25"	22"
Overall Depth	21.5"	22.5"
Overall Height	32.5"	32"
Seat Width	18.5"	18.5"
Seat Depth	18"	18"
Seat Height	18"	17.5"
Back Width	18.25"	18.25"
Back Height	15.75"	16.5"
Materials		
COM	0.75 yd (US) 1 yd (UB)	0.75 yd (US) 1 yd (UB)
Stacking		
Max Cart Stacking Armless	10 (PS) 8 (US/UB)	6 (PS) 4 (US/UB)
Max Cart Stacking With Arms	10 (PS) 8 (US/UB)	N/A
Max Floor Stacking Armless	6 (PS) 4 (US/UB)	6
Max Floor Stacking With Arms	6 (PS) 4 (US/UB)	N/A
Weight and Capacity		
Weight With Arms	18 lb	N/A
Weight Armless	16 lb	15 lb
Weight Capacity Warranty	300 lb	300 lb

Plastic seat (PS). Upholstered seat (US). Upholstered back (UB).

MULTIPURPOSE CHAIR AND BAR STOOL

STOOL SPECIFICATIONS

Model:	1171 FT2 S2 30" Wire Rod Bar Stool
Dimensions	
Overall Width Armless	22"
Overall Depth	22.5"
Overall Height	45" (BK4) 35.25" (BK3)
Seat Width	18.5"
Seat Depth	18"
Seat Height	29.5"
Back Width	18.25"
Back Height	16.5" (BK4) 7" (BK3)
Materials	
COM	0.75 yd (US) 1 yd (UB)
Stacking	
Floor Stacking	4
Weight and Capacity	
Weight Armless	22 lb (BK4) 20 lb (BK3)
Weight Capacity	300 lb

Upholstered seat (US). Upholstered back (UB). Standard back (BK4). Low back (BK3).

Cora

MULTIPURPOSE CHAIR, BARIATRIC,
COUNTER STOOL AND BAR STOOL

Ability for any facility.

With expert insights from Certified Healthcare Interior Designers® (CHID), Cora was designed to withstand the high demands of our modern spaces. It's a research-driven solution engineered for cleanability, reliability and durability—while ensuring central comfort and cohesion across every model.



EFFECTIVE OCTOBER 17, 2022

Featured Models

GUEST :: \$472

Guest chair, upholstered back, upholstered seat, fixed arms, standard multi-surface glides, grade 1 textile

MIDSIZE :: \$622

Midsized chair, upholstered back, upholstered seat, fixed arms, performance multi-surface glides, grade 1 textile

BARIATRIC :: \$875

Bariatric chair, upholstered back, upholstered seat, fixed arms, performance multi-surface glides, grade 1 textile

Features

- Designed with expert insight from Certified Healthcare Interior Designers®
- A high-performing solution for any industry, including corporate, healthcare, education and more
- Easy to maintain with clean-out space and field replaceable components, including seat and back
- Wall-saver frame keeps everything fresh, preventing scuffs and marks
- Looped arms are streamlined yet wide enough to sit down and get up with ease
- Bleach cleanable, multi-upholstery and ballistic nylon options
- Edge-to-edge underseat cover provides full coverage on the guest model for enhanced stacking (four on floor; six on cart)
- Meets Healthier Hospitals Safer Chemicals Challenge 2.3, BIFMA LEVEL, GreenGuard Gold, and BIFMA X5.1 to X5.41
- Curated collection with an array of weight capacity warranties—guest model, easy access hip chair, counter stool and bar stool (500 lb), midsize model (600 lb), and bariatric model (750 lb)

MULTIPURPOSE CHAIR, BARIATRIC, COUNTER STOOL AND BAR STOOL

1. Frame



Frame Type	Code	Price	
Guest (500 lb Capacity)	1191 SW19	\$472	
Midsize (600 lb Capacity)	1191 SW26	\$622	
Bariatric (700 lb Capacity)	1191 SW30	\$875	
Counter Stool (500 lb Capacity)	1191 SW19 S9	\$622	
Bar Stool (500 lb Capacity)	1191 SW19 S2	\$622	
Easy Access Hip Chair (500 lb Capacity)	1191 SW19 S4	\$787	
Frame Finish	Code	Price	
Black	FC1	+ \$0	
Silver	FC2	+ \$0	

See the Super Duty Guide on page 591 for additional high weight capacity models.

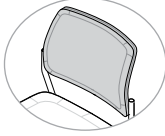
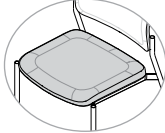
2. Back and Seat

Back Style	Code	Price	
Upholstered Back	UB	+ \$0	
Seat Style	Code	Price	
Upholstered Seat	US	+ \$0	

3. Arms

Arm Style	Code	Price	
Armless	AR0	- \$58	
Fixed	AR1	+ \$0	

Arm Cap Finish	Code	Price	
Black	AC3	+ \$0	
Fog	AC6	+ \$0	

Armless (AR0) option is available on guest (SW19) chairs, counter (SW19 S9) and bar (SW19 S2) stools only.

MULTIPURPOSE CHAIR, BARIATRIC, COUNTER STOOL AND BAR STOOL

4. Base

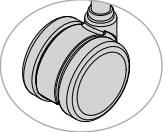
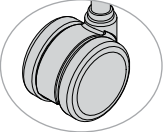
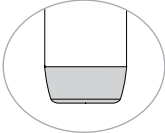
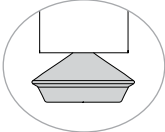
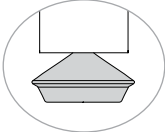
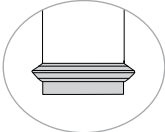
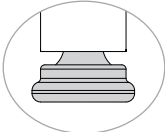

Casters or Glides	Code	Price	
Casters			
Carpet Casters	CS5	+ \$40	
Hard Floor and Carpet Casters	CS6	+ \$80	
Glides			
Standard Multi-Surface Glides	GL1	+ \$0	
Performance Multi-Surface Glides for Guest Chair	GL2	+ \$17	
Performance Multi-Surface Glides for Midsize or Bariatric Chair	GL2	+ \$0	
Floor Saver Glides	GL3	+ \$17	
Steel Glides (Carpet Only)	GL4	+ \$17	

Standard multi-surface glides (GL1) are not available on midsize (SW26) or bariatric (SW30) chairs. Performance multi-surface glides (GL2) are standard on midsize (SW26) or bariatric (SW30) chairs. Caster color coordinates with frame color. Casters are available on guest (SW19) models only.

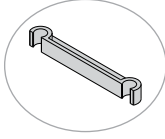
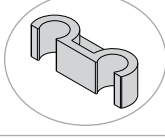

Bariatric

5. Miscellaneous

Accessories	Code	Price	
Ganging Bracket (Fixed Arms Only)	GA	+ \$30	
Ganging Bracket (Armless Only)	GG	+ \$30	
Stacking Cart	CART	+ \$399	

Stacking cart is only compatible with guest (SW19) models and is not compatible with casters (CS5/CS6). See page 594 for additional stacking requirements.

6. Material

Cleaning	Code	Price	
Moisture Barrier			Guest Midsize/ Bariatric
Seat Only	UM2	+ \$35	+ \$35
Ballistic Nylon	Code	Price	
Ballistic Nylon Back	BN	+ \$0	+ \$0
Fully Upholstered	Code	Price	
Seat and Back Upholstery			Guest/Hip Chair/Stools Midsize/ Bariatric
Fabric/Vinyl Grade 1	FG1/VG1	+ \$0	+ \$0
COM	COM	+ \$34	+ \$40
Fabric/Vinyl Grade 2	FG2/VG2	+ \$34	+ \$40
Fabric/Vinyl Grade 3	FG3/VG3	+ \$74	+ \$84
Fabric/Vinyl Grade 4	FG4/VG4	+ \$121	+ \$156
Fabric/Vinyl Grade 5	FG5/VG5	+ \$174	+ \$228
Fabric/Vinyl Grade 6	FG6/VG6	+ \$235	+ \$304
Fabric/Vinyl Grade 7	FG7/VG7	+ \$296	+ \$378
Leather Grade 1	LG1	+ \$140	+ \$240
COL	COL	+ \$200	+ \$540
Leather Grade 2	LG2	+ \$200	+ \$540
Leather Grade 3	LG3	+ \$280	+ \$820

MULTIPURPOSE CHAIR, BARIATRIC,
COUNTER STOOL AND BAR STOOL

6. Material (Cont.)

Multi-Upholstery	Code	Price	
Upcharge			Guest/Hip Chair/Stools Midsize/ Bariatric
Multi-Upholstery Upcharge	UMU	+ \$58	+ \$58
Seat Upholstery Only			Guest/Hip Chair/Stools Midsize/ Bariatric
Fabric/Vinyl Grade 1	FG1/VG1	+ \$0	+ \$0
COM	COM	+ \$22	+ \$26
Fabric/Vinyl Grade 2	FG2/VG2	+ \$22	+ \$26
Fabric/Vinyl Grade 3	FG3/VG3	+ \$45	+ \$60
Fabric/Vinyl Grade 4	FG4/VG4	+ \$77	+ \$116
Fabric/Vinyl Grade 5	FG5/VG5	+ \$116	+ \$172
Fabric/Vinyl Grade 6	FG6/VG6	+ \$159	+ \$213
Fabric/Vinyl Grade 7	FG7/VG7	+ \$200	+ \$254
Leather Grade 1	LG1	+ \$100	+ \$160
COL	COL	+ \$145	+ \$360
Leather Grade 2	LG2	+ \$145	+ \$360
Leather Grade 3	LG3	+ \$200	+ \$550

Ballistic nylon back (NBN) is not available with multi-upholstery (UMU).

Back Upholstery Only	Code	Price	
			Guest/Hip Chair/Stools Midsize/ Bariatric
Fabric/Vinyl Grade 1	FG1/VG1	+ \$0	+ \$0
COM	COM	+ \$18	+ \$22
Fabric/Vinyl Grade 2	FG2/VG2	+ \$18	+ \$22
Fabric/Vinyl Grade 3	FG3/VG3	+ \$39	+ \$45
Fabric/Vinyl Grade 4	FG4/VG4	+ \$63	+ \$77
Fabric/Vinyl Grade 5	FG5/VG5	+ \$91	+ \$116
Fabric/Vinyl Grade 6	FG6/VG6	+ \$123	+ \$159
Fabric/Vinyl Grade 7	FG7/VG7	+ \$154	+ \$200
Leather Grade 1	LG1	+ \$70	+ \$130
COL	COL	+ \$100	+ \$295
Leather Grade 2	LG2	+ \$100	+ \$295
Leather Grade 3	LG3	+ \$140	+ \$450

7. Packaging

Subhead	Code	Price	
Fully Assembled In a Carton	AC	+ \$0	

SPECIFICATIONS

Model: 1191	SW19 Guest Chair	SW26 Midsize Chair	SW30 Bariatric Chair
Dimensions			
Overall Width With Arms	24.75"	31.25"	35.5"
Overall Width Armless	21.25"	N/A	N/A
Overall Depth	23"	23"	23"
Overall Height	33.75"	33.75"	33.75"
Seat Width	18.75"	25.75"	29.5"
Seat Depth	17.5"	17.5"	17.5"
Seat Height	18.25"	18.25"	18.25"
Back Width	19"	27.5"	30"
Back Height	15.75"	15.75"	15.75"
Materials			
COM (Back)	0.75 yd	0.95 yd	1.25 yd
COM (Seat)	0.9 yd	1 yd	1.25 yd
COM (Seat and Back)	1.25 yd	1.75 yd	2 yd
COL (Back)	12 sq ft	15 sq ft	18 sq ft
COL (Seat)	14 sq ft	17 sq ft	21 sq ft
COL (Seat and Back)	21 sq ft	27 sq ft	30 sq ft
Stacking			
Max Cart Stacking	6	N/A	N/A
Max Floor Stacking	4	N/A	N/A
Weight and Capacity			
Weight With Arms	24.5 lb	37 lb	42.5 lb
Weight Armless	23 lb	N/A	N/A
Weight Capacity Warranty	500 lb	600 lb	750 lb

**MULTIPURPOSE CHAIR, BARIATRIC,
COUNTER STOOL AND BAR STOOL**

SPECIFICATIONS

Model: 1191	SW19 S9 Counter Stool	SW19 S2 Bar Stool	SW19 S4 Easy Access Hip Chair
Dimensions			
Overall Width With Arms	24.75"	24.75"	24.75"
Overall Width Armless	21.25"	21.25"	N/A
Overall Depth	23"	23"	23.5"
Overall Height	39.5"	45.5"	39.5"
Seat Width	18.75"	18.75"	18.75"
Seat Depth	18.75"	18.75"	18.75"
Seat Height	24"	30"	24"
Back Width	19"	19"	19"
Back Height	15.75"	15.75"	15.75"
Materials			
COM (Back)	0.75 yd	0.75 yd	0.75 yd
COM (Seat)	0.9 yd	0.9 yd	0.9 yd
COM (Seat and Back)	1.25 yd	1.25 yd	1.25 yd
COL (Back)	12 sq ft	12 sq ft	12 sq ft
COL (Seat)	14 sq ft	14 sq ft	14 sq ft
COL (Seat and Back)	21 sq ft	21 sq ft	21 sq ft
Stacking			
Max Cart Stacking	N/A	N/A	N/A
Max Floor Stacking	N/A	N/A	N/A
Weight and Capacity			
Weight With Arms	35 lb	36 lb	38 lb
Weight Armless	33.5 lb	34.5 lb	N/A
Weight Capacity Warranty	500 lb	500 lb	500 lb



EFFECTIVE
OCTOBER 17, 2022

REPLACEMENT SEATING PARTS

Replacement Parts: Seats

Seat Size	Code	Price	
Guest/Hip Chair/Counter Stool/Bar Stool Seat	SEAT	\$70	
Midback Seat	SEAT	\$85	
Bariatric Seat	SEAT	\$120	
Multi-Upholstery	Code	Price	
Seat Upholstery Only		Guest/Hip Chair/Stools	Midsize/Bariatric
Fabric/Vinyl Grade 1	FG1/VG1	+ \$0	+ \$0
COM	COM	+ \$22	+ \$26
Fabric/Vinyl Grade 2	FG2/VG2	+ \$22	+ \$26
Fabric/Vinyl Grade 3	FG3/VG3	+ \$45	+ \$60
Fabric/Vinyl Grade 4	FG4/VG4	+ \$77	+ \$116
Fabric/Vinyl Grade 5	FG5/VG5	+ \$116	+ \$172
Fabric/Vinyl Grade 6	FG6/VG6	+ \$159	+ \$213
Fabric/Vinyl Grade 7	FG7/VG7	+ \$200	+ \$254
Leather Grade 1	LG1	+ \$100	+ \$160
COL	COL	+ \$145	+ \$360
Leather Grade 2	LG2	+ \$145	+ \$360
Leather Grade 3	LG3	+ \$200	+ \$550

Replacement Parts: Back

Seat Size	Code	Price	
Guest Back	BACK	\$90	
Midback Back	BACK	\$120	
Bariatric Back	BACK	\$160	
Multi-Upholstery	Code	Price	
Back Upholstery Only		Guest/Hip Chair/Stools	Midsize/Bariatric
Fabric/Vinyl Grade 1	FG1/VG1	+ \$0	+ \$0
COM	COM	+ \$18	+ \$22
Fabric/Vinyl Grade 2	FG2/VG2	+ \$18	+ \$22
Fabric/Vinyl Grade 3	FG3/VG3	+ \$39	+ \$45
Fabric/Vinyl Grade 4	FG4/VG4	+ \$63	+ \$77
Fabric/Vinyl Grade 5	FG5/VG5	+ \$91	+ \$116
Fabric/Vinyl Grade 6	FG6/VG6	+ \$123	+ \$159
Fabric/Vinyl Grade 7	FG7/VG7	+ \$154	+ \$200
Leather Grade 1	LG1	+ \$70	+ \$130
COL	COL	+ \$100	+ \$295
Leather Grade 2	LG2	+ \$100	+ \$295
Leather Grade 3	LG3	+ \$140	+ \$450

Focus Side

MULTIPURPOSE CHAIR, COUNTER STOOL AND BAR STOOL

Where comfort, style and ergonomics converge.

The revitalized Focus™ Side combines comfort and design for multi-purpose, office or reception areas. Choose either the 4-leg side chair, bar or counter stools in 3 back options – mesh, upholstered and wood. Two different frame finishes permit it to blend in—or stand out. Focus Side is part of a broad and versatile collection that includes executive and task models. Designed to complement Focus and Amplify task chairs.



Good

EFFECTIVE OCTOBER 17, 2022

Featured Models

GOOD :: \$515

Multipurpose chair, mesh back, upholstered seat, standard multi-surface glides, armless, grade 1 textile

BETTER :: \$573

Multipurpose chair, mesh back, upholstered seat, standard multi-surface glides, arms, grade 1 textile

BEST :: \$738

Multipurpose chair, clear maple slotted wood back, upholstered seat, arms, carpet casters, grade 1 textile

FOCUS SIDE

EFFECTIVE OCTOBER 17, 2022 | GSA SIN #: 33721

Features









- 4-leg side chair, 30" bar and 24" counter stool models
- Three back options: mesh, wood and fully upholstered
- 15 bleach-cleanable mesh back colors
- Two wood back styles and four wood stain finishes
- Black or silver frame
- Upholstered waterfall seat
- Mesh back model stacks four on the floor, five on the optional cart; upholstered back model stacks three on the floor, three on the optional cart
- 300 lb weight capacity warranty
- Complements Focus and Focus 2.0 task chairs and stools; see [page 56](#) and [page 74](#)



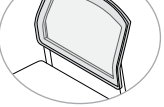

Better

MULTIPURPOSE CHAIR, COUNTER STOOL AND BAR STOOL

1. Frame

Model and Frame Finish	Code	Price	
Chairs			
Black	5651	\$573	
Silver	5652	\$573	
Black With Black Carpet Casters	5641	\$613	
Silver With Black Carpet Casters	5642	\$613	
Stools			
24" Black Counter Stool	5651 S9	\$723	
24" Silver Counter Stool	5652 S9	\$723	
30" Black Bar Stool	5651 S2	\$723	
30" Silver Bar Stool	5652 S2	\$723	

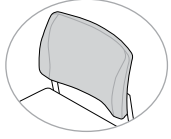

2. Back

Back Style	Code	Price	
Mesh	B1	+ \$0	
Upholstered	B3	+ \$0	
Solid Wood	WB1	+ \$125	
Slotted Wood	WB2	+ \$125	

FOCUS SIDE

EFFECTIVE OCTOBER 17, 2022 | GSA SIN #: 33721

3. Arms

Arm Style	Code	Price	
Armless	A0	- \$58	
Fixed Loop	A130	+ \$0	

4. Base

Casters and Glides	Code	Price	
Casters			

Carpet Casters	C13	+ \$0	
Hard Floor and Carpet Casters	C12	+ \$40	



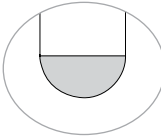
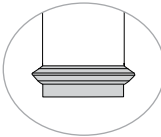
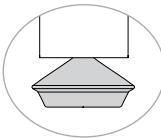
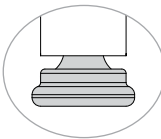

Casters and Glides	Code	Price	
Glides			

Standard Multi-Surface Glides	G5	+ \$0	
Floor Saver Glides	G12	+ \$17	
Performance Multi-Surface Glides	GL2	+ \$17	
Steel Glides (Carpet Only)	G13	+ \$17	

Please use caution when stacking models with casters to prevent frame damage. SitOnIt Seating does not warrant scratched frames. Casters are not available on counter stool (S9) or bar stool (S2).

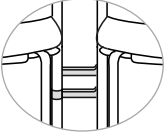
MULTIPURPOSE CHAIR, COUNTER STOOL AND BAR STOOL

5. Miscellaneous

Accessories	Code	Price	
Ganging Bracket for Armless Models	GG11	+ \$30	
Ganging Bracket for Models With Arms	GA11	+ \$30	
Stacking Cart	56-Cart	+ \$324	
Sector Seating Screen	3097 52X	+ \$460	

Ganging brackets and stacking carts are not intended for use with caster models or stools and are compatible with glides only. Wood back chairs (WB1/WB2) are not stackable. See page 594 for additional stacking requirements.

See Sector Seating Screens on page 548 for more specification details.



6. Material

Protection	Code	Price
Fire Retardancy		
CAL 133, Fabric, Quantities 1-49	133F	+ \$99
CAL 133, Fabric, Quantities 50+	133F5	+ \$55
CAL 133, Leather, Any Quantity	133L	+ \$119
Mesh Color (For B1)	Code	Price
Matches Amplify		
Apple	MC31	+ \$0
Aqua	MC30	+ \$0
Desert	MC9	+ \$0
Electric Blue	MC24	+ \$0
Fire	MC10	+ \$0
Fog	MC7	+ \$0
Navy	MC8	+ \$0
Nickel	MC6	+ \$0
Onyx	MC5	+ \$0
Tangerine	MC28	+ \$0
Matches Focus		
Black	MC1	+ \$0
Sand	MC3	+ \$0
Slate	MC2	+ \$0
Freeway Sport Stripe (Black/Slate)	MC33	+ \$0
Impress Sport Stripe (Slate/Black)	MC34	+ \$0
Wood Stain (For WB)	Code	Price
Amber Mahogany	S5	+ \$0
Clear Maple	S1	+ \$0
Espresso	S8	+ \$0
Medium Cherry	S3	+ \$0

MULTIPURPOSE CHAIR, COUNTER STOOL AND BAR STOOL

6. Material (Cont.)

Textile	Code	Price
Seat Only (For B1/WB)		
Fabric/Vinyl Grade 1	FG1/VG1	+ \$0
COM	COM	+ \$22
Fabric/Vinyl Grade 2	FG2/VG2	+ \$22
Fabric/Vinyl Grade 3	FG3/VG3	+ \$45
Fabric/Vinyl Grade 4	FG4/VG4	+ \$77
Fabric/Vinyl Grade 5	FG5/VG5	+ \$116
Fabric/Vinyl Grade 6	FG6/VG6	+ \$159
Fabric/Vinyl Grade 7	FG7/VG7	+ \$200
Leather Grade 1	LG1	+ \$140
COL	COL	+ \$200
Leather Grade 2	LG2	+ \$200
Leather Grade 3	LG3	+ \$280
Seat and Back (For B3)		
Fabric/Vinyl Grade 1	FG1/VG1	+ \$0
COM	COM	+ \$34
Fabric/Vinyl Grade 2	FG2/VG2	+ \$34
Fabric/Vinyl Grade 3	FG3/VG3	+ \$74
Fabric/Vinyl Grade 4	FG4/VG4	+ \$121
Fabric/Vinyl Grade 5	FG5/VG5	+ \$174
Fabric/Vinyl Grade 6	FG6/VG6	+ \$235
Fabric/Vinyl Grade 7	FG7/VG7	+ \$296
Leather Grade 1	LG1	+ \$260
COL	COL	+ \$320
Leather Grade 2	LG2	+ \$320
Leather Grade 3	LG3	+ \$400

Please reference the [Textile Reference Guide](#) for pricing on fabric over grade 7 or leather over grade 3. Additional CAL 133 information can be found on [page 15](#).

Please reference the [Fabric information](#) found on [page 17](#) for pricing on multi-upholstery.

7. Packaging

Packaging	Code	Price
Fully Assembled In a Carton (Chairs)	AC3	+ \$0
Fully Assembled In a Carton, Individually Packed Chairs	AC1	+ \$20
Fully Assembled In a Carton, Individually Packed Stools	AC1	+ \$0

CHAIR SPECIFICATIONS

Model:	5651 / 5652 Side Chair	5641 / 5642 Side Chair with Casters
Dimensions		
Overall Width Armless	20.5"	20.5"
Overall Width With Arms	24.5"	24.5"
Overall Depth	26" (B1/WB) 25"(B3)	26" (B1/WB) 25" (B3)
Overall Height	34"(B1) 32.5" (B3/WB)	34" (B1) 32.5" (B3/WB)
Seat Width	18"	18"
Seat Depth	18.5"	18.5"
Seat Height	18"	18"
Back Width	20.5"	20.5"
Back Height	18"	18"
Materials		
COM	1 yd (B1/WB) 1.25 yd (B3)	1 yd (B1/WB) 1.25 yd (B3)
COL	12 sq ft (B1/WB) 20 sq ft (B3)	12 sq ft (B1/WB) 20 sq ft (B3)
Stacking		
Maximum Cart Stacking	5 (B1 Only) 3 (B3 Only)	5 (B1 Only) 3 (B3 Only)
Maximum Floor Stacking	4 (B1 Only) 3 (B3 Only)	4 (B1 Only) 3 (B3 Only)
Cart Stacking Weight Armless	133.5 lb	Not Recommended
Cart Stacking Weight With Arms	148.5 lb	Not Recommended
Floor Stacking Weight Armless	84 lb	Not Recommended
Floor Stacking Weight With Arms	96 lb	Not Recommended
Weight and Capacity		
Weight Armless	21 lb (B1/B3) 22 lb (WB)	21 lb (B1/B3) 22 lb (WB)
Weight With Arms	24 lb (B1/B3) 25 lb (WB)	24 lb (B1/B3) 25 lb (WB)
Weight Capacity Warranty	300 lb	300 lb

Mesh back (B1). Upholstered back (B3). Wood back (WB).

MULTIPURPOSE CHAIR, COUNTER STOOL AND BAR STOOL

STOOL SPECIFICATIONS

	5651 S9 / 5652 S9 24" Counter Stool	5652 S1 / 5652 S2 30" Bar Stool
Dimensions		
Overall Width Armless	20.5"	20.5"
Overall Width With Arms	24.5"	24.5"
Overall Depth	26" (B1/WB) 25" (B3)	26" (B1/WB) 25" (B3)
Overall Height	39.5" (B1) 37" (B3/WB)	46.5" (B1) 44" (B3/WB)
Seat Width	18"	18"
Seat Depth	18.5"	18.5"
Seat Height	24"	31"
Back Width	20.5"	20.5"
Back Height	18"	18"
Materials		
COM	1 yd (B1/WB) 1.25 yd (B3)	1 yd (B1/WB) 1.25 yd (B3)
COL	17 sq ft (B1/WB) 20 sq ft (B3)	17 sq ft (B1/WB) 20 sq ft (B3)
Weight and Capacity		
Weight Armless	28 lb (B1/B3) 29 lb (WB)	30 lb (B1/B3) 31 lb (WB)
Weight With Arms	31 lb (B1) 32 lb (B3/WB)	33 lb (B1) 34 lb (B3/WB)
Weight Capacity Warranty	300 lb	300 lb

Mesh back (B1). Upholstered back (B3). Wood back (WB).

Freelance

MULTIPURPOSE CHAIR, COUNTER STOOL AND BAR STOOL

Built for durability.

Imagine the versatility.

The transitional design of Freelance side chairs works well in lobby areas, workstations and offices. The comfortable, curved seat and structural integrity has made it a high-demand, multipurpose chair. Three frame/arm finish combinations create variety. Add casters or a book rack for ultimate mobility and flexibility in training rooms and collaborative spaces. Freelance is a broad collection of 4-leg chair, counter and bar stools.



EFFECTIVE OCTOBER 17, 2022

Featured Models

GOOD :: \$459

4-leg chair, all plastic seat and back, arms, standard multi-surface glides

BETTER :: \$496

4-leg chair, upholstered seat and plastic back, arms, standard multi-surface glides, grade 1 textile

BEST :: \$557

4-leg chair, upholstered seat and back, arms, carpet casters, grade 1 textile

Features

- Fully upholstered, upholstered seat or plastic
- Nine plastic colors
- Three frame/arm finish combinations: black and silver/slate.
- Waterfall seat
- Molded shroud underside
- Wall-saver frame design
- Optional book rack
- Stacks four on floor, six on the optional cart
- Weight capacity warranty:
300 lb for all plastic chairs and stools or upholstered chairs with casters;
400 lb for upholstered chairs with glides;
500 lb for Heavy Duty 24/7

1. Back

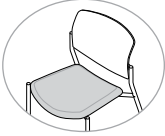
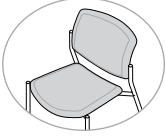
Back and Seat Style	Code	Price	
Plastic	No Code	\$459	
Upholstered Seat	US	\$496	
Upholstered Seat and Back	UP	\$517	

2. Super Duty

Heavy Duty Series	Code	Price	
Heavy Duty	HD	+ \$306	

Heavy Duty option only available on upholstered 4-leg chair frame (521) with glides. See the Super Duty Guide on [page 591](#) for additional high weight capacity models.

MULTIPURPOSE CHAIR, COUNTER STOOL AND BAR STOOL

3. Seat

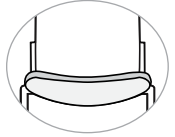
Seat Options	Code	Price	
1" Additional Foam	F1	+ \$36	

4. Frame

Frame Type	Code	Price	
Chairs			

4-Leg Chair	521X	+ \$0	
-------------	------	-------	---

4-Leg Chair With Carpet Casters	522X	+ \$40	
---------------------------------	------	--------	---

Stools			
--------	--	--	--

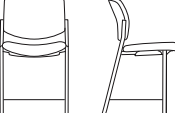
24" Counter Stool	5214 S9	+ \$150	
-------------------	---------	---------	--

30" Bar Stool	5214 S2	+ \$150	
---------------	---------	---------	--

Frame Finish	Code	Price	
--------------	------	-------	--





2-Day Lead Time			
-----------------	--	--	--

Black	FB	+ \$0	
-------	----	-------	--

Silver	FS	+ \$0	
--------	----	-------	--

Arm color will match the frame color unless otherwise specified. "x" = arm or armless; see arms section on the following page.

5. Arms

Arm Style	Code	Price	
For Chairs			
Armless (Append Arm Code to Frame Type Code)	XXX3	- \$58	
Fixed Loop Arms (Append Arm Code to Frame Type Code)	XXX4	+ \$0	
For Stools			
Armless	5213	- \$58	
Fixed Loop Arms	5214	+ \$0	

Arm Color	Code	Price	
2-Day Lead Time			
Black	AC3	+ \$0	
Slate	AC4	+ \$0	

Arm color will match the frame color unless specified otherwise.

6. Base

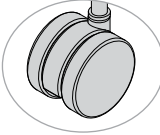
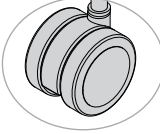
Casters or Glides	Code	Price	
Casters			
Carpet Casters	C13	+ \$0	
Hard Floor and Carpet Casters	C12	+ \$40	

Casters are not available on stool models.

MULTIPURPOSE CHAIR, COUNTER STOOL AND BAR STOOL

6. Base (Cont.)

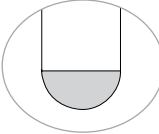
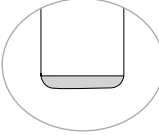
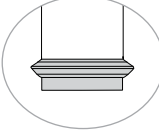
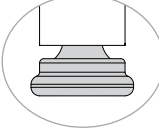

Arm Color	Code	Price	
Glides for 4-Leg Chair (521X/522X) and Stool (S2/S9)			
Standard Multi-Surface Glides	G5	+ \$0	
Performance Multi-Surface Glides	GL2	+ \$17	
Performance Multi-Surface Glides for Heavy Duty Option Only	GL2	+ \$0	
Floor Saver Glides	G12	+ \$17	
Steel Glides (Carpet Only)	G13	+ \$17	

Glides (GL2) are standard for Heavy Duty (HD) option.

Please use caution when stacking models with casters to prevent frame damage. SitOnIt Seating does not warrant scratched frames.

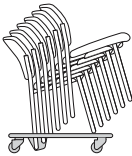
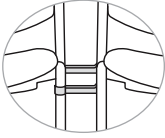

7. Miscellaneous

Accessories	Code	Price	
Book Rack (Black)	BRF	+ \$79	
Stacking Cart	14-Cart	+ \$324	
Ganging Bracket for Armless Models	GG2	+ \$30	
Ganging Bracket for Models With Arms	GA2	+ \$30	
Sector Seating Screen	3097 56X	+ \$460	

Accessories are not compatible with stool models (S2/(S9).

Book rack for 4-leg frame only. Book rack (BRF) and stacking cart (14-cart) are not for use with caster models (522x). See [page 594](#) for additional stacking requirements.

Please use caution when stacking models with casters to prevent frame damage. SitOnIt Seating does not warrant scratched frames.

See Sector Seating Screens on [page 548](#) for additional specification details.

8. Material

Protection	Code	Price	
Fire Retardancy			
CAL 133, Fabric, Quantities 1-49	133F	+ \$99	
CAL 133, Fabric, Quantities 50+	133F5	+ \$55	
CAL 133, Plastic, Any Quantity	133P	+ \$45	
Ballistic Nylon Back			
Ballistic Nylon Back	BN	+ \$0	

MULTIPURPOSE CHAIR, COUNTER STOOL AND BAR STOOL

8. Material (Cont.)

Shell Color	Code	Price	
Arctic	SC21	+ \$0	
Black	SC1	+ \$0	
Chocolate	SC4	+ \$0	
Lagoon	SC15	+ \$0	
Latte	SC20	+ \$0	
Navy	SC5	+ \$0	
Red	SC19	+ \$0	
Slate	SC8	+ \$0	
Sterling	SC18	+ \$0	
Textile			
Seat Only (For US)			
Fabric/Vinyl Grade 1	FG1/VG1	+ \$0	
COM	COM	+ \$22	
Fabric/Vinyl Grade 2	FG2/VG2	+ \$22	
Fabric/Vinyl Grade 3	FG3/VG3	+ \$45	
Fabric/Vinyl Grade 4	FG4/VG4	+ \$77	
Fabric/Vinyl Grade 5	FG5/VG5	+ \$116	
Fabric/Vinyl Grade 6	FG6/VG6	+ \$159	
Fabric/Vinyl Grade 7	FG7/VG7	+ \$200	
Seat and Back (UP)			
Fabric/Vinyl Grade 1	FG1/VG1	+ \$0	
COM	COM	+ \$34	
Fabric/Vinyl Grade 2	FG2/VG2	+ \$34	
Fabric/Vinyl Grade 3	FG3/VG3	+ \$74	
Fabric/Vinyl Grade 4	FG4/VG4	+ \$121	
Fabric/Vinyl Grade 5	FG5/VG5	+ \$174	
Fabric/Vinyl Grade 6	FG6/VG6	+ \$235	
Fabric/Vinyl Grade 7	FG7/VG7	+ \$296	
Leather/Ballistic Grade 1	LG1/BN1	+ \$140	
COL	COL	+ \$249	
Leather/Ballistic Grade 2	LG2/BN2	+ \$249	
Leather/Ballistic Grade 3	LG3/BN3	+ \$321	

Please reference the [Textile Reference Guide](#) for pricing on fabric over grade 7 and leather over grade 3. Additional CAL 133 information can be found on [page 15](#).

Please reference the Fabric information found on [page 17](#) for pricing on multi-upholstery.

9. Packaging

Packaging	Code	Price
Fully Assembled Stools in a Carton	AC	+ \$0
4-Leg Models		
Fully Assembled In a Carton, When 3 Are Ordered	3C	+ \$0
Fully Assembled in a Carton, When 2 Are Ordered	2C	+ \$10
Fully Assembled In a Carton, Individually Packaged	AC1	+ \$20



MULTIPURPOSE CHAIR, COUNTER STOOL AND BAR STOOL

CHAIR SPECIFICATIONS

Model:	5213 / 5214 / 5223 / 5224 4-Leg Chair
Dimensions	
Overall Width Armless	21.5"
Overall Width With Arms	25"
Overall Depth	24"
Overall Height	33.25"
Seat Width	19.5"
Seat Depth	18.5"
Seat Height	17.5"
Back Width	19.5"
Back Height	16"
Materials	
COM	.99 yd (US) .99 yd (US) (BN) 1.25 yd (UP) 1.15 yd (UP) (BN)
COL	15 sq ft (US) 15 sq ft (US) (BN) 25 sq ft (UP) 21 sq ft (UP) (BN)
Stacking	
Max Cart Stacking	6
Max Floor Stacking	4
Weight and Capacity	
Weight Armless	26.5 lb
Weight With Arms	28.5 lb
Weight Armless (3 Pack)	80 lb
Weight With Arms (3 Pack)	86 lb
Weight Capacity Warranty	300 lb (Plastic/US)(UP C12/C13) 400 lb (UP G5/GL2/G12/G13) 500 lb (HD)

Upholstered seat only (US). Upholstered seat and back (UP). Ballistic nylon (BN). Heavy Duty (HD).

FREELANCE

EFFECTIVE OCTOBER 17, 2022 | GSA SIN #: 33721

MULTIPURPOSE CHAIR, COUNTER STOOL AND BAR STOOL

STOOL SPECIFICATIONS

Model:	5213 S9 / 5214 S9 24" Counter Stool	5213 S2 / 5214 S2 30" Bar Stool
Dimensions		
Overall Width Armless	21.5"	21.5"
Overall Width With Arms	25"	25"
Overall Depth	24"	24"
Overall Height	39"	45"
Seat Width	19.5"	19.5"
Seat Depth	18.5"	18.5"
Seat Height	24"	30"
Back Width	19.5"	19.5"
Back Height	16"	16"
Materials		
COM	0.99 yd (US)	0.99 yd (US)
	0.99 yd (US) (BN)	0.99 yd (US) (BN)
	1.25 yd (UP)	1.25 yd (UP)
	1.15 yd (UP) (BN)	1.15 yd (UP) (BN)
COL	15 sq ft (US)	15 sq ft (US)
	15 sq ft (US) (BN)	15 sq ft (US) (BN)
	25 sq ft (UP)	25 sq ft (UP)
	21 sq ft (UP) (BN)	21 sq ft (UP) (BN)
Weight and Capacity		
Weight Armless	24 lb	26 lb
Weight With Arms	26 lb	28 lb
Weight Capacity Warranty	300 lb (Plastic/US/UP)	300 lb (Plastic/US/UP)

Upholstered seat only (US). Upholstered seat and back (UP). Ballistic nylon back (BN).



Stool

Freelance

BARIATRIC CHAIR

Built for durability. Imagine the versatility.

The transitional design of Freelance bariatric side chairs works well in lobby areas and offices. The comfortable, curved seat and structural integrity has made it a high-demand, multipurpose chair. Three frame/arm finish combinations create variety. The Freelance collection is ideal for heavy-duty and bariatric applications.



30" Bariatric

EFFECTIVE OCTOBER 17, 2022

Featured Models

30" BARIATRIC :: \$917

30" bariatric side, performance multi-surface glides, grade 1 textile

42" BARIATRIC :: \$1,334

42" bariatric side, performance multi-surface glides, grade 1 textile

Features

- Three frame/arm finish combinations: black and silver/slate
- Fully upholstered
- Waterfall seat
- Molded shroud underside
- Wall-saver frame design
- 600 lb weight capacity warranty on 30" model;
1,000 lb capacity on 42" model

1. Seat

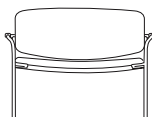
Seat Size	Code	Price	
30" Seat With Arms (600 lb Weight Capacity)	5314	\$917	
42" Seat With Arms (1,000 lb Weight Capacity)	5414	\$1,334	

See the Super Duty Guide on [page 591](#) for additional high weight capacity models.

BARIATRIC CHAIR

2. Frame

Frame Finish	Code	Price	
2-Day Lead Time			
Black	FB	+ \$0	
Silver	FS	+ \$0	

Arm color will match the frame color unless otherwise specified.

3. Base

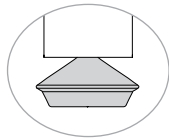
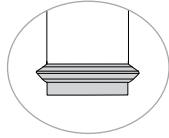
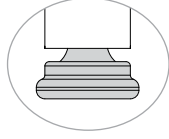
Glides	Code	Price	
Performance Multi-Surface Glides	GL2	+ \$0	
Floor Saver Glides	G12	+ \$17	
Steel Glides (Carpet Only)	G13	+ \$17	



42" Bariatric

4. Arms

Arm Color	Code	Price
Black	AC3	+ \$0
Slate	AC4	+ \$0



Arm color will match the frame color unless otherwise specified.

5. Material

Protection	Code	Price
Fire Retardancy		
CAL 133, Fabric, Quantities 1–49	133F	+ \$99
CAL 133, Fabric, Quantities 50+	133F5	+ \$55
CAL 133, Leather, Any Quantity	133L	+ \$119
Ballistic Nylon Back		
Ballistic Nylon Back	BN	+ \$0
Seat and Back Textile		
Fabric/Vinyl Grade 1	FG1/VG1	+ \$0
COM	COM	+ \$40
Fabric/Vinyl Grade 2	FG2/VG2	+ \$40
Fabric/Vinyl Grade 3	FG3/VG3	+ \$84
Fabric/Vinyl Grade 4	FG4/VG4	+ \$156
Fabric/Vinyl Grade 5	FG5/VG5	+ \$228
Fabric/Vinyl Grade 6	FG6/VG6	+ \$304
Fabric/Vinyl Grade 7	FG7/VG7	+ \$378
Leather Grade 1	LG1	+ \$240
COL	COL	+ \$540
Leather Grade 2	LG2	+ \$540
Leather Grade 3	LG3	+ \$820
Leather/Ballistic Grade 2	BN2	+ \$379
Leather/Ballistic Grade 3	BN3	+ \$631

Please reference the [Textile Reference Guide](#) for pricing on fabric over grade 7 and leather over grade 3. Additional CAL 133 information can be found on [page 15](#).

Please reference the [Fabric information](#) found on [page 17](#) for pricing on multi-upholstery.

BARIATRIC CHAIR

6. Packaging

Packaging	Code	Price
Fully Assembled in a Carton	AC	+ \$0

SPECIFICATIONS

Model:	5314 30" Bariatric Chair	5414 42" Bariatric Chair
Dimensions		
Overall Width With Arms	36.5"	48.5"
Overall Depth	25.5"	25.5"
Overall Height	32.5"	35"
Seat Width	30"	42"
Seat Depth	19"	18"
Seat Height	19"	19"
Back Width	30"	42"
Back Height	16"	16"
Materials		
COM	2.25 yd 1.67 yd (BN)	2.5 yd 1.75 yd (BN)
COL	40 sq ft 30 sq ft (BN)	42 sq ft 40 sq ft (BN)
Weight and Capacity		
Weight With Arms	42.5 lb	62.5 lb
Weight Capacity Warranty	600 lb	1,000 lb

Ballistic nylon (BN).

InFlex

MULTIPURPOSE CHAIR, COUNTER STOOL AND BAR STOOL

Geometry in motion.

Designed by Giancarlo Piretti, this multipurpose, stacking chair offers contemporary styling and spine-friendly comfort—at an affordable price.

Versatile InFlex comes in both plastic stacking side models and upholstered side, task and stool versions. The contemporary styling of this Piretti chair emulates the human spine. Its innovative flex-back disc system, with 13 degrees of back angle range, is as clever as it is comfortable.



EFFECTIVE OCTOBER 17, 2022

Featured Models

GOOD :: \$357

4-leg chair, all plastic seat and back, armless, standard multi-surface glides

BETTER :: \$415

4-leg chair, plastic back, upholstered seat, armless, standard multi-surface glides, grade 1 textile

BEST :: \$531



4-leg chair, upholstered seat and back, fixed cantilever arms, standard multi-surface glides, grade 1 textile

MULTIPURPOSE CHAIR, COUNTER STOOL AND BAR STOOL

Features

- Giancarlo Piretti design
- Innovative disc system emulates the human spine
- Plastic model stack five on the floor, 12 on the optional cart
- Upholstered armless model stack five on the floor; 10 on the optional cart
- Fully upholstered, upholstered seat or plastic
- Nine plastic colors
- Two frame finishes
- 300 lb weight capacity warranty
- Complements InFlex light task chair and stool; see [page 98](#)

1. Back

Seat and Back Style	Code	Price	
Plastic	No Code	\$357	
Upholstered Seat Only	US	\$415	
Upholstered Seat and Back	UP	\$473	

Do not stack upholstered chairs with arms.

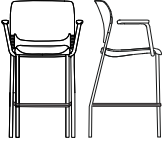

2. Frame

Frame Type	Code	Price	
4-Leg	971	+ \$0	
4-Leg With Black Carpet Casters	974	+ \$40	
24" Counter Stool	971 S9	+ \$150	
30" Bar Stool	971 S2	+ \$150	

Frame Finish	Code	Price	
Black	FC1	+ \$0	
Silver	FC2	+ \$0	

Counter (S9) and bar (S2) stools are available with glides only.

Arms

Arm Style	Code	Price	
Armless	A0	+ \$0	
Fixed Cantilever	A121	+ \$58	

3. Arms (Cont.)

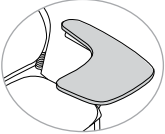
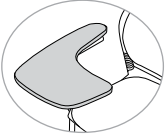
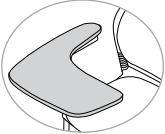
Tablet Arms	Code	Price	
3-Week Lead Time			
Tablet Arm, Left	TLI	+\$156	
Tablet Arm, Right	TRI	+\$156	
Oversized Tablet Arm, Right	TIO	+\$188	
Tablet Laminate Color	Code	Price	
Black	1	+\$0	
Tablet Edge Color	Code	Price	
Black	TE1	+\$0	

Tablet arms are not available with stools or casters. Not stackable. Tablet arms are not available with stools or casters. Not stackable.

4. Base

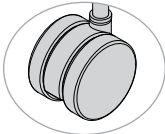
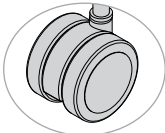
Casters or Glides	Code	Price	
Casters			
Carpet Casters	C13	+\$0	
Hard Floor and Carpet Casters	C12	+\$40	

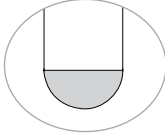
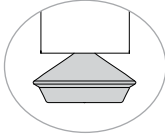
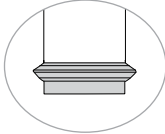
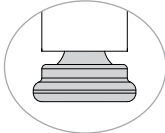

MULTIPURPOSE CHAIR, COUNTER STOOL AND BAR STOOL

4. Base (Cont.)

Casters or Glides (Cont.)	Code	Price	
Glides			
Standard Multi-Surface Glides	G11	+\$0	
Performance Multi-Surface Glides	GL2	+\$17	
Floor Saver Glides	G12	+\$17	
Steel Glides (Carpet Only)	G13	+\$17	

Please use caution when stacking models with casters to prevent frame damage. SitOnIt Seating does not warrant scratched frames.

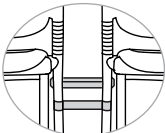
5. Miscellaneous

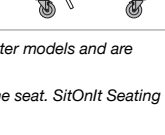
Accessories	Code	Price	
Ganging Bracket for Armless Models	GG9	+\$30	
Ganging Bracket for Models With Arms	GA9	+\$30	
Stacking Cart	97-Cart	+\$399	

Ganging brackets and stacking carts are not intended for use with caster models and are compatible with glides only.

Due to the nature of upholstery, stacking may cause impressions on the seat. SitOnIt Seating does not warrant the effects of stacking on upholstery.

See [page 594](#) for additional stacking requirements.

6. Material

Protection	Code	Price
Fire Retardancy		
CAL 133, Fabric, Quantities 1-49	133F	+ \$99
CAL 133, Fabric, Quantities 50+	133F5	+ \$55
CAL 133, Plastic, Any Quantity	133P	+ \$45
Shell Color (For Plastic and US)	Code	Price
Arctic	SC21	+ \$0
Black	SC1	+ \$0
Chocolate	SC4	+ \$0
Lagoon	SC15	+ \$0
Latte	SC20	+ \$0
Navy	SC5	+ \$0
Red	SC19	+ \$0
Slate	SC8	+ \$0
Sterling	SC18	+ \$0
Textile	Code	Price
Seat Only (For US)		
Fabric/Vinyl Grade 1	FG1/VG1	+ \$0
COM	COM	+ \$22
Fabric/Vinyl Grade 2	FG2/VG2	+ \$22
Fabric/Vinyl Grade 3	FG3/VG3	+ \$45
Fabric/Vinyl Grade 4	FG4/VG4	+ \$77
Fabric/Vinyl Grade 5	FG5/VG5	+ \$116
Fabric/Vinyl Grade 6	FG6/VG6	+ \$159
Fabric/Vinyl Grade 7	FG7/VG7	+ \$200
Seat and Back (For UP)		
Fabric/Vinyl Grade 1	FG1/VG1	+ \$0
COM	COM	+ \$34
Fabric/Vinyl Grade 2	FG2/VG2	+ \$34
Fabric/Vinyl Grade 3	FG3/VG3	+ \$74
Fabric/Vinyl Grade 4	FG4/VG4	+ \$121
Fabric/Vinyl Grade 5	FG5/VG5	+ \$174
Fabric/Vinyl Grade 6	FG6/VG6	+ \$235
Fabric/Vinyl Grade 7	FG7/VG7	+ \$296

Please reference the [Textile Reference Guide](#) for pricing on fabric over grade 7. Additional CAL 133 information can be found on [page 15](#).

Please reference the [Fabric information](#) found on [page 17](#) for pricing on multi-upholstery.

MULTIPURPOSE CHAIR, COUNTER STOOL AND BAR STOOL

7. Packaging

Packaging	Code	Price
Fully Assembled in a Carton	AC4	+ \$0
Fully Assembled Stools in a Carton, Individually Packaged	AC1	+ \$20
Fully Assembled Chairs in a Carton, Individually Packaged	AC1	+ \$20

SPECIFICATIONS

Model:	971 / 974 Multipurpose Chair	971 S9 24" Counter Stool	971 S2 30" Bar Stool
Dimensions			
Overall Width Armless	20"	19.75"	19.75"
Overall Width With Arms	24.125"	25"	25"
Overall Depth	22"	22.25"	22.25"
Overall Height	33"	38.5"	43.5"
Seat Width	17"	16.75"	16.75"
Seat Depth	17"	18.5"	18.5"
Seat Height	18"	24"	29"
Back Width	20"	19.75"	19.75"
Back Height	15.5"	15.5"	15.5"
Materials			
COM	0.85 yd (US) 1 yd (UP)	0.85 yd (US) 1 yd (UP)	0.85 yd (US) 1 yd (UP)
Stacking			
Max Cart Stacking	12 (Plastic) 10 (US/UP)	N/A	N/A
Max Floor Stacking	5	5	5
Weight and Capacity			
Weight Armless	18 lb	22 lb	23 lb
Weight With Arms	22 lb	26 lb	27 lb
Weight Capacity Warranty	300 lb	300 lb	300 lb

Upholstered seat only (US). Upholstered seat and back (UP).

Ioniq

GUEST CHAIR

Inspire unique.

There's a specialness that flows through Ioniq. Its form and feeling are fluid—from the way the arms stretch seamlessly out of a sculpted shell to base options that are as varied and versatile as the spaces they occupy. Because when you desire aesthetics that elevate any experience and offer something refreshingly different, there's only one go-to. And that's Ioniq.



Ioniq Guest

EFFECTIVE OCTOBER 17, 2022

Featured Models

GUEST :: \$899

Plastic back, upholstered seat, integrated arms, 360-degree swivel, 4-star polished aluminum base. standard multi-surface glides, grade 1 textile

Features

- Breathable back with built-in lumbar support
- Minimalist-designed mechanism with streamlined controls
- Edge-to-edge cushion
- Fully integrated armrests
- Single-piece sculpted shell
- 4-star aluminum base
- 300 lb weight capacity warranty
- Complements Ioniq collaborative; see [page 101](#)

1. Frame

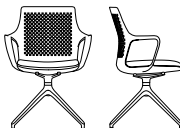
Frame Type	Code	Price	
Guest (4-Star Base)	1152 FT5	\$899	

Seat and Back Style	Code	Price	
Plastic Back With Upholstered Seat Pad	US PB	+ \$0	

Shell Color	Code	Price	
Black	SC1	+ \$0	
White	SC26	+ \$0	

2. Base

Base Type and Material	Code	Price	
4-Star Polished Aluminum	BT5	+ \$0	

Glides	Code	Price	
Standard Multi-Surface Glides	GL1	+ \$0	

3. Mechanism

Mechanism Style	Code	Price	
360-Degree Swivel	FHB	+ \$0	

GUEST CHAIR

4. Material

Seat Textile	Code	Price	
Fabric/Vinyl Grade 1	FG1/VG1	+ \$0	
COM	COM	+ \$22	
Fabric/Vinyl Grade 2	FG2/VG2	+ \$22	
Fabric/Vinyl Grade 3	FG3/VG3	+ \$45	
Fabric/Vinyl Grade 4	FG4/VG4	+ \$77	
Fabric/Vinyl Grade 5	FG5/VG5	+ \$116	
Fabric/Vinyl Grade 6	FG6/VG6	+ \$159	
Fabric/Vinyl Grade 7	FG7/VG7	+ \$200	
Leather Grade 1	LG1	+ \$140	
COL	COL	+ \$200	
Leather Grade 2	LG2	+ \$200	
Leather Grade 3	LG3	+ \$280	

Please reference the [Textile Reference Guide](#) for pricing on fabric over grade 7 and leather over grade 3.

5. Packaging

Packaging	Code	Price	
Back Attached to Seat, Base Separate	UC	+ \$0	
Fully Assembled in a Carton	AC	+ \$120	

SPECIFICATIONS

	1152 FT5 Guest Chair
Dimensions	
Overall Width	28.25"
Overall Depth	28.24"
Overall Height	34.5"
Seat Width	17.5"
Seat Depth	17.38"
Seat Height	18.25"
Back Width	18"
Back Height	17.38"
Materials	
COM	0.75 yd
COL	7 sq ft
Weight and Capacity	
Weight	18.5 lb
Weight Capacity Warranty	300 lb

Chair is widest at the base.

Ioniq

SIDE CHAIR

Inspire unique.

There's a specialness that flows through Ioniq. Its form and feeling are fluid—from the way the arms stretch seamlessly out of a sculpted shell to base options that are as varied and versatile as the spaces they occupy. Because when you desire aesthetics that elevate any experience and offer something refreshingly different, there's only one go-to. And that's Ioniq.



Ioniq Side

EFFECTIVE OCTOBER 17, 2022

Featured Models

SIDE :: \$684

4-leg, chrome finish, plastic back with upholstered seat pad, integrated arms, standard multi-surface glides, grade 1 textile

Features

- Breathable back with built-in lumbar support
- Edge-to-edge cushion
- Fully integrated armrests
- Single-piece sculpted shell
- 4-leg base
- 300 lb weight capacity warranty
- Complements Ioniq collaborative; see [page 86](#)

1. Frame

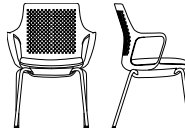
Frame Type	Code	Price	
4-Leg	1151 FT1	\$684	

Frame Finish	Code	Price	
Chrome	FC15	+ \$0	

Do not stack Ioniq side chairs. Frames are not stackable.

2. Seat and Back

Seat and Back Style	Code	Price	
Plastic Back With Upholstered Seat Pad	US PB	+ \$0	

3. Base

Glides	Code	Price	
Standard Multi-Surface Glides	GL1	+ \$0	

SIDE CHAIR

4. Material

Shell Color	Code	Price	
Black	SC1	+ \$0	
White	SC26	+ \$0	
Seat Textile	Code	Price	
Fabric/Vinyl Grade 1	FG1/VG1	+ \$0	
COM	COM	+ \$22	
Fabric/Vinyl Grade 2	FG2/VG2	+ \$22	
Fabric/Vinyl Grade 3	FG3/VG3	+ \$45	
Fabric/Vinyl Grade 4	FG4/VG4	+ \$77	
Fabric/Vinyl Grade 5	FG5/VG5	+ \$116	
Fabric/Vinyl Grade 6	FG6/VG6	+ \$159	
Fabric/Vinyl Grade 7	FG7/VG7	+ \$200	
Leather Grade 1	LG1	+ \$140	
COL	COL	+ \$200	
Leather Grade 2	LG2	+ \$200	
Leather Grade 3	LG3	+ \$280	

Please reference the [Textile Reference Guide](#) for pricing on fabric over grade 7.

5. Packaging

Packaging	Code	Price	
Fully Assembled in a Carton	AC	+ \$0	

One per carton only.

SPECIFICATIONS

Model:	1151 FT1 4-Leg Multipurpose Chair
Dimensions	
Overall Width	23"
Overall Depth	21.38"
Overall Height	32.5"
Seat Width	17.5"
Seat Depth	17.38"
Seat Height	17.63"
Back Width	18"
Back Height	17.38"
Materials	
COM	0.75 yd
COL	7 sq ft
Weight and Capacity	
Weight	15.5 lb
Weight Capacity Warranty	300 lb

Kickstand

STOOL

Lean into work.

Introducing a whole new way to work. There's sitting. There's standing. And now there's perching with Kickstand™. It's an active alternative that provides limitless opportunities for body-benefitting postures, giving you the support you need to lean forward and focus on what's in front of you.



Black

EFFECTIVE OCTOBER 17, 2022

Featured Models

BLACK :: \$591

Black finish, upholstered seat and grade 1 fabric

FOG :: \$610

Fog finish, upholstered seat and grade 1 fabric

Features

- Ergo-sculpted, bolstered seat alleviates pressure points while offering soft, flexible edges
- Customize the cushion with access to thousands of fabrics
- Lightweight frame with easy-grip handle means your new posture is always within reach
- Included auto-return cylinder ensures the seat always faces forward
- Streamlined ambidextrous controls make it easy to adjust from either side for various worksurface heights
- Stable, non-slip base with responsive 360-degree pivoting support keeps you energized and productive
- 250 lb weight capacity warranty

1. Frame

Frame Type	Code	Price
------------	------	-------

Sit-to-Stand Stool	1167	\$591
--------------------	------	-------

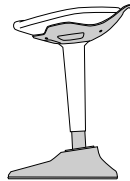

Frame Finish	Code	Price
--------------	------	-------

Black	FC1	+ \$0
Fog	FC13	+ \$19

Frame finish applies to base, column cover and outer seat.

2. Seat

Seat Style	Code	Price
------------	------	-------

Upholstered Seat	US	+ \$0
------------------	----	-------

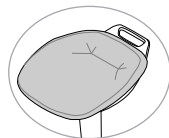

STOOL

3. Base

Stool Kit	Code	Price
-----------	------	-------

Extended Stool Kit	S2	+ \$0
--------------------	----	-------

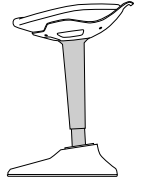

4. Material

Seat Textile	Code	Price
--------------	------	-------

Fabric Grade 1	FG1	+ \$0
COM	COM	+ \$22
Fabric Grade 2	FG2	+ \$22
Fabric Grade 3	FG3	+ \$45
Fabric Grade 4	FG4	+ \$77
Fabric Grade 5	FG5	+ \$116
Fabric Grade 6	FG6	+ \$159
Fabric Grade 7	FG7	+ \$200

Please reference the [Textile Reference Guide](#) for pricing on fabric over grade 7.

To minimize the risk of injury from sliding off Kickstand's forward-tilting seat, SitOnIt Seating does not offer vinyl or leather upholstery options.

5. Packaging

Packaging	Code	Price
-----------	------	-------

Knocked Down - Individually Packaged	KD	+ \$0
--------------------------------------	----	-------

SPECIFICATIONS

Model:	1167 Stool
Dimensions	
Overall Width	15.5"
Overall Depth	18.125"
Overall Height	25.75"-35.875"
Seat Width	15.25"
Seat Depth	15.25"
Seat Height	23.5"-33.75"
Materials	
COM	0.75 yd
Weight	17.5 lb
Weight and Capacity	
Weight Capacity Warranty	250 lb

Lumin

MULTIPURPOSE CHAIR, COUNTER STOOL AND BAR STOOL

Light up the room.

Lumin is an elegant multipurpose stackable chair designed for exceptional support and comfort in corporate and education applications. The contoured seat dissipates pressure points for greater comfort while the perforated back adds contemporary style and comfortable breathability. The Lumin multipurpose stackable chair, counter and bar stools are available in black, silver or chrome frame finish with matching arm pad colors. Refined, sophisticated Lumin will light up the room.



Featured Models

GOOD :: \$325

4-leg chair, plastic seat and back, armless, standard multi-surface glides

BETTER :: \$383

4-leg chair, upholstered seat, armless, standard multi-surface glides, grade 1 textile

BEST :: \$499

4-leg chair, upholstered seat and back, fixed arms, standard multi-surface glides, grade 1 textile

Features

- Contemporary design
- 4-leg and wire rod chair, counter and bar stools
- Exceptional support and comfort
- Fully upholstered, upholstered seat or plastic
- 14 plastic shell colors
- Three frame finishes with matching arm pads
- Left or right folding tablet arm in two finishes
- Built-in pull handle
- Clean-out space
- 4-leg plastic model stacks six on the floor; eight on the optional cart
- Wire frame plastic model stacks eight on the floor; 15 on the optional cart
- 300 lb weight capacity warranty
- Complements Lumin light task chair and stool; see [page 111](#)

1. Frame

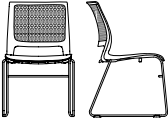
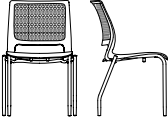
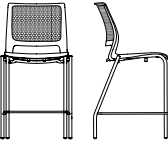
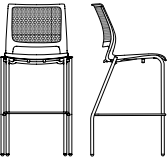
Frame Type	Code	Price	
Wire Rod	1011 FT2	\$302	
4-Leg	1011 FT1	\$325	
24" Counter Stool	1011 FT1 S9	\$475	
30" Bar Stool	1011 FT1 S2	\$475	

Counter (S9) and bar (S2) stools are only available with glides.



MULTIPURPOSE CHAIR, COUNTER STOOL AND BAR STOOL

1. Frame (Cont.)



Frame Finish	Code	Price	
Black	FC1	+ \$0	
Silver (For 4-Leg Frame)	FC2	+ \$0	
Chrome (For Wire Rod Frame)	FC15	+ \$0	

Arms and glides, if specified, are black for black frames and fog for silver or chrome frames.

2. Back

Back and Seat Style	Code	Price	
Plastic Seat	PS	+ \$0	
Upholstered Seat Only	US	+ \$58	
Upholstered Seat and Back	UP	+ \$116	

3. Arms

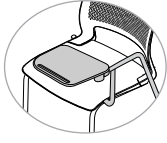
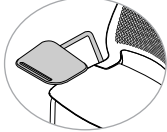
Arm Style	Code	Price	
Armless	A0	+ \$0	
Fixed (For 4-Leg Frame)	A147	+ \$58	
Fixed (For Wire Rod Frame)	A146	+ \$58	
Tablet Arm	Code	Price	
Folding Tablet Arm, Left	RMTL	+ \$156	
Folding Tablet Arm, Right	RMTR	+ \$156	

Tablet arms are not available with stools (S9/S2). Tablet arms are not stackable. Tablet arm will be black for black (FC1) frame or fog for silver (FC2) frame.

4. Base

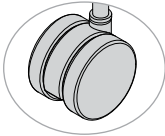
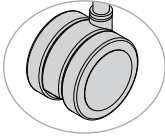
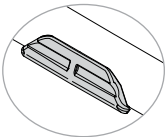
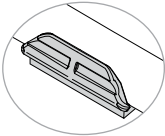
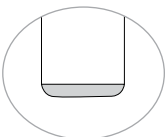
Casters or Glides	Code	Price	
Casters			
Carpet Casters	C13	+ \$40	
Hard Floor and Carpet Casters	C12	+ \$80	
Glides for Wire Rod Frames			
No Glides	G0	+ \$0	
Clear Glides	CGR	+ \$9	
Clear Glides With Felt	CGRF	+ \$22	
Glides for 4-Leg Frames			
Standard Multi-Surface Glides	GL1	+ \$0	
Floor Saver Glides	GL3	+ \$17	
Steel Glides (Carpet Only)	GL4	+ \$17	
Performance Multi-Surface Glides	GL2	+ \$17	

Counter (S9) and bar (S2) stools are only available with glides.

Please use caution when stacking models with casters to prevent frame damage. SitOnIt Seating does not warrant scratched frames.

5. Miscellaneous

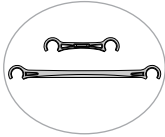
Ganging	Code	Price	
Ganging Bracket for 4-Leg Armless Models	GG10	+ \$30	
Ganging Bracket for 4-Leg Models With Arms	GA10	+ \$30	
Ganging Bracket for Wire Rod Armless Models	GG3	+ \$30	
Ganging Bracket for Wire Rod Models With Arms	GA3	+ \$30	

MULTIPURPOSE CHAIR, COUNTER STOOL AND BAR STOOL

5. Miscellaneous

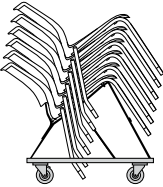
Stacking	Code	Price	
Stacking Cart	1011-CART	+ \$399	

Ganging brackets and stacking carts are not intended for use with caster models and are compatible with glides only. See [page 594](#) for additional stacking requirements.

6. Material

Protection	Code	Price	
Fire Retardancy			
CAL 133, Fabric, Quantities 1-49	133F	+ \$64	
CAL 133, Fabric, Quantities 50+	133F5	+ \$20	
CAL 133, Plastic, Any Quantity	133P	+ \$10	



Best

6. Material (Cont.)

Shell Color	Code	Price
Apple	SC24	+ \$0
Arctic	SC21	+ \$0
Bisque	SC7	+ \$0
Black	SC1	+ \$0
Chocolate	SC4	+ \$0
Lagoon	SC15	+ \$0
Latte	SC20	+ \$0
Lemon	SC25	+ \$0
Navy	SC5	+ \$0
Pacific	SC22	+ \$0
Red	SC19	+ \$0
Slate	SC8	+ \$0
Sterling	SC18	+ \$0
Tangerine	SC23	+ \$0

Textile	Code	Price
Seat Only (For US)		
Fabric/Vinyl Grade 1	FG1/VG1	+ \$0
COM	COM	+ \$22
Fabric/Vinyl Grade 2	FG2/VG2	+ \$22
Fabric/Vinyl Grade 3	FG3/VG3	+ \$45
Fabric/Vinyl Grade 4	FG4/VG4	+ \$77
Fabric/Vinyl Grade 5	FG5/VG5	+ \$116
Fabric/Vinyl Grade 6	FG6/VG6	+ \$159
Fabric/Vinyl Grade 7	FG7/VG7	+ \$200
Seat and Back (For UP)		
Fabric/Vinyl Grade 1	FG1/VG1	+ \$0
COM	COM	+ \$34
Fabric/Vinyl Grade 2	FG2/VG2	+ \$34
Fabric/Vinyl Grade 3	FG3/VG3	+ \$74
Fabric/Vinyl Grade 4	FG4/VG4	+ \$121
Fabric/Vinyl Grade 5	FG5/VG5	+ \$174
Fabric/Vinyl Grade 6	FG6/VG6	+ \$235
Fabric/Vinyl Grade 7	FG7/VG7	+ \$296

Please reference the [Textile Reference Guide](#) for pricing on fabric over grade 7. Additional CAL 133 information can be found on [page 15](#).

Please reference the [Fabric information](#) found on [page 17](#) for pricing on multi-upholstery.

MULTIPURPOSE CHAIR, COUNTER STOOL AND BAR STOOL

7. Packaging

Packaging	Code	Price
Fully Assembled in a Carton	AC	+ \$0
Fully Assembled in a Carton, Individually Packaged	AC1	+ \$20

CHAIR SPECIFICATIONS

Model:	1011 FT1 4-Leg Multipurpose Chair	1011 FT2 Wire Rod Multipurpose Chair
Dimensions		
Overall Width Armless	21.3" (Glides) 22.3" (Casters)	20.7"
Overall Width With Arms	26.8"	24.9"
Overall Depth	22.1"	22.8"
Overall Height	32.9"	32.9"
Seat Width	19"	19"
Seat Depth	18.7"	18.7"
Seat Height	17.3"	17.3"
Back Width	18.3"	18.3"
Back Height	16.7"	16.7"
Materials		
COM	0.85 yd (US) 1 yd (UP)	0.85 yd (US) 1 yd (UP)
Stacking		
Max Cart Stacking	8 (PS), 6 (US/UP)	15 (PS), 6 (US/UP)
Max Floor Stacking	6 (PS), 4 (US/UP)	8 (PS), 4 (US/UP)
Weight and Capacity		
Weight Armless	13 lb (PS), 13.8 lb (US), 14.3 lb (UP)	15 lb (PS), 15.8 lb (US), 16.3 lb (UP)
Weight With Arms	14 lb (PS), 14.8 lb (US), 15.3 lb (UP)	18.5 lb (PS), 19.3 lb (US), 19.8 lb (UP)
Weight Capacity Warranty	300 lb	300 lb

Upholstered seat only (US). Upholstered seat and back (UP).

EFFECTIVE OCTOBER 17, 2022 | GSA SIN #: 33721

STOOL SPECIFICATIONS

Model:	1011 S9 24" Counter Stool	1011 S2 30" Bar Stool
Dimensions		
Overall Width Armless	21.3"	21.3"
Overall Width With Arms	26.8"	26.8"
Overall Depth	22.1"	22.1"
Overall Height	40"	45.1"
Seat Width	19"	19"
Seat Depth	18.7"	18.7"
Seat Height	24.25"	29.5"
Back Width	18.3"	18.3"
Back Height	16.7"	16.7"
Materials		
COM	0.85 yd (US) 1 yd (UP)	0.85 yd (US) 1 yd (UP)
Weight and Capacity		
Weight Armless	17 lb	20.3 lb
Weight With Arms	18.7 lb	21.9 lb
Weight Capacity Warranty	300 lb	300 lb

Upholstered seat only (US). Upholstered seat and back (UP).



Mika

MULTIPURPOSE CHAIR, COUNTER STOOL AND BAR STOOL

Design above.

Mika sits above most others in its class—and not just because it was a multi-award winner. Mika is elevated. Upholstered or non-upholstered, it reaches new heights in what a molded shell chair can be. From top to bottom, the design flows. Back and forth, the design rocks with 15 degrees of flex. Up and up, the design pushes an upholstered seat farther than ever before. And in the end, you arrive at a place of sit-ability and stack-ability hard to find in something that looks this good.



reddot winner 2021



EFFECTIVE OCTOBER 17, 2022

Featured Models

GOOD :: \$385

4-leg, all plastic, armless, standard multi-surface glides

BETTER :: \$461

Wire rod, upholstered seat, armless, no glides, grade 1 textile



BEST :: \$484

4-leg, upholstered seat, armless, standard multi-surface glides, grade 1 textile

Features

- Designed by ITO Design
- Single-piece shell with 15 degrees of backrest flex
- Sculpted shell provides a natural cradle
- Optional $\frac{2}{3}$ upholstered seat available in 15,000+ textiles
- Base options include 4-leg, wire rod, wire rod counter stool and wire rod bar stool
- Three neutral shell colors
- White, black, fog and chrome frame finishes
- Wire rod model stacks up to 30 chairs on a cart
- Upholstered 4-leg model stacks up to nine chairs on the floor
- 300 lb weight capacity warranty

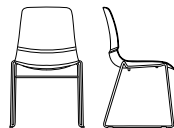
1. Frame

Frame Type	Code	Price	
4-Leg	1101 FT1	\$385	
Wire Rod	1101 FT2	\$362	
24" Wire Rod Counter Stool	1101 FT2 S9	\$512	
30" Wire Rod Bar Stool	1101 FT2 S2	\$512	

MULTIPURPOSE CHAIR AND BAR STOOL

1. Frame

Frame Finish	Code	Price	
For 4-Leg Frame (FT1)			
Black	FC1	+ \$0	
Fog	FC13	+ \$0	
White	FC12	+ \$0	
For Wire Rod Frame (FT2)			
Black	FC1	+ \$0	
Chrome	FC15	+ \$0	

2. Seat

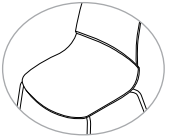
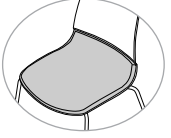
Seat Style	Code	Price	
Plastic Seat	PS	+ \$0	
Upholstered Seat ($\frac{2}{3}$ Upholstered Wrap)	US	+ \$99	



3. Arms

Arm Style	Code	Price	
Armless	AR0	+\$0	

4. Base

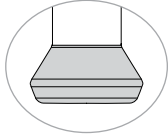
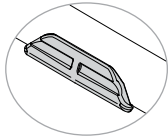
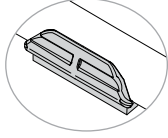
Glides	Code	Price	
For 4-Leg Frame (FT1)			
Standard Multi-Surface Glides	GL1	+\$0	
For Wire Rod Frame (FT2)			
No Glides	G0	+\$0	
Clear Glides	CGR	+\$9	
Clear Glides With Felt	CGRF	+\$22	

5. Miscellaneous

Accessories	Code	Price	
Stacking Cart	CART	+\$399	

Please use caution when stacking to prevent frame damage. SitOnIt Seating does not warrant scratched frames.

Due to the nature of upholstery, stacking may cause impressions on the seat. SitOnIt Seating does not warrant the effects of stacking on upholstery.

Wire rod bar stools (S2) do not stack on cart. See page 594 for additional stacking requirements.

MULTIPURPOSE CHAIR AND BAR STOOL

6. Material

Protection	Code	Price	
Fire Retardancy			
CAL 133, Fabric, Quantities 1-49	133F	+\$64	
CAL 133, Fabric, Quantities 50+	133F5	+\$20	
CAL 133, Plastic, Any Quantity	133P	+\$10	
Shell Color	Code	Price	
Black	SC1	+\$0	
White	SC26	+\$0	
Fog	SC27	+\$0	
Seat Textile (For US)	Code	Price	
Fabric/Vinyl Grade 1	FG1/VG1	+\$0	
COM	COM	+\$22	
Fabric/Vinyl Grade 2	FG2/VG2	+\$22	
Fabric/Vinyl Grade 3	FG3/VG3	+\$45	
Fabric/Vinyl Grade 4	FG4/VG4	+\$77	
Fabric/Vinyl Grade 5	FG5/VG5	+\$116	
Fabric/Vinyl Grade 6	FG6/VG6	+\$159	
Fabric/Vinyl Grade 7	FG7/VG7	+\$200	

Please reference the [Textile Reference Guide](#) for pricing on fabric over grade 7. Additional CAL 133 information can be found on [page 15](#).

7. Packaging

Packaging	Code	Price	
Fully Assembled in a Carton	AC	+\$0	
Fully Assembled in a Carton, Individually Packaged	AC1	+\$20	

CHAIR SPECIFICATIONS

Model:	1101 FT1 4-Leg Chair	1101 FT2 Wire Rod Chair
Dimensions		
Overall Width	22.75"	19.65"
Overall Depth	19.5"	19.5"
Overall Height	32.15"	32.4"
Seat Width	17.5"	17.5"
Seat Depth	16.75"	16.75"
Seat Height	18.5"	18.5"
Back Width	16.25"	16.25"
Back Height	16.25"	16.25"
Materials		
COM	0.85 yd	0.85 yd
Stacking		
Max Floor Stacking	3 (PS) 9 (US)	3 (PS) 6 (US)
Max Cart Stacking	12 (PS) 12 (US)	30 (PS) 12 (US)
Weight and Capacity		
Weight	15 lb	14.5 lb
Weight Capacity Warranty	300 lb	300 lb

Plastic seat (PS). Upholstered seat (US).

STOOL SPECIFICATIONS

Model:	1101 FT2 S9 Wire Rod Counter Stool	1101 FT2 S2 Wire Rod Bar Stool
Dimensions		
Overall Width	21.5"	22"
Overall Depth	20.25"	22.9"
Overall Height	39.5"	45.75"
Seat Width	17.5"	17.5"
Seat Depth	16.75"	16.75"
Seat Height	24.25"	30.25"
Back Width	16.25"	16.25"
Back Height	16.25"	16.25"
Materials		
COM	0.85 yd	0.85 yd
Stacking		
Max Floor Stacking	3 (PS) 3 (US)	3 (PS) 3 (US)
Max Cart Stacking	N/A	N/A
Weight and Capacity		
Weight	18 lb	19.5 lb
Weight Capacity Warranty	300 lb	300 lb

Plastic seat (PS). Upholstered seat (US).

Movi

NESTER CHAIR

Lean back. Nest easy.

Meet the last nester you'll ever need. Whether you're setting up, breaking down or making space for spontaneous collaboration, today's modern workplace calls for high-design seating solutions that can keep up with it all.

Enter Movi: our ultra-lightweight nester with a slim, modern frame and extra flexibility built right in for long-range comfort all day long.



EFFECTIVE OCTOBER 17, 2022

Featured Models

GOOD :: \$739

Mesh back, upholstered seat, black frame and base, armless, casters, grade 1 textile

BETTER :: \$769

Mesh back, upholstered seat, black frame and base, fixed arms, casters, grade 1 textile

BEST :: \$804

Mesh back, upholstered seat, fog frame and base, fixed arms, casters, grade 1 textile

Features

- Compact, 22.75" of depth
- Nests compactly to save space (53% to be exact)
- Flexes at the hip 14-degrees for enhanced comfort
- Caster design and flip-up seat provide easy nesting
- Movement-friendly back & arm support
- Clean-out space for easy maintenance
- Bleach-cleanable mesh back (10:1)
- 12 mesh colors
- Three base frame and caster colors
- Three back frame and arm colors
- Available as an armless option
- Carpet, hard floor and carpet casters available
- 300 lb weight capacity warranty
- Complements Movi light task chair and stool; see [page 118](#)



Best



NESTER CHAIR

1. Frame

Frame Type	Code	Price	
Nesting	1061 FT4 MB	\$769	

Back Frame Finish	Code	Price	
Black	SC1	+ \$0	
Fog	SC27	+ \$35	
White	SC26	+ \$35	

2. Arms

Arm Style	Code	Price	
Armless	AR0	-\$30	
Fixed Loop Arms	AR1	+ \$0	

Arms (AR1) will match back frame color.

3. Base

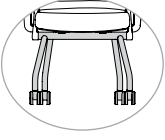
Base Frame and Caster Color	Code	Price	
Black Base With Black Casters	FC1	+ \$0	
Silver Base With Fog Casters	FC2	+ \$0	
White Base With Fog/White Casters	FC12	+ \$0	

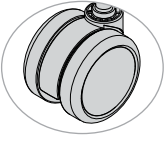
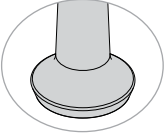
Casters or Glides	Code	Price	
Casters			
Carpet Casters	CS5	+ \$0	
Hard Floor and Carpet Casters	CS6	+ \$40	
Glides			
Bell Glides (Black)	CS20	+\$30	

4. Material

Protection	Code	Price
Fire Retardancy		
CAL 133, Fabric, Quantities 1-49	133F	+ \$99
CAL 133, Fabric, Quantities 50+	133F5	+ \$55

Mesh Color	Code	Price
Apple	MC31	+ \$0
Aqua	MC30	+ \$0
Desert	MC22	+ \$0
Electric Blue	MC24	+ \$0
Fire	MC25	+ \$0
Fog	MC23	+ \$0
Grape	MC26	+ \$0
Lemon	MC27	+ \$0
Nickel	MC21	+ \$0
Ocean	MC29	+ \$0
Onyx	MC20	+ \$0
Tangerine	MC28	+ \$0

Seat Textile	Code	Price
Fabric/Vinyl Grade 1	FG1/VG1	+ \$0
COM	COM	+ \$22
Fabric/Vinyl Grade 2	FG2/VG2	+ \$22
Fabric/Vinyl Grade 3	FG3/VG3	+ \$45
Fabric/Vinyl Grade 4	FG4/VG4	+ \$77
Fabric/Vinyl Grade 5	FG5/VG5	+ \$116
Fabric/Vinyl Grade 6	FG6/VG6	+ \$159
Fabric/Vinyl Grade 7	FG7/VG7	+ \$200

Please reference the [Textile Reference Guide](#) for pricing on fabric over grade 7. Additional CAL 133 information can be found on [page 15](#).

5. Packaging

Packaging	Code	Price
Fully Assembled In a Carton	AC	+ \$0
Fully Assembled In a Carton, Individually Packaged	AC1	+ \$20

NESTER CHAIR

SPECIFICATIONS

Model:	1061 FT4 Nester Chair
Dimensions	
Overall Width With Arms	23"
Overall Width Armless	21"
Overall Depth	22.75"
Overall Height	34.62"
Seat Width	19"
Seat Depth	17"
Seat Height	18"
Back Width	18"
Back Height	18"
Materials	
COM	0.75 yd
Weight and Capacity	
Weight With Arms	20 lb
Weight Armless	19 lb
Weight Capacity Warranty	300 lb

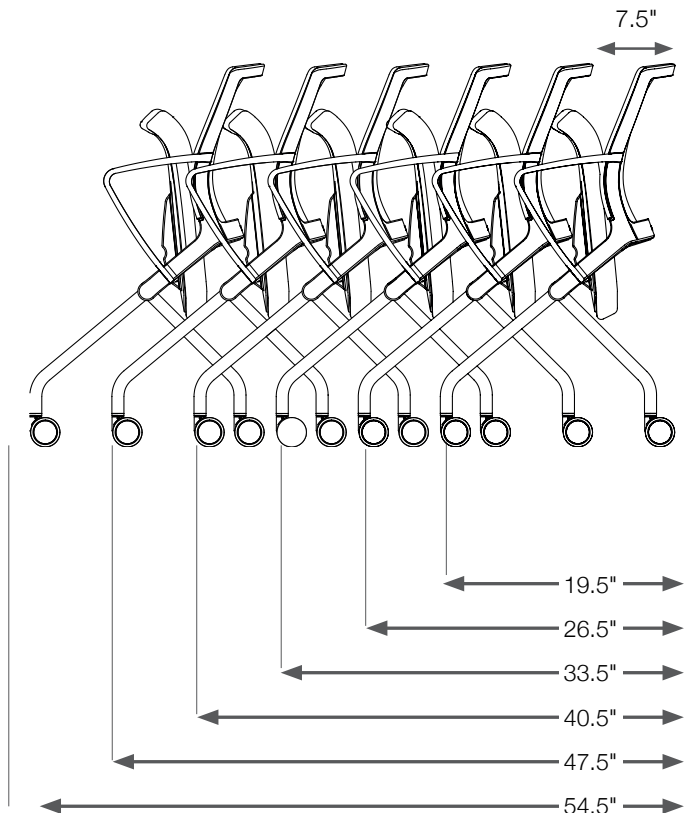

OnCall

MULTIPURPOSE CHAIR AND BAR STOOL

*High performance,
low maintenance.*

Practical, solid wire frame design and stackability make OnCall™ ideal for multipurpose use. It's a value-priced solution for meeting rooms and break areas as well as labs and educational environments. The plastic model offers value while upholstered models ensure a more comfortable sit. A half-circle back cutout serves as a handle to move the side chair or stool anywhere.



Good

EFFECTIVE OCTOBER 17, 2022

Featured Models

GOOD :: \$241

Wire rod chair, all plastic, armless

BETTER :: \$299

Wire rod chair, upholstered seat and plastic back, armless, grade 1 textile



BEST :: \$415

Wire rod chair, upholstered seat and back, fixed arms, grade 1 textile

Features

- Fully upholstered, upholstered seat or plastic
- Three plastic colors
- Black or chrome frame
- Chair stacks eight on the floor, 20-25 on the optional cart; bar stool stacks four on the floor
- Built-in pull handle
- Wall-saver frame design
- 250 lb weight capacity warranty
- Complements OnCall light task chair and stool; see [page 136](#)

1. Back

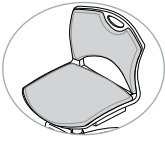
Back and Seat Style	Code	Price	
Plastic	No Code	\$241	
Upholstered Seat Only	US	\$299	
Upholstered Seat and Back	UP	\$357	

2. Frame

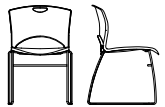
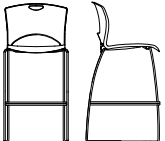

Frame Type	Code	Price	
Wire Rod Side Chair	90	+ \$0	
30" Wire Rod Bar Stool	90 S2	+ \$150	

MULTIPURPOSE CHAIR AND BAR STOOL

2. Frame (Cont.)

Frame Finish	Code	Price	
Black	SB	+ \$0	
Chrome	SC	+ \$0	

3. Arms

Arm Style	Code	Price	
Armless	A0	+ \$0	
Fixed Cantilever	A37	+ \$58	

Fixed cantilever arms (A37) are not available on the bar stool (90 S2).

4. Base

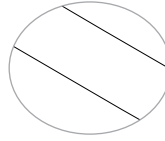
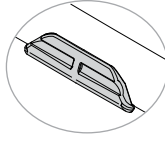
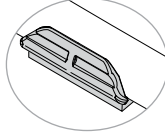
Glides	Code	Price	
No Glides	N	+ \$0	
Clear Glides	CG	+ \$9	
Clear Glides With Felt	CGF	+ \$27	

5. Miscellaneous

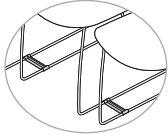
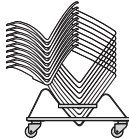
Accessories	Code	Price	
Ganging Bracket for Armless Models	GG3	+ \$12	
Ganging Bracket for Models With Arms	GA3	+ \$12	
Stacking Cart	Cart	+ \$399	

Ganging brackets and stacking carts are not intended for use with wire rod bar stool (S2) models and are compatible with side chair only.

See [page 594](#) for additional stacking requirements.

6. Material

Protection	Code	Price	
Fire Retardancy			
CAL 133, Fabric, Quantities 1-49	133F	+ \$99	
CAL 133, Fabric, Quantities 50+	133F5	+ \$55	
CAL 133, Plastic, Any Quantity	133P	+ \$45	
Shell Color			
Black	SC1	+ \$0	
Navy	SC5	+ \$0	
Slate	SC8	+ \$0	
Textile			
Seat Only (For US)			
Fabric/Vinyl Grade 1	FG1/VG1	+ \$0	
COM	COM	+ \$22	
Fabric/Vinyl Grade 2	FG2/VG2	+ \$22	
Fabric/Vinyl Grade 3	FG3/VG3	+ \$45	
Fabric/Vinyl Grade 4	FG4/VG4	+ \$77	
Fabric/Vinyl Grade 5	FG5/VG5	+ \$116	
Fabric/Vinyl Grade 6	FG6/VG6	+ \$159	
Fabric/Vinyl Grade 7	FG7/VG7	+ \$200	

MULTIPURPOSE CHAIR AND BAR STOOL

6. Material

Textile (Cont.)	Code	Price	
Seat and Back (For UP)			
Fabric/Vinyl Grade 1	FG1/VG1	+ \$0	
COM	COM	+ \$34	
Fabric/Vinyl Grade 2	FG2/VG2	+ \$34	
Fabric/Vinyl Grade 3	FG3/VG3	+ \$74	
Fabric/Vinyl Grade 4	FG4/VG4	+ \$121	
Fabric/Vinyl Grade 5	FG5/VG5	+ \$174	
Fabric/Vinyl Grade 6	FG6/VG6	+ \$235	
Fabric/Vinyl Grade 7	FG7/VG7	+ \$296	

Please reference the [Textile Reference Guide](#) for pricing on fabric over grade 7. Additional CAL 133 information can be found on [page 15](#).

7. Packaging

Packaging	Code	Price	
Fully Assembled Chairs In a Carton	AC4	+ \$0	
Fully Assembled Stools In a Carton	AC4	+ \$0	
Fully Assembled Chairs In a Carton, Individually Packaged	AC1	+ \$20	

An additional charge will apply for each additional chair in the AC1 packaging.



EFFECTIVE OCTOBER 17, 2022 | GSA SIN #: 33721

SPECIFICATIONS

Model:	90 Wire Rod Multipurpose Chair	90 S2 30" Wire Rod Bar Stool
Dimensions		
Overall Width Armless	20"	20"
Overall Width With Arms	24.5"	24.5"
Overall Depth	22.5"	23"
Overall Height	31"	43.5"
Seat Width	18"	18"
Seat Depth	17.5"	17.5"
Seat Height	17.5"	29.5"
Back Width	19.5"	19.5"
Back Height	15"	15"
Materials		
COM	0.8 yd (US) 0.85 yd (UP)	0.8 yd (US) 0.85 yd (UP)
Stacking		
Max Cart Stacking Armless	25 (Plastic) N/A (Upholstered)	N/A
Max Cart Stacking W/with Arms	20 (Plastic) N/A (Upholstered)	N/A
Max Floor Stacking Armless	8 (Plastic) N/A (Upholstered)	4
Max Floor Stacking W/with Arms	8 (Plastic) N/A (Upholstered)	N/A
Weight and Capacity		
Weight Armless	11.4 lb (Plastic) 12.4 lb (US)	21.2 lb (Plastic) 22.2 lb (US)
Weight With Arms	14.2 lb (Plastic) 15.2 lb (US)	N/A
Weight Capacity Warranty	250 lb	250 lb

Upholstered seat only (US). Upholstered seat and back (UP). Stacking upholstered



Orbix

MULTIPURPOSE CHAIR AND BAR STOOL

Everything you need (and more).

More design in a stacker. More comfort in a sit. More models to match the needs of any space. The robust build of Orbix® features an ultra-supportive and extra-wide backrest with hundreds of diamond-cut perforations for unmatched breathability and the comfort to breeze through safe and distanced get-togethers. It sets up quickly, stacks up easily, and stores away conveniently.



Good

Featured Models

GOOD :: \$227

Multipurpose chair, plastic seat and back, armless, no glides

BETTER :: \$294

Multipurpose chair, upholstered seat, plastic back, armless, clear glides, grade 1 textile



BEST :: \$365

Multipurpose chair, upholstered seat, plastic back, fixed arms, clear glides with felt, grade 1 textile

Features

- Consistent, cohesive look with a broad statement of line offers options to fit any space
- Upscale stacking chair with bold lines and striking detail
- Ultra-supportive, extra-wide backrest provides lasting comfort
- Hundreds of diamond-cut perforations offer unmatched breathability and visual transparency
- Integrated clean-out makes it easy to wipe down, set up, stack and store away
- Collection options include wire rod, bar stool, light task chair and stool; see [page 140](#) for Orbix light task chair and stool;
- Plastic wire rod stacks six on the floor (25 on a cart); plastic bar stool stacks six on the floor
- Black or chrome frame finish and 14 shell colors coordinate with optional arm pads and upholstered seat

1. Frame

Frame Type	Code	Price	
Wire Rod Chair	1131 FT2	\$227	
30" Bar Stool	1131 FT2 S2	\$377	
Frame Type	Code	Price	
Black	FC1	+\$0	
Chrome	FC15	+\$0	

MULTIPURPOSE CHAIR AND BAR STOOL

2. Seat and Back

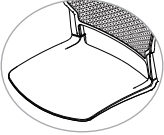
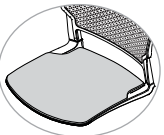
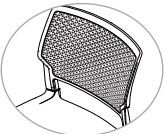
Seat Style	Code	Price	
Plastic	PS	+\$0	
Upholstered	US	+\$58	
Back Style	Code	Price	
Plastic	PB	+\$0	

Do not stack upholstered chairs.

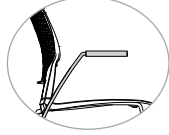

3. Arms

Arm Style	Code	Price	
Armless	AR0	+ \$0	
Fixed	AR1	+ \$58	

Available on wire rod chairs only.

4. Base

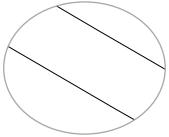
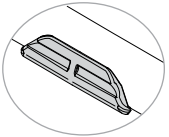
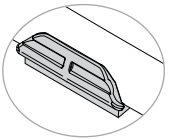
Glides	Code	Price	
No Glides	G0	+\$0	
Clear Glides	CGR	+\$9	
Clear Glides With Felt	CGRF	+\$22	

5. Miscellaneous

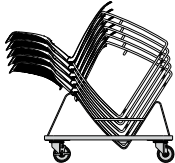
Accessories	Code	Price	
Ganging Bracket for Armless Models	GG	+\$12	
Ganging Bracket for Models With Arms	GA	+\$12	
Stacking Cart	CART	+\$399	

See [page 594](#) for additional stacking requirements.

MULTIPURPOSE CHAIR AND BAR STOOL

6. Material

Shell Color	Code	Price	
Apple	SC24	+ \$0	
Arctic	SC21	+ \$0	
Bisque	SC7	+ \$0	
Black	SC1	+ \$0	
Chocolate	SC4	+ \$0	
Latte	SC20	+ \$0	
Lagoon	SC15	+ \$0	
Lemon	SC25	+ \$0	
Navy	SC5	+ \$0	
Pacific	SC22	+ \$0	
Red	SC19	+ \$0	
Slate	SC8	+ \$0	
Sterling	SC18	+ \$0	
Tangerine	SC23	+ \$0	

Seat Textile	Code	Price	
Fabric/Vinyl Grade 1	FG1/VG1	+ \$0	
COM	COM	+\$22	
Fabric/Vinyl Grade 2	FG2/VG2	+\$22	
Fabric/Vinyl Grade 3	FG3/VG3	+\$45	
Fabric/Vinyl Grade 4	FG4/VG4	+\$77	
Fabric/Vinyl Grade 5	FG5/VG5	+\$116	
Fabric/Vinyl Grade 6	FG6/VG6	+\$159	
Fabric/Vinyl Grade 7	FG7/VG7	+\$200	

7. Packaging

Packaging	Code	Price	
Fully Assembled In a Carton	AC	+ \$0	
Fully Assembled In a Carton, Individually Packaged	AC1	+ \$20	

EFFECTIVE OCTOBER 17, 2022 | GSA SIN #: 33721

SPECIFICATIONS

	1131 FT2 Wire Rod Chair	1131 FT2 S2 Bar Stool
Dimensions		
Overall Width Armless	20"	20"
Overall Width With Arms	24.75"	N/A
Overall Depth	21.75"	22.5"
Overall Height	33.25"	45.5"
Seat Width	18.25"	18.25"
Seat Depth	17.25"	17.25"
Seat Height	18"	30"
Back Width	19.75"	19.75"
Back Height	17.5"	17.5"
Materials		
COM	0.75 yd	0.75 yd
Stacking		
Max Cart Stacking	25 (PS)	N/A
Max Floor Stacking	6 (PS)	6 (PS)
Weight and Capacity		
Weight Armless	13 lb (PS) 14 lb (US)	21 lb (PS) 22 lb (US)
Weight With Arms	16 lb (PS) 17 lb (US)	N/A
Weight Capacity Warranty	300 lb	300 lb

Plastic seat (PS). Upholstered seat (US).



Better

Qwiz

NESTER CHAIR

Nest brilliantly.

From classrooms to training rooms, the need to get in groups can pop up without warning – and Qwiz® is the perfect answer. It's a smart, fun and versatile nester that makes coming together for collaboration or leaving the room with inspiration quick, easy and comfortable.



EFFECTIVE OCTOBER 17, 2022

Featured Models

PLASTIC :: \$496

Plastic seat and back, armless, black shell and frame, carpet casters

MESH :: \$597

Upholstered seat, mesh back, armless, white shell and frame, carpet casters, grade 1 textile

UPHOLSTERED :: \$627

Upholstered seat and back, fog shell and frame, fixed arms, carpet casters, grade 1 textile

Features

- Caster design and flip-up seat for high-density nesting
- Perforated seat and back for breathability
- Three shell and frame colors
- 12 bleach-cleanable mesh back colors
- Upholstered seat or fully upholstered
- Interlocking system for easy ganging
- Available as an armless option
- Performance casters and standard multi-surface glides available
- 300 lb weight capacity warranty

1. Frame

Frame Type	Code	Price	
Nesting	1141 FT4	\$526	

Shell and Frame Finish	Code	Price	
Black	SC1	+ \$0	
Fog	SC27	+ \$35	
White	SC26	+ \$35	

2. Seat

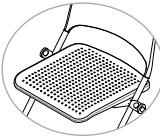
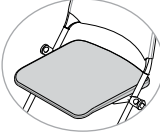
Seat Style	Code	Price	
Plastic Seat	PS	+ \$0	
Upholstered Seat	US	+ \$33	

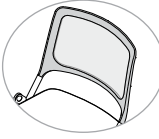
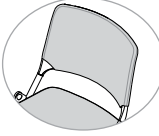

NESTER CHAIR

3. Back

Back Style	Code	Price	
Plastic Back	PB	+ \$0	
Mesh Back	MB	+ \$33	
Upholstered Back	UB	+ \$33	

Upholstered back (UB) is only available with upholstered seat (US).

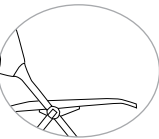
4. Arms

Arm Style	Code	Price	
Armless	AR0	- \$30	
Fixed	AR1	+ \$0	

Arm caps will match shell color.

5. Base

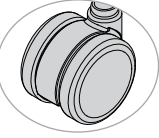
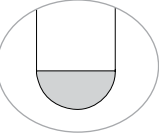
Casters or Glides	Code	Price	
Casters			
Carpet Casters	CS5	+ \$0	
Hard Floor and Carpet Casters	CS6	+ \$40	
Glides			
Standard Multi-Surface Glides	GL1	+ \$30	

Casters, glides and interlock system are black for black shell and frame (SC1) and fog for both fog (SC27) or white (SC26) shells and frames.

6. Material

Mesh Color (For MB)	Code	Price	
Apple	MC31	+ \$0	
Aqua	MC30	+ \$0	
Desert	MC22	+ \$0	
Electric Blue	MC24	+ \$0	
Fire	MC25	+ \$0	
Fog	MC23	+ \$0	
Grape	MC26	+ \$0	
Lemon	MC27	+ \$0	
Nickel	MC21	+ \$0	
Ocean	MC29	+ \$0	
Onyx	MC20	+ \$0	
Tangerine	MC28	+ \$0	
Protection	Code	Price	
Fire Retardancy			
CAL 133, Fabric, Quantities 1-49	133F	+ \$64	
CAL 133, Fabric, Quantities 50+	133F5	+ \$20	
CAL 133, Plastic, Any Quantity	133P	+ \$10	

Additional CAL 133 information can be found on [page 15](#).



Plastic

NESTER CHAIR

6. Material (Cont.)

Textile	Code	Price	
Seat Only (For US)			
Fabric/Vinyl Grade 1	FG1/VG1	+ \$0	
COM	COM	+ \$22	
Fabric/Vinyl Grade 2	FG2/VG2	+ \$22	
Fabric/Vinyl Grade 3	FG3/VG3	+ \$45	
Fabric/Vinyl Grade 4	FG4/VG4	+ \$77	
Fabric/Vinyl Grade 5	FG5/VG5	+ \$116	
Fabric/Vinyl Grade 6	FG6/VG6	+ \$159	
Fabric/Vinyl Grade 7	FG7/VG7	+ \$200	
Seat and Back (For UB)			
Fabric/Vinyl Grade 1	FG1/VG1	+ \$0	
COM	COM	+ \$34	
Fabric/Vinyl Grade 2	FG2/VG2	+ \$34	
Fabric/Vinyl Grade 3	FG3/VG3	+ \$74	
Fabric/Vinyl Grade 4	FG4/VG4	+ \$121	
Fabric/Vinyl Grade 5	FG5/VG5	+ \$174	
Fabric/Vinyl Grade 6	FG6/VG6	+ \$235	
Fabric/Vinyl Grade 7	FG7/VG7	+ \$296	

Please reference the [Textile Reference Guide](#) for pricing on fabric over grade 7.

Due to the nature of vinyl upholstery, nesting may cause impressions on the seat. SitOnIt Seating does not warrant the effects of nesting on vinyl upholstery.

7. Packaging

Packaging	Code	Price	
Fully Assembled In a Carton	AC	+ \$0	
Fully Assembled In a Carton, Individually Packaged	AC1	+ \$20	

EFFECTIVE OCTOBER 17, 2022 | GSA SIN #: 33721

SPECIFICATIONS

Model:	1141 FT4 Nester
Dimensions	
Overall Width With Arms	22"
Overall Width Armless	22"
Overall Depth	22.5"
Overall Height	32"
Seat Width	16.4"
Seat Depth	17"
Seat Height	17.75" (PS) 18" (US/UB)
Back Width	18.5"
Back Height	15"
Arm Height	25.5"
Materials	
COM	0.75 yd (US) 1 yd (US/UB)
Weight and Capacity	
Weight With Arms	15 lb
Weight Armless	13 lb
Weight Capacity Warranty	300 lb

Plastic seat (PS). Upholstered seat only (US). Upholstered seat and back (US/UB).

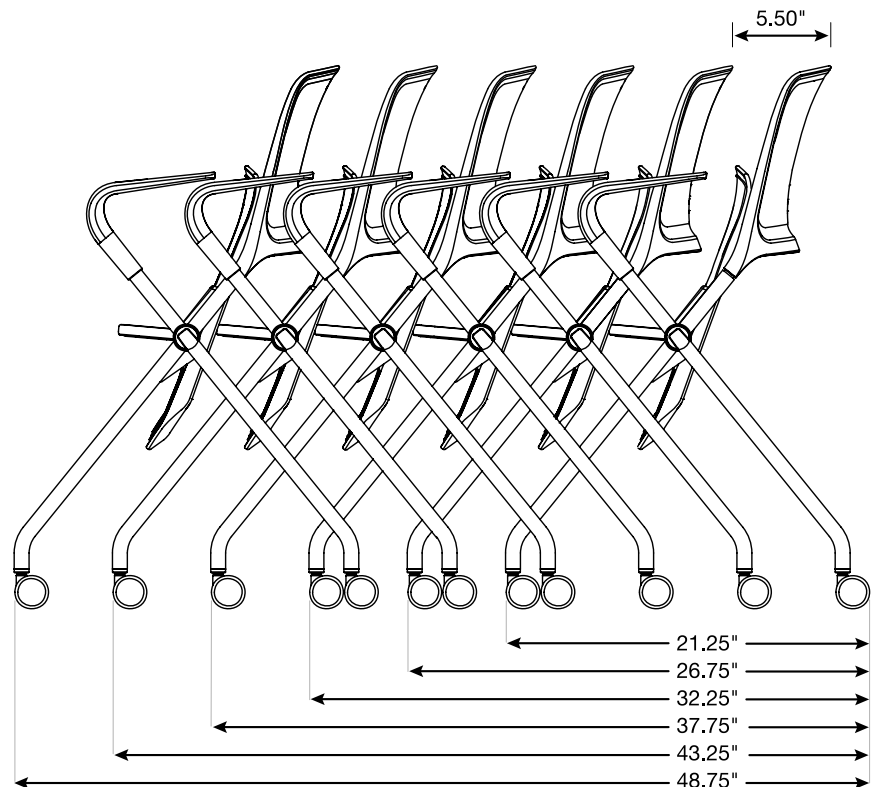

Relay

MULTIPURPOSE CHAIR

Durable and adaptable to the finish.

Great to look at, Relay provides lasting comfort in a stylish design that makes an appealing multipurpose seating option for meeting, training, conference and break rooms. The seat and back are molded from high-impact thermoplastic for lasting durability and comfort. Add the optional upholstered seat and back for a more sophisticated, inviting look and added comfort. Relay side chairs are available in black or silver frame with a caster option.



EFFECTIVE OCTOBER 17, 2022

Featured Models

GOOD :: \$390

All plastic, armless, standard multi-surface glides

BETTER :: \$448

Plastic back, upholstered seat, armless, standard multi-surface glides, grade 1 textile

BEST :: \$604

Upholstered seat and back, fixed cantilever arms, casters, grade 1 textile

Features

- Structurally reinforced and durable back
- High-impact polypropylene
- Fully upholstered, upholstered seat or plastic
- Nine plastic colors
- 4-leg frame
- Armless or with fixed cantilever arms
- Stacks five on the floor, five on the optional cart
- Black or silver frame
- Wall-saver frame design
- 250 lb weight capacity warranty
- Complements Relay light task chair and stool; see [page 156](#)

1. Back

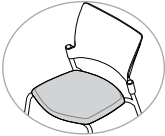
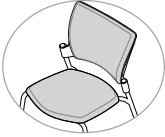

Back and Seat Style	Code	Price	
Plastic	No Code	\$390	
Upholstered Seat Only	US	\$448	
Upholstered Seat and Back	UP	\$506	

MULTIPURPOSE CHAIR

2. Frame

Frame Type and Finish	Code	Price	
Black, 4-Leg	94FB	+ \$0	
Silver, 4-Leg	94FS	+ \$0	
Black, 4-Leg With Black Carpet Casters	94FCB	+ \$40	
Silver, 4-Leg With Black Carpet Casters	94FCS	+ \$40	

3. Arms

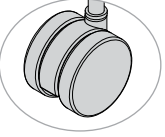
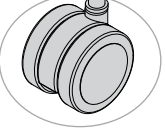
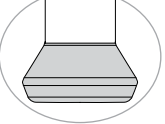

Arm Style	Code	Price	
Armless	A0	+ \$0	
Fixed Cantilever	A60	+ \$58	

4. Base

Casters or Glides	Code	Price	
Casters (For 94FCB / 94FCS)			
Carpet Casters	C13	+ \$0	
Hard Floor and Carpet Casters	C12	+ \$40	
Glides (For 94FB / 94FS)			
Standard Multi-Surface Glides	G9	+ \$0	

Please use caution when stacking models with casters to prevent frame damage. SitOnIt Seating does not warrant scratched frames.

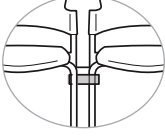
5. Miscellaneous

Accessories	Code	Price	
Ganging Bracket for Armless Models	GG2	+ \$28	
Ganging Bracket for Models With Arms	GA2	+ \$28	
Stacking Cart	14-Cart	+ \$324	

Ganging brackets and stacking carts are not intended for use with caster models and are compatible with glides only. See page 594 for additional stacking requirements.

Due to the nature of upholstery, stacking may cause impressions on the seat. SitOnIt Seating does not warrant the effects of stacking on upholstery.

6. Material

Protection	Code	Price	
Fire Retardancy			
CAL 133, Fabric, Quantities 1-49	133F	+ \$99	
CAL 133, Fabric, Quantities 50+	133F5	+ \$55	
CAL 133, Plastic, Any Quantity	133P	+ \$45	
Shell Color	Code	Price	
Arctic	SC21	+ \$0	
Black	SC1	+ \$0	
Chocolate	SC4	+ \$0	
Lagoon	SC15	+ \$0	
Latte	SC20	+ \$0	
Navy	SC5	+ \$0	
Red	SC19	+ \$0	
Slate	SC8	+ \$0	
Sterling	SC18	+ \$0	
Textile	Code	Price	
Seat Only (US)			
Fabric/Vinyl Grade 1	FG1/VG1	+ \$0	
COM	COM	+ \$22	
Fabric/Vinyl Grade 2	FG2/VG2	+ \$22	
Fabric/Vinyl Grade 3	FG3/VG3	+ \$45	
Fabric/Vinyl Grade 4	FG4/VG4	+ \$77	
Fabric/Vinyl Grade 5	FG5/VG5	+ \$116	
Fabric/Vinyl Grade 6	FG6/VG6	+ \$159	
Fabric/Vinyl Grade 7	FG7/VG7	+ \$200	

MULTIPURPOSE CHAIR

6. Material (Cont.)

Textile	Code	Price	
Seat and Back (UP)			
Fabric/Vinyl Grade 1	FG1/VG1	+ \$0	
COM	COM	+ \$34	
Fabric/Vinyl Grade 2	FG2/VG2	+ \$34	
Fabric/Vinyl Grade 3	FG3/VG3	+ \$74	
Fabric/Vinyl Grade 4	FG4/VG4	+ \$121	
Fabric/Vinyl Grade 5	FG5/VG5	+ \$174	
Fabric/Vinyl Grade 6	FG6/VG6	+ \$235	
Fabric/Vinyl Grade 7	FG7/VG7	+ \$296	

Please reference the [Textile Reference Guide](#) for pricing on fabric over grade 7.

7. Packaging

Packaging	Code	Price	
Fully Assembled in Carton	AC4	+ \$0	
Individually Packaged	AC1	+ \$20	

SPECIFICATIONS

Model:	94F 4-Leg Multipurpose Chair	94FC 4-Leg Multipurpose Chair With Casters
Dimensions		
Overall Width Armless	21.125"	21.125"
Overall Width With Arms	25.75"	25.75"
Overall Depth	22"	22"
Overall Height	33.5"	33.5"
Seat Width	18.25"	18.25"
Seat Depth	17"	17"
Seat Height	18" (Plastic) 19" (US/UP)	18" (Plastic) 19" (US/UP)
Back Width	19.125"	19.125"
Back Height	17"	17"
Materials		
COM	0.75 yd (US) 1 yd (UP)	0.75 yd (US) 1 yd (UP)
Stacking		
Max Cart Stacking	5	N/A
Max Floor Stacking	5	N/A
Weight and Capacity		
Weight Armless	13.5 lb	14 lb
Weight With Arms	14.5 lb	15 lb
Weight Capacity Warranty	250 lb	250 lb

Upholstered seat only (US). Upholstered seat and back (UP).

Relay

NESTER CHAIR

Durable and adaptable to the finish.

Great to look at, Relay provides lasting comfort in a stylish design that makes an appealing multipurpose seating option for meeting, training, conference and break rooms. The seat and back are molded from high-impact thermoplastic for lasting durability and comfort. Add the optional upholstered seat and back for a more sophisticated, inviting look and added comfort. Relay nesting chairs are available in black or silver frame and come with casters standard.



Featured Models

GOOD :: \$429

All plastic, armless, casters

BETTER :: \$487

Plastic back, upholstered seat, armless, casters, grade 1 textile



BEST :: \$603

Upholstered seat and back, fixed cantilever arms, casters, grade 1 textile

Features

- Structurally reinforced and durable back
- High-impact polypropylene
- Fully upholstered, upholstered seat or plastic
- Nine plastic colors
- Armless or with fixed cantilever arms
- Black or silver frame
- 17 chairs in 10 feet of space
- Wall-saver frame design
- 250 lb weight capacity
- Complements Relay light task chair and stool; see [page 156](#)

1. Back



Back and Seat Style	Code	Price	
Plastic	No Code	\$429	
Upholstered Seat Only	US	\$487	
Upholstered Seat and Back	UP	\$545	

2. Frame

Frame Finish	Code	Price	
Black With Black Carpet Casters	94XB	+\$0	
Silver With Black Carpet Casters	94XS	+\$0	

NESTER CHAIR

3. Arms

Arm Style	Code	Price	
Armless	A0	+\$0	
Fixed Cantilever	A60	+\$58	

4. Base

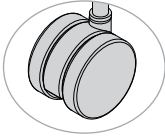
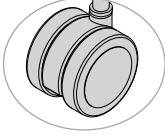
Casters	Code	Price	
Black Carpet Casters	C13	+\$0	
Hard Floor and Carpet Casters	C12	+\$40	

5. Miscellaneous

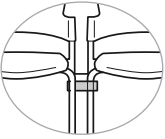
Accessories	Code	Price	
Ganging Bracket for Nester Models	GA10	+\$28	

6. Material

Protection	Code	Price
Fire Retardancy		
CAL 133, Fabric, Quantities 1-49	133F	+ \$99
CAL 133, Fabric, Quantities 50+	133F5	+ \$55
CAL 133, Plastic, Any Quantity	133P	+ \$45
Shell Color	Code	Price
Arctic	SC21	+ \$0
Black	SC1	+ \$0
Chocolate	SC4	+ \$0
Lagoon	SC15	+ \$0
Latte	SC20	+ \$0
Navy	SC5	+ \$0
Red	SC19	+ \$0
Slate	SC8	+ \$0
Sterling	SC18	+ \$0
Textile	Code	Price
Seat Only (US)		
Fabric/Vinyl Grade 1	FG1/VG1	+ \$0
COM	COM	+ \$22
Fabric/Vinyl Grade 2	FG2/VG2	+ \$22
Fabric/Vinyl Grade 3	FG3/VG3	+ \$45
Fabric/Vinyl Grade 4	FG4/VG4	+ \$77
Fabric/Vinyl Grade 5	FG5/VG5	+ \$116
Fabric/Vinyl Grade 6	FG6/VG6	+ \$159
Fabric/Vinyl Grade 7	FG7/VG7	+ \$200
Seat and Back (UP)		
Fabric/Vinyl Grade 1	FG1/VG1	+ \$0
COM	COM	+ \$34
Fabric/Vinyl Grade 2	FG2/VG2	+ \$34
Fabric/Vinyl Grade 3	FG3/VG3	+ \$74
Fabric/Vinyl Grade 4	FG4/VG4	+ \$121
Fabric/Vinyl Grade 5	FG5/VG5	+ \$174
Fabric/Vinyl Grade 6	FG6/VG6	+ \$235
Fabric/Vinyl Grade 7	FG7/VG7	+ \$296

Please reference the [Textile Reference Guide](#) for pricing on fabric over grade 7.

Please reference the [Fabric information](#) found on [page 17](#) for pricing on multi-upholstery.

NESTER CHAIR

7. Packaging

Packaging	Code	Price
Fully Assembled in a Carton	AC4	+ \$0
Fully Assembled in a Carton, Individually Packaged	AC1	+ \$20

SPECIFICATIONS

	94X Nester Chair
Dimensions	
Overall Width Armless	24"
Overall Width With Arms	25.75"
Overall Depth	25.25"
Overall Height	33.5"
Seat Width	18.25"
Seat Depth	17.25"
Seat Height	18.5" (Plastic) 19.5" (US/UP)
Back Width	19.125"
Back Height	17"
Weight Armless	21.5 lb
Weight With Arms	22.5 lb
Materials	
COM	0.75 yd (US) 1 yd (UP)
Weight and Capacity	
Weight Armless	21.5 lb
Weight With Arms	22.5 lb
Weight Capacity Warranty	250 lb

Upholstered seat only (US). Upholstered seat and back (UP).

Rio

MULTIPURPOSE CHAIR, COUNTER STOOL AND BAR STOOL

Design that responds to you.

What goes into the award-winning line of Rio® plastic chairs? Patented flexing technology, for one. Our complete family of Rio models feature our patented Active Rebound Control (ARC) Technology®—a performance-minded flexor insert that supports a wide range of motion (20 full degrees to be exact) and responds precisely to the amount of weight pressed against it.

Add a fresh, modern color palette and you've got a seating solution that allows for more movement, day-long comfort and flexibility than any other chair in its class.

The Rio is an easy choice for multi-use spaces that require quick setups and breakdowns. Discover a collection of stackable chairs engineered to allow for better movement, applications across more environments and a longer product life.



EFFECTIVE OCTOBER 17, 2022

Featured Models

GOOD :: \$290

4-leg chair, plastic seat and back, armless, standard multi-surface glides

BETTER :: \$348

4-leg chair, plastic back, upholstered seat, armless, standard multi-surface glides, grade 1 textile





BEST :: \$464

4-leg chair, upholstered seat and back, fixed arms, standard multi-surface glides, grade 1 textile

Features

- 4-leg, wire rod, 24" counter or 30" bar stool
- Exceptional support and comfort
- Fully upholstered, upholstered seat or plastic
- ARC Technology® for weight-assisted flex
- 14 plastic shell colors
- All models offer two frame finishes with matching arm pads
- Left or right folding tablet arm that match the frame finish.
- Easy-grip edge that acts as pull handle
- Clean-out space
- 4-Leg plastic model stacks four on the floor; eight on the optional cart
- Plastic wire rod model stacks six on the floor; 15 on the optional cart
- 300 lb weight capacity warranty
- Complements Rio light task chair and stool; see [page 276](#)

1. Frame

Frame Type	Code	Price	
Wire Rod Chair	1051 FT2	\$280	
4-Leg Chair	1051 FT1	\$290	
24" Counter Stool	1051 FT1 S9	\$440	
30" Bar Stool	1051 FT1 S2	\$440	



MULTIPURPOSE CHAIR, COUNTER STOOL AND BAR STOOL

1. Frame (Cont.)



Frame Finish	Code	Price	
Black	FC1	+ \$0	
Silver (4-Leg Frame Only FT1)	FC2	+ \$0	
Chrome (Wire Rod Frame Only FT2)	FC15	+ \$0	

Arms and glides, if selected, are black for black frames and fog for silver or chrome frames.

2. Back and Seat

Back and Seat Style	Code	Price	
Plastic	PS	+ \$0	
Upholstered Seat	US	+ \$58	
Upholstered Seat and Back	UP	+ \$116	

3. Arms

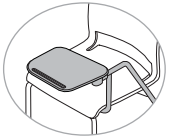
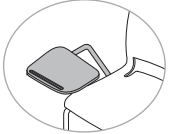
Arm Style	Code	Price	
Armless	A0	+ \$0	
Fixed Arms (4-Leg Frame Only FT1)	A91	+ \$58	
Fixed Arms (Wire Rod Frame Only FT2)	A131	+ \$58	
Tablet Arm			
Folding Tablet Arm, Left	RMTL	+ \$156	
Folding Tablet Arm, Right	RMTR	+ \$156	

Not available with wire rod (FT1) frames or stools (S9/S2). Not stackable. Tablet arm will be black for black (FC1) frame or fog for silver (FC2) frame.

4. Base

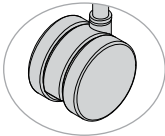
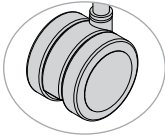
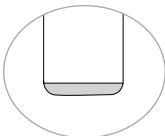
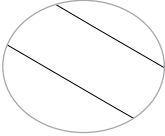
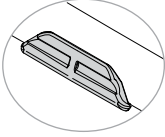
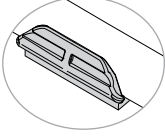
Casters or Glides	Code	Price	
Casters			
Carpet Casters	C13	+ \$40	
Hard Floor and Carpet Casters	C12	+ \$80	
Glides for 4-Leg Chair and Stool Only			
Standard Multi-Surface Glides	GL1	+ \$0	
Floor Saver Glides	GL3	+ \$17	
Steel Glides (Carpet Only)	GL4	+ \$17	
Performance Multi-Surface Glides	GL2	+ \$17	
Glides for Wire Rod Frame Only			
No Glides	G0	+ \$0	
Clear Glides	CGR	+ \$9	
Clear Glides With Felt	CGRF	+ \$22	

Please use caution when stacking models with casters to prevent frame damage. SitOnIt Seating does not warrant scratched frames.

MULTIPURPOSE CHAIR, COUNTER STOOL AND BAR STOOL

5. Miscellaneous

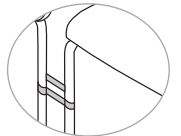
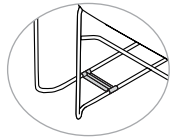
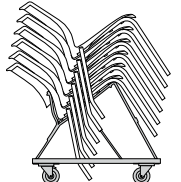
Accessories	Code	Price	
Ganging Bracket (For 4-Leg Chair FT1)	GG12	+ \$30	
Ganging Bracket (For Wire Rod Armless Models)	GG3	+ \$30	
Ganging Bracket (For Wire Rod Models With Arms)	GA4	+ \$30	
Stacking Cart	Cart	+ \$399	

Ganging brackets and stacking carts are not intended for use with caster models and are compatible with glides only. Accessories are not available for stools (S2/S9).

Due to the nature of upholstery, stacking may cause impressions on the seat. SitOnIt Seating does not warrant the effects of stacking on upholstery.

See page 594 for additional stacking requirements.

6. Material

Protection	Code	Price	
Fire Retardancy			
CAL 133, Fabric, Quantities 1-49	133F	+ \$64	
CAL 133, Fabric, Quantities 50+	133F5	+ \$20	
CAL 133, Plastic, Any Quantity	133P	+ \$10	
Shell Color			
Apple	SC24	+ \$0	
Arctic	SC21	+ \$0	
Bisque	SC7	+ \$0	
Black	SC1	+ \$0	
Chocolate	SC4	+ \$0	
Lagoon	SC15	+ \$0	
Latte	SC20	+ \$0	
Lemon	SC25	+ \$0	
Navy	SC5	+ \$0	
Pacific	SC22	+ \$0	
Red	SC19	+ \$0	
Slate	SC8	+ \$0	
Sterling	SC18	+ \$0	
Tangerine	SC23	+ \$0	

6. Material (Cont.)

Textile	Code	Price
Seat Only (US)		
Fabric/Vinyl Grade 1	FG1/VG1	+ \$0
COM	COM	+ \$22
Fabric/Vinyl Grade 2	FG2/VG2	+ \$22
Fabric/Vinyl Grade 3	FG3/VG3	+ \$45
Fabric/Vinyl Grade 4	FG4/VG4	+ \$77
Fabric/Vinyl Grade 5	FG5/VG5	+ \$116
Fabric/Vinyl Grade 6	FG6/VG6	+ \$159
Fabric/Vinyl Grade 7	FG7/VG7	+ \$200
Seat and Back (UP)		
Fabric/Vinyl Grade 1	FG1/VG1	+ \$0
COM	COM	+ \$34
Fabric/Vinyl Grade 2	FG2/VG2	+ \$34
Fabric/Vinyl Grade 3	FG3/VG3	+ \$74
Fabric/Vinyl Grade 4	FG4/VG4	+ \$121
Fabric/Vinyl Grade 5	FG5/VG5	+ \$174
Fabric/Vinyl Grade 6	FG6/VG6	+ \$235
Fabric/Vinyl Grade 7	FG7/VG7	+ \$296

Please reference the [Textile Reference Guide](#) for pricing on fabric over grade 7. Additional CAL 133 information can be found on [page 15](#).

Please reference the [Fabric](#) information found on [page 17](#) for pricing on multi-upholstery.

7. Packaging

Packaging	Code	Price
Fully Assembled In a Carton	AC	+ \$0
Fully Assembled In a Carton, Individually Packaged	AC1	+ \$20

MULTIPURPOSE CHAIR, COUNTER AND BAR STOOL

CHAIR SPECIFICATIONS

Model:	1051 FT1 4-Leg Multipurpose Chair	1051 FT2 Wire Rod Multipurpose Chair
Dimensions		
Overall Width Armless	21.2"	21.2"
Overall Width With Arms	22.2"	22.2"
Overall Depth	21.6"	23.2"
Overall Height	33.4"	33.4"
Seat Width	18.5"	18.5"
Seat Depth	18.2"	18.2"
Seat Height	17.9"	17.9"
Back Width	18.2"	18.2"
Back Height	17.5"	17.5"
Materials		
COM	0.85 yd (US) 1 yd (UP)	0.85 yd (US) 1 yd (UP)
Weight and Capacity		
Weight Armless	12.3 lb	15 lb
Weight With Arms	13.8 lb	18 lb
Weight Capacity Warranty	300 lb	300 lb

Upholstered seat only (US). Upholstered seat and back (UP).

STOOL SPECIFICATIONS

Model:	1051 FT1 S9 24" 4-Leg Counter Stool	1051 FT1 S2 30" 4-Leg Bar Stool
Dimensions		
Overall Width Armless	21.2"	21.2"
Overall Width With Arms	22.2"	22.2"
Overall Depth	22.2"	22.2"
Overall Height	40.35"	45.6"
Seat Width	18.5"	18.5"
Seat Depth	18.2"	18.2"
Seat Height	24.85"	30.1"
Back Width	18.2"	18.2"
Back Height	17.5"	17.5"
Materials		
COM	0.85 yd (US) 1 (UP)	0.85 yd (US) 1 (UP)
Weight and Capacity		
Weight Armless	17 lb	20.3 lb
Weight With Arms	18.7 lb	21.9 lb
Weight Capacity Warranty	300 lb	300 lb

Upholstered seat only (US). Upholstered seat and back (UP).

Rowdy

MULTIPURPOSE CHAIR

Value to shout about.

Rowdy is a one-piece multipurpose chair that will fit any space and any budget. Put Rowdy anywhere from meeting, training and conference rooms to auditorium and theater settings. The built-in hand-hold in the back allows easy repositioning. Stack Rowdy up to 40 high on its optional stacking cart and whisk them away for easy storage when space is at a premium.



EFFECTIVE OCTOBER 17, 2022

Featured Models

GOOD :: \$194

All-plastic seat and back, armless, no glides

BETTER :: \$252

Upholstered seat, plastic back, armless, no glides, grade 1 fabric



BEST :: \$332

Upholstered seat, plastic back, clear glides with felt, grade 1 fabric

Features

- 14 plastic colors
- Built-in pull handle
- Wire-frame construction
- Black or chrome frame
- All plastic models stack 15 on the floor; 40 on the optional cart
- 250 lb weight capacity warranty

1. Seat

Seat Style	Code	Price	
Plastic	No Code	\$194	
Upholstered Seat	US	\$252	

Do not stack upholstered seats.

2. Frame

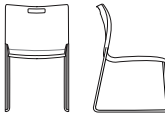
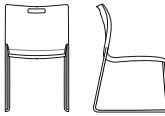
Frame Finish	Code	Price	
Black Wire Rod Base	92 SB	+ \$0	
Chrome Wire Rod Base	92 SC	+ \$0	

MULTIPURPOSE CHAIR

3. Arms

Arm Style	Code	Price	
Armless	A0	+ \$0	

4. Base

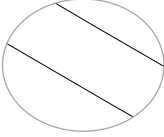
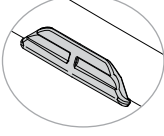
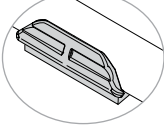
Glides	Code	Price	
No Glides	N	+ \$0	
Clear Glides	CGR	+ \$9	
Clear Glides With Felt	CGRF	+ \$22	

5. Miscellaneous

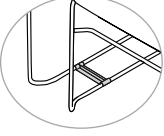
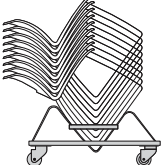
Accessories	Code	Price	
Ganging Bracket	GG5	+ \$12	
Stacking Cart	CART	+ \$399	

Due to the nature of upholstery, stacking may cause impressions on the seat. SitOnIt Seating does not warrant the effects of stacking on upholstery.

See [page 594](#) for additional stacking requirements.

6. Material

Protection	Code	Price
Fire Retardancy		
CAL 133 Fabric, Quantities 1-49	133F	+ \$99
CAL 133 Fabric, Quantities 50+	133F5	+ \$55
CAL 133 Plastic, Any Quantity	133P	+ \$45
Shell Color	Code	Price
Apple	SC24	+ \$0
Arctic	SC21	+ \$0
Bisque	SC7	+ \$0
Black	SC1	+ \$0
Chocolate	SC4	+ \$0
Lagoon	SC15	+ \$0
Latte	SC20	+ \$0
Lemon	SC25	+ \$0
Navy	SC5	+ \$0
Pacific	SC22	+ \$0
Red	SC19	+ \$0
Slate	SC8	+ \$0
Sterling	SC18	+ \$0
Tangerine	SC23	+ \$0
Seat Textile (For US)	Code	Price
Fabric/Vinyl Grade 1	FG1/VG1	+ \$0
COM	COM	+ \$22
Fabric/Vinyl Grade 2	FG2/VG2	+ \$22
Fabric/Vinyl Grade 3	FG3/VG3	+ \$45
Fabric/Vinyl Grade 4	FG4/VG4	+ \$77
Fabric/Vinyl Grade 5	FG5/VG5	+ \$116
Fabric/Vinyl Grade 6	FG6/VG6	+ \$159
Fabric/Vinyl Grade 7	FG7/VG7	+ \$200

Please reference the [Textile Reference Guide](#) for pricing on fabric over grade 7.
Stacking vinyl upholstered seat is not covered by warranty.

7. Packaging

Packaging	Code	Price
Fully Assembled in a Carton	AC4	+ \$0
Fully Assembled in a Carton, Individually Packaged	AC1	+ \$20

MULTIPURPOSE CHAIR

SPECIFICATIONS

Model:	92 Wire Rod Multipurpose Chair
Dimensions	
Overall Width	19.5"
Overall Depth	22"
Overall Height	33"
Seat Width	17"
Seat Depth	17"
Seat Height	17.5"
Back Width	19"
Back Height	16"
Materials	
COM	0.75 yd (US)
Stacking	
Max Cart Stacking Armless	40 (Plastic), N/A (Upholstered)
Max Floor Stacking Armless	15 (Plastic), N/A (Upholstered)
Weight and Capacity	
Weight Armless	13 lb
Weight Capacity Warranty	250 lb



Sprout

MULTIPURPOSE CHAIR

*It's friendly—
ergo and eco.*

The supportive, flexing back on Sprout™ provides extra ergonomics while the simple shell + frame construction makes it 100% recyclable (and super easy to maintain). It pairs a refined silhouette with rugged durability and stacks higher than any other chair we have. Whether spread out, stacked up or stored away, Sprout is always ready to thrive.

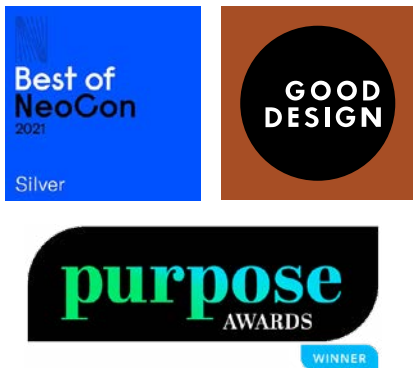

Better

Featured Models

GOOD :: \$228

Plastic seat and back, armless, wire rod base, no glides

BETTER :: \$237

Plastic seat and back, armless, wire rod base, clear glides

Features

- Space-saving design features high-density stacking (up to 40 on a cart and 10 on the floor)
- Ergonomic contouring with 10-degree flexing back provides superior comfort
- Durable and simple shell + frame construction means it's easy to maintain—and is 100% recyclable when it's time to replace
- Slim lines and silhouette complement an array of environments
- Large clean-out makes clean-up quick
- Ganging option locks chairs together effortlessly, creating well-ordered rows for seating
- Nine shell colors and two frame colors
- 300 lb weight capacity warranty

1. Frame

Frame Type	Code	Price	
------------	------	-------	--

Wire Rod Chair

1181 FT2

\$228



Frame Finish	Code	Price	
--------------	------	-------	--

Black

FC1

+ \$0

Chrome

FC15

+ \$0

2. Seat and Back

Seat	Code	Price	
------	------	-------	--

Plastic

PS

+ \$0



Back	Code	Price	
------	------	-------	--

Plastic

PB

+ \$0

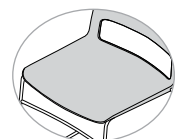

MULTIPURPOSE CHAIR

3. Arms

Arm Style	Code	Price	
-----------	------	-------	--

Armless

AR0

+\$0



4. Base

Glides	Code	Price	
--------	------	-------	--

No Glides

G0

+\$0

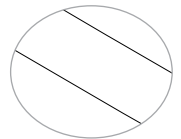

Clear Glides

CGR

+\$9

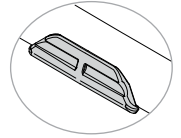

Clear Glides With Felt

CGRF

+\$22

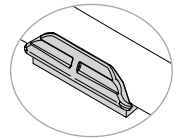

5. Miscellaneous

Accessories	Code	Price	
-------------	------	-------	--

Ganging Bracket

GG

+\$12

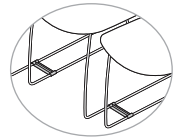

Stacking Cart

CART

+\$399

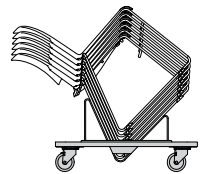

See [page 594](#) for additional stacking requirements.

MULTIPURPOSE CHAIR

6. Material

Shell Color	Code	Price
Arctic	SC21	+\$0
Black	SC1	+\$0
Chocolate	SC4	+\$0
Lagoon	SC15	+\$0
Latte	SC20	+\$0
Navy	SC5	+\$0
Red	SC19	+\$0
Slate	SC8	+\$0
Sterling	SC18	+\$0

7. Packaging

Packaging	Code	Price
Fully Assembled In a Carton	AC	+\$0
Fully Assembled in a Carton, Individually Packaged	AC1	+\$20

SPECIFICATIONS

	Wire Rod 1181 FT2
Dimensions	
Overall Width	21.25"
Overall Depth	22"
Overall Height	32"
Seat Width	18.75"
Seat Depth	16"
Seat Height	18.5"
Back Width	18.5"
Back Height	16"
Stacking	
Maximum Floor Stacking	10
Maximum Cart Stacking	40
Dimensions	
Weight	14.5 lb
Weight Capacity Warranty	300 lb



Stacking Cart

Wit Side

MESH BACK MULTIPURPOSE CHAIR

Work smarter.

A slimmer, stationary version of the task chair, our Wit Side is ideal for high-traffic settings like break rooms and cafeterias. Thanks to its ultra-lightweight frame and identical built-in pull handle, you can swing it around and rearrange spaces easily to accommodate the constant flow of crowded areas.



EFFECTIVE OCTOBER 17, 2022

Featured Models

GOOD :: \$373

Mesh back, plastic seat, armless, standard multi-surface glides

BETTER :: \$489

Mesh back, upholstered seat, fixed arms, standard multi-surface glides, grade 1 textile

BEST :: \$529

Mesh back, upholstered seat, fixed arms, carpet casters, grade 1 textile

Features

- Complements Wit task chair and Wit task stool
- Upholstered seat or plastic seat in three colors
- 12 mesh back colors
- Built-in pull handle
- Black or silver frame
- Wall-saver frame design
- Textured arm pads
- Stacks four on the floor, four on the optional cart
- Choose from two caster types and four glide options
- 300 lb weight capacity warranty
- Complements by Wit task chair and stool; see [page 184](#) and [page 188](#)

1. Frame

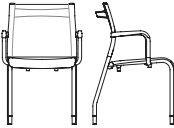
Frame Type	Code	Price	
4-Leg Side	2221 FT1 MB	\$489	
Frame Finish	Code	Price	
Black	FC1	+ \$0	
Silver	FC2	+ \$0	

2. Seat

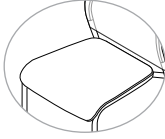
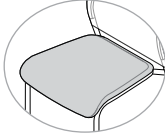
Seat Style	Code	Price	
Plastic Seat	PS	- \$58	
Upholstered Seat	US	+ \$0	

MESH BACK MULTIPURPOSE CHAIR

3. Arms

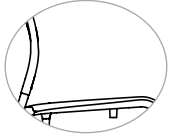
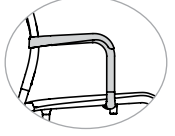

Arm Style	Code	Price	
Armless	AR0	- \$58	
Fixed Loop	AR1	+ \$0	

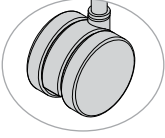
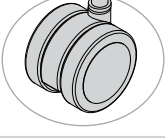
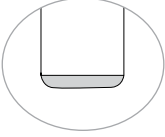
4. Base

Casters or Glides	Code	Price	
Casters			
Black Carpet Casters	CS5	+ \$40	
Hard Floor and Carpet Casters	CS6	+ \$80	
Glides			
Standard Multi-Surface Glides	GL1	+ \$0	
Floor Saver Glides	GL3	+ \$17	
Steel Glides (Carpet Only)	GL4	+ \$17	
Performance Multi-Surface Glides	GL2	+ \$17	

Please use caution when stacking models with casters to prevent frame damage. SitOnIt Seating does not warrant scratched frames.

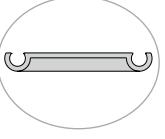
5. Miscellaneous

Accessories	Code	Price	
Ganging Brackets for Armless Models	GG	+ \$30	
Ganging Brackets for Models With Arms	GA	+ \$30	
Stacking Cart	CART	+ \$399	

Stacking cart (CART) is not compatible with caster models (CS5/CS6). See [page 594](#) for additional stacking requirements.

Due to the nature of upholstery, stacking may cause impressions on the seat. SitOnIt Seating does not warrant the effects of stacking on upholstery.

6. Material

Protection	Code	Price
Fire Retardancy		
CAL 133, Fabric, Quantities 1-49	133F	+ \$64
CAL 133, Fabric, Quantities 50+	133F5	+ \$20
CAL 133, Leather, Any Quantity	133L	+ \$119
CAL 133, Plastic, Any Quantity	133P	+ \$10
Mesh Color	Code	Price
Apple	MC31	+ \$0
Aqua	MC30	+ \$0
Desert	MC22	+ \$0
Electric Blue	MC24	+ \$0
Fire	MC25	+ \$0
Fog	MC23	+ \$0
Grape	MC26	+ \$0
Lemon	MC27	+ \$0
Nickel	MC21	+ \$0
Ocean	MC29	+ \$0
Onyx	MC20	+ \$0
Tangerine	MC28	+ \$0
Shell Color (For PS)	Code	Price
Black	SC1	+ \$0
Navy	SC5	+ \$0
Slate	SC8	+ \$0
Seat Textile Only (For US)	Code	Price
Fabric/Vinyl Grade 1	FG1/VG1	+ \$0
COM	COM	+ \$22
Fabric/Vinyl Grade 2	FG2/VG2	+ \$22
Fabric/Vinyl Grade 3	FG3/VG3	+ \$45
Fabric/Vinyl Grade 4	FG4/VG4	+ \$77
Fabric/Vinyl Grade 5	FG5/VG5	+ \$116
Fabric/Vinyl Grade 6	FG6/VG6	+ \$159
Fabric/Vinyl Grade 7	FG7/VG7	+ \$200
Leather Grade 1	LG1	+ \$140
COL	COL	+ \$200
Leather Grade 2	LG2	+ \$200
Leather Grade 3	LG3	+ \$280

Please reference the [Textile Reference Guide](#) for pricing on fabric over grade 7 or leather over grade 3.

MESH BACK MULTIPURPOSE CHAIR

7. Packaging

Packaging	Code	Price
Fully Assembled In a Carton	AC3	+ \$0
Individually Packaged	AC1	+ \$20

SPECIFICATIONS

Model:	2221 FT1 MB Mesh Side Chair	2221 FT1 MB Mesh Side Chair With Casters
Dimensions		
Overall Width Armless	19.25"	21.75"
Overall Width With Arms	22.5"	22.5"
Overall Depth	23"	24.5"
Overall Height	33.75"	33.75"
Seat Width	18.5"	18.5"
Seat Depth	16.25"	16.25"
Seat Height	18.07" (PS) 18.53" (US)	18.07" (PS) 18.53" (US)
Back Width	19.25"	19.25"
Back Height	17"	17"
Materials		
COM	0.75 yd	0.75 yd
COL	10 sq ft	10 sq ft
Stacking		
Max Cart Stacking	4	Not Recommended
Max Floor Stacking	4	4
Weight and Capacity		
Cart Stacking Weight Armless	112 lb	Not Recommended
Cart Stacking Weight With Arms	128 lb	Not Recommended
Floor Stacking Weight Armless	62 lb	62 lb
Floor Stacking Weight With Arms	78 lb	78 lb
Weight Armless	14 lb (PS) 15.5 lb (US)	14 lb (PS) 15.5 lb (US)
Weight With Arms	18 lb (PS) 19.5 lb (US)	18 lb (PS) 19.5 lb (US)
Weight Capacity Warranty	300 lb	300 lb

Plastic seat (PS). Upholstered seat (US).

Wit Side

THINTEX BACK MULTIPURPOSE CHAIR

Work smarter.

A slimmer, stationary version of the task chair, our Wit Side is ideal for high-traffic settings like break rooms and cafeterias. Thanks to its ultra-lightweight frame and identical built-in pull handle, you can swing it around and rearrange spaces easily to accommodate the constant flow of crowded areas.



EFFECTIVE OCTOBER 17, 2022

Featured Models

GOOD :: \$414

Thintex back, plastic seat, armless, standard multi-surface glides

BETTER :: \$530

Thintex back, upholstered seat, fixed arms, standard multi-surface glides, grade 1 textile

BEST :: \$570

Thintex back, upholstered seat, fixed arms, carpet casters, grade 1 textile

Features

- Complements Wit task chair and Wit task stool
- Upholstered seat or plastic seat in three colors
- 12 Thintex back colors
- Built-in pull handle
- Black or silver frame
- Wall-saver frame design
- Textured arm pads
- Stacks four on the floor, four on the optional cart
- Choose from two caster types and four glide options
- 300 lb weight capacity warranty
- Complements by Wit task chair and stool; see [page 192](#) and [page 196](#)

1. Frame

Frame Type	Code	Price	
4-Leg Side	2221 FT1 TXB	\$530	

Frame Finish	Code	Price	
Black	FC1	+ \$0	
Silver	FC2	+ \$0	

2. Back



Back Material	Code	Price	
Fabric	TX1	+ \$0	
Vinyl	TX2	+ \$0	

THINTEX BACK MULTIPURPOSE CHAIR

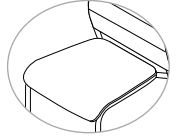
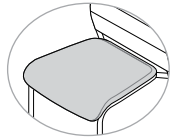
3. Seat

Seat Style	Code	Price	
Plastic Seat	PS	- \$58	
Upholstered Seat	US	+ \$0	

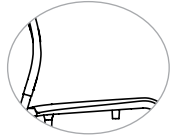
4. Arms

Arm Style	Code	Price	
Armless	AR0	- \$58	
Fixed Loop	AR1	+ \$0	

5. Base

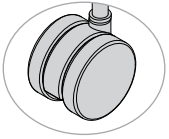
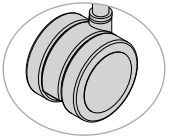
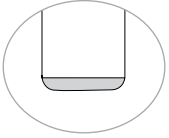
Casters or Glides	Code	Price	
Casters			
Black Carpet Casters	CS5	+ \$40	
Hard Floor and Carpet Casters	CS6	+ \$80	
Glides			
Standard Multi-Surface Glides	GL1	+ \$0	
Floor Saver Glides	GL3	+ \$17	
Steel Glides (Carpet Only)	GL4	+ \$17	
Performance Multi-Surface Glides	GL2	+ \$17	

Please use caution when stacking models with casters to prevent frame damage. SitOnIt Seating does not warrant scratched frames.

6. Miscellaneous

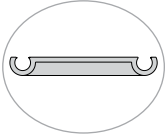
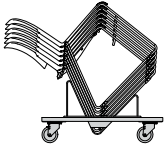
Accessories	Code	Price	
Ganging Brackets for Armless Models	GG	+ \$30	
Ganging Brackets for Models With Arms	GA	+ \$30	
Stacking Cart	CART	+ \$399	

Stacking cart (CART) is not compatible with caster models (CS5/CS6). See [page 594](#) for additional stacking requirements.

Due to the nature of upholstery, stacking may cause impressions on the seat. SitOnIt Seating does not warrant the effects of stacking on upholstery.

7. Material

Protection	Code	Price	
Fire Retardancy			
CAL 133, Fabric, Quantities 1-49	133F	+ \$64	
CAL 133, Fabric, Quantities 50+	133F5	+ \$20	
CAL 133, Leather, Any Quantity	133L	+ \$119	
CAL 133, Plastic, Any Quantity	133P	+ \$10	
Thintex Color	Code	Price	
Apple	MC31	+ \$0	
Aqua	MC30	+ \$0	
Desert	MC22	+ \$0	
Electric Blue	MC24	+ \$0	
Fire	MC25	+ \$0	
Fog	MC23	+ \$0	
Grape	MC26	+ \$0	
Lemon	MC27	+ \$0	
Nickel	MC21	+ \$0	
Ocean	MC29	+ \$0	
Onyx	MC20	+ \$0	
Tangerine	MC28	+ \$0	
Shell Color (For PS)	Code	Price	
Black	SC1	+ \$0	
Navy	SC5	+ \$0	
Slate	SC8	+ \$0	

THINTEX BACK MULTIPURPOSE CHAIR

7. Material (Cont.)

Seat Textile (For US)	Code	Price	
Fabric/Vinyl Grade 1	FG1/VG1	+ \$0	
COM	COM	+ \$22	
Fabric/Vinyl Grade 2	FG2/VG2	+ \$22	
Fabric/Vinyl Grade 3	FG3/VG3	+ \$45	
Fabric/Vinyl Grade 4	FG4/VG4	+ \$77	
Fabric/Vinyl Grade 5	FG5/VG5	+ \$116	
Fabric/Vinyl Grade 6	FG6/VG6	+ \$159	
Fabric/Vinyl Grade 7	FG7/VG7	+ \$200	
Leather Grade 1	LG1	+ \$140	
COL	COL	+ \$200	
Leather Grade 2	LG2	+ \$200	
Leather Grade 3	LG3	+ \$280	

Please reference the [Textile Reference Guide](#) for pricing on fabric over grade 7 or leather over grade 3.



EFFECTIVE OCTOBER 17, 2022 | GSA SIN #: 33721

8. Packaging

Packaging	Code	Price
Fully Assembled In a Carton	AC3	+ \$0
Fully Assembled In a Carton, Individually Packaged	AC1	+ \$20

SPECIFICATIONS

Model:	2221 FT1 TXB Thintex Side Chair	2221 FT1 TXB Thintex Side Chair With Casters
Dimensions		
Overall Width Armless	19.25"	21.75"
Overall Width With Arms	22.5"	22.5"
Overall Depth	23"	24.5"
Overall Height	33.75"	33.75"
Seat Width	18.5"	18.5"
Seat Depth	16.25"	16.25"
Seat Height	18.07" (PS) 18.53" (US)	18.07" (PS) 18.53" (US)
Back Width	19.25"	19.25"
Back Height	17"	17"
Materials		
COM	0.75 yd	0.75 yd
COL	10 sq ft	10 sq ft
Stacking		
Maximum Cart Stacking	4	Not Recommended
Maximum Floor Stacking	4	4
Weight and Capacity		
Cart Stacking Weight Armless	112 lb	Not Recommended
Cart Stacking Weight With Arms	128 lb	Not Recommended
Floor Stacking Weight Armless	62 lb	62 lb
Floor Stacking Weight With Arms	78 lb	78 lb
Weight Armless	14 lb (PS) 15.5 lb (US)	14 lb (PS) 15.5 lb (US)
Weight With Arms	18 lb (PS) 19.5 lb (US)	18 lb (PS) 19.5 lb (US)
Weight Capacity Warranty	300 lb	300 lb

Plastic seat (PS). Upholstered seat (US).



Lounge

CLUB CHAIR | SETTEE | SOFA
MODULAR LOUNGE
TANDEM SEATING | MULTISEATING
LINKING TABLES | COFFEE TABLES

Statement of Line

CLUB CHAIR | SETTEE | SOFA | MODULAR LOUNGE | MULTISEATING
TANDEM SEATING | BARIATRIC | LINKING TABLE | COFFEE TABLE

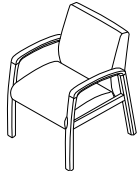

Aviera
Guest and Bariatric Seating
VRG Page 299

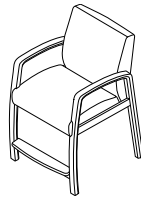

Aviera
Hip Chair
VRG FS3 Page 304

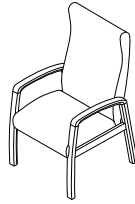

Aviera
Patient Seating
VRP Page 308

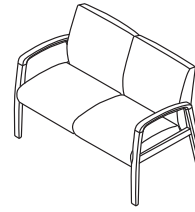

Aviera
Freespan 2-Seat
VRF SN2 Page 313

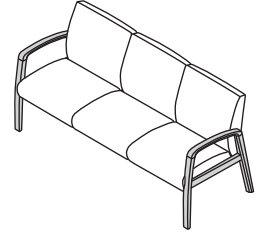

Aviera
Freespan 3-Seat
VRF SN3 Page 313

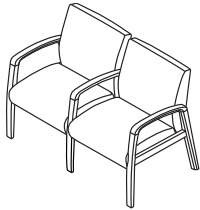

Aviera
Pre-Configured 2-Seat
VRC SN2 Page 318

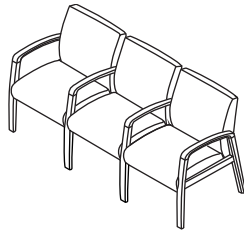

Aviera
Pre-Configured 3-Seat
VRC SN3 Page 318

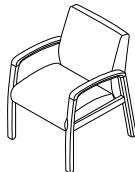

Aviera
Start Tandem Seating
VRM FS4 Page 323

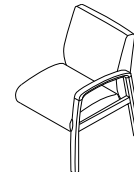

Aviera
Center/End Tandem Seating
VRM FS5/FS6 Page 323

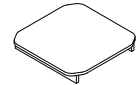

Aviera
Center Linking Table
VRL TTL1 Page 328



Aviera
End Linking Table
VRL TTL3 Page 328



Aviera
Round Corner Linking Table
VRL TTL4 Page 328

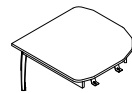

Aviera
Square Corner Linking Table
VRL TTL5 Page 328

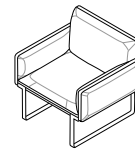

Cameo
Single Seat With Dual Arms
CAM SN1 FS8 Page 332

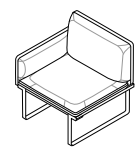

Cameo
Single Seat With Right Arm
CAM SN1 FS10 Page 332

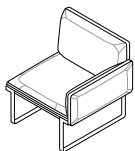

Cameo
Single Seat With Left Arm
CAM SN1 FS12 Page 332

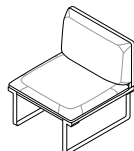

Cameo
Single Seat Armless
CAM SN1 FS17 Page 332

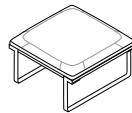

Cameo
Single Seat Bench
CAM SN1 FS2 Page 332

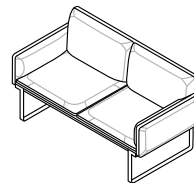

Cameo
2-Seater With Dual Arms
CAM SN2 FS8 Page 332

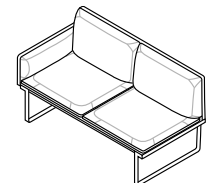

Cameo
2-Seater With Right Arm
CAM SN2 FS10 Page 332

Statement of Line

CLUB CHAIR | SETTEE | SOFA | MODULAR LOUNGE
TANDEM SEATING | MULTISEATING | LINKING TABLE | COFFEE TABLE

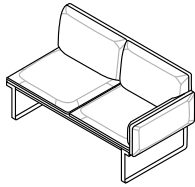

Cameo
2-Seater With Left Arm
CAM SN2 FS12..... Page 332

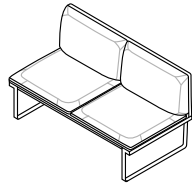

Cameo
2-Seater Armless
CAM SN2 FS17..... Page 332

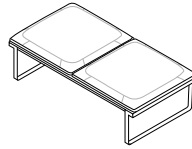

Cameo
2-Seater Bench
CAM SN2 FS2..... Page 332

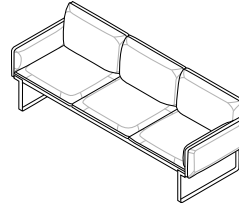

Cameo
3-Seater With Dual Arms
CAM SN3 FS8..... Page 332

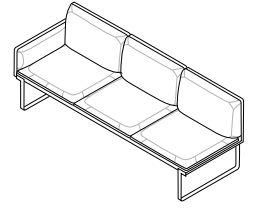

Cameo
3-Seater With Right Arm
CAM SN3 FS10..... Page 332

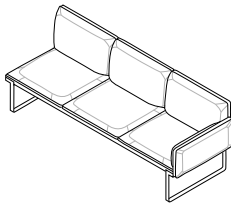

Cameo
3-Seater With Left Arm
CAM SN3 FS12..... Page 332

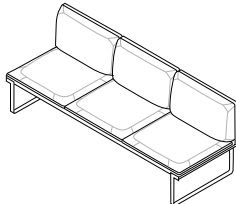

Cameo
3-Seater Armless
CAM SN3 FS17..... Page 332

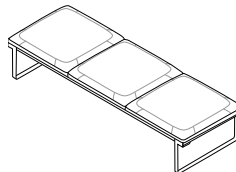

Cameo
3-Seater Bench
CAM SN3 FS2..... Page 332

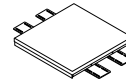

Cameo
Inline Table
CAMT TTL1..... Page 337

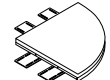

Cameo
Corner Table
CAMT TTL4..... Page 337

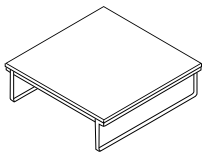

Cameo
Square Coffee Table
CAMT TT8..... Page 337

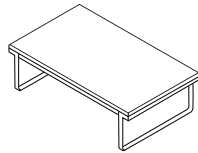

Cameo
Rectangular Coffee Table
CAMT TT9..... Page 337

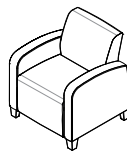

Composium
Curve Club Chair
CP AS3 SN1..... Page 339

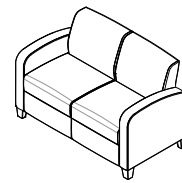

Composium
Curve Settee
CP AS3 SN2..... Page 339

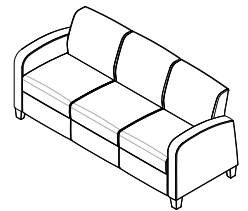

Composium
Curve Sofa
CP AS3 SN3..... Page 339

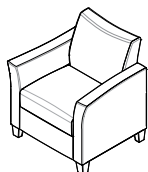

Composium
Flair Club Chair
CP AS2 SN1..... Page 344

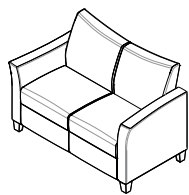

Composium
Flair Settee
CP AS2 SN2..... Page 344

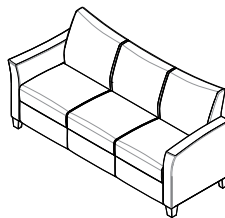

Composium
Flair Sofa
CP AS2 SN3..... Page 344

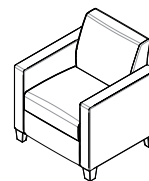

Composium
Sharp Club Chair
CP AS1 SN1..... Page 349

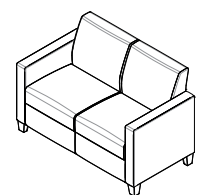

Composium
Sharp Settee
CP AS1 SN2..... Page 349

Statement of Line

CLUB CHAIR | SETTEE | SOFA | MODULAR LOUNGE | MULTISEATING
TANDEM SEATING | BARIATRIC | LINKING TABLE | COFFEE TABLE

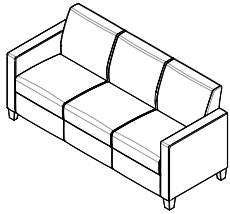

Composium

Sharp Sofa
CP AS1 SN3 Page 349

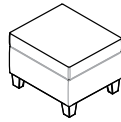

Composium

Ottoman
CP FS1..... Page 354

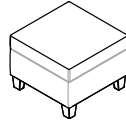

Composium

Single-Seat Bench
CP FS2 SN1..... Page 354

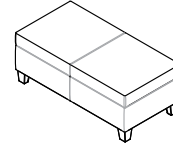

Composium

Double-Seat Bench
CP FS2 SN2..... Page 354

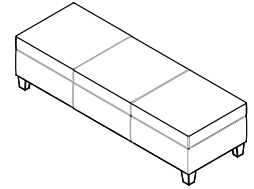

Composium

Three-Seat Bench
CP FS2 SN3..... Page 354



Envoi

Midback Lounge Chair
ENV BH4 Page 359



Envoi

Highback Lounge Chair
ENV BH5..... Page 359



Gobi

Midback Lounge Chair
GBI BH4..... Page 363



Nano

Triangle
NNO FS13..... Page 372



Nano

Triangle Table
NNO FS13 TM3/TM4....Page 372



Nano

Diamond
NNO FS14..... Page 372

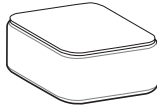

Nano Table

Diamond
NNO FS14 TM3/TM4....Page 372

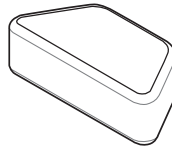

Nano

Trapezoid
NNO FS15..... Page 372

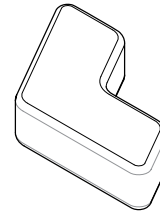

Nano

Boomerang
NNO FS16..... Page 372

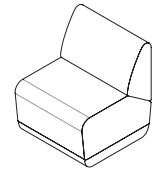

Paséa

Single Seat
PAS FS17 SS1 Page 381

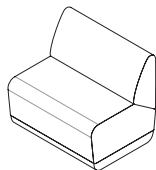

Paséa

1.5 Seat
PAS FS17 SS2 Page 381

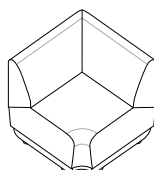

Paséa

90-Degree Corner Seat
PAS FS17 SS5 Page 381

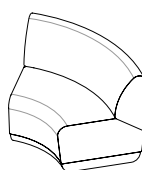

Paséa

120-Degree Inner Seat
PAS FS17 SS3 Page 381

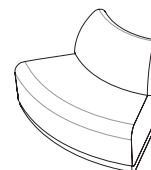

Paséa

120-Degree Outer Seat
PAS FS17 SS4 Page 381

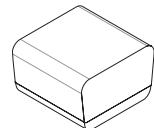

Paséa

90-Degree Corner Seat
PAS FS2 BNS1..... Page 381

Statement of Line

CLUB CHAIR | SETTEE | SOFA | MODULAR LOUNGE | MULTISEATING
TANDEM SEATING | BARIATRIC | LINKING TABLE | COFFEE TABLE

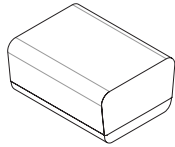

Paséa
90-Degree Corner Seat
PAS FS2 BNS2..... Page 381

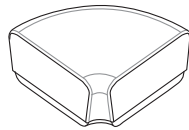

Paséa
90-Degree Corner Seat
PAS FS2 BNS6..... Page 381

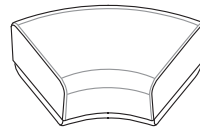

Paséa
120-Degree Bench
PAS FS17 SS5 Page 381

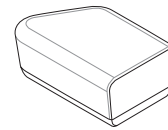

Paséa
Right-Angled End Bench
PAS FS2 BNS3..... Page 381

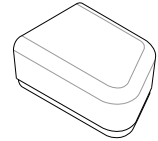

Paséa
Left-Angled End Bench
PAS FS2 BNS4..... Page 381



Paséa
Mini Round Ottoman
PAS FS1 OS1 Page 389



Paséa
Mini Square Ottoman
PAS FS1 OS3..... Page 389



Paséa
Large Round Ottoman
PAS FS1 OS2..... Page 389



Paséa
Large Square Ottoman
PAS FS1 OS4..... Page 389

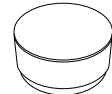

Paséa
Mini Round Table
PAS FS1 OS1 TM3.. Page 389



Paséa
Mini Square Table
PAS FS1 OS3 TM3.. Page 389

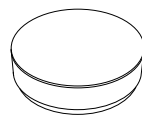

Paséa
Large Round Table
PAS FS1 OS2 TM3.. Page 389



Paséa
Large Square Table
PAS FS1 OS4 TM3.. Page 389

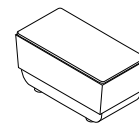

Paséa
13" x 27" Table
FS18 BNS7 Page 393

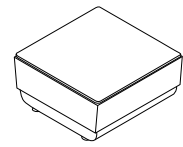

Paséa
27" x 27" Table
FS18 BNS1 Page 393

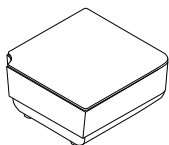

Paséa
90-Degree Corner Table
FS18 BNS5 Page 393

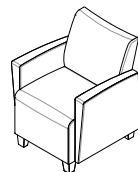

Visit Modular
Club Chair With
Upholstered Arms
VS FS8 Page 396

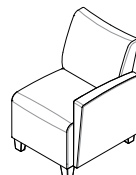

Visit Modular
Club Chair With
Upholstered Left Arm
VS FS12 Page 396

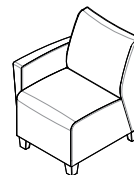

Visit Modular
Club Chair With
Upholstered Right Arm
VS FS10 Page 396

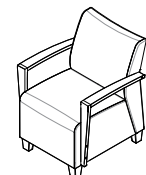

Visit Modular
Club Chair With
Two Wood Arms
VS FS7 Page 396

Statement of Line

CLUB CHAIR | SETTEE | SOFA | MODULAR LOUNGE | MULTISEATING
TANDEM SEATING | BARIATRIC | LINKING TABLE | COFFEE TABLE

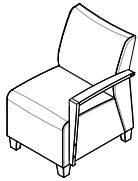

Visit Modular

Club Chair With Wood Left Arm
VS FS11 Page 396



Visit Modular

Club Chair With Wood Right Arm
VS FS9 Page 396

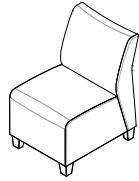

Visit Modular

Armless Club Chair
VS Page 396

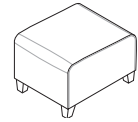

Visit Modular

Ottoman
VS FS1 Page 396

Aviera

GUEST AND BARIATRIC SEATING

Comfort that lasts.

Whether lobby, lounge, welcoming or waiting, you can rest easy with supremely comfortable do-it-all seating for your public spaces. Aviera makes it easy to configure endlessly and effortlessly—across an entire collection—with worry-free design and lasting durability, including metal or wood frames that feature an integrated steel structure. Discover an industry-leading seating solution and get peace of mind for any project.



Metal

EFFECTIVE OCTOBER 17, 2022

Featured Models

METAL :: \$1,434

Metal frame, 21" seat, open arms, polyurethane arm caps, multi-upholstery, grade 2 vinyl seat, grade 5 vinyl back

WOOD :: \$1,778

Maple frame, 21" seat, open arms, no arm caps, multi-upholstery, grade 4 vinyl seat, grade 7 vinyl back

BARIATRIC :: \$2,110

Metal frame, 30" seat, open arms, polyurethane arm caps, multi-upholstery, grade 4 vinyl seat, grade 7 fabric back

Features

- Easy ingress and egress with 18.5" seat height and waterfall seat design
- Clean-out space
- Steel-frame construction with metal-to-metal connections
- Beveled, wall-saving frame design
- Two frame materials: Durable aluminum frame or wood frame with silver ion anti-microbial finish
- Three metal frame finishes or four wood frame finishes
- Polyurethane, wood or solid surface arm caps
- Replaceable parts including seat, back, arms, arm caps and arm insets
- 21"/24" seats: 500 lb weight capacity warranty
30"/44" bariatric seats: 750 lb weight capacity warranty



Wood

1. Product

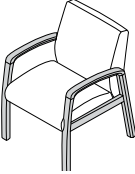

Model	Code	Price	
Guest	VRG	\$1,054	

2. Frame

Frame Material	Code	Price	
Metal	FM3	+ \$0	
Wood			
Beech	FM2	+ \$10	
Maple	FM1	+ \$68	
Frame Finish	Code	Price	
For Metal Frame			
Silver Metallic	FCM1	+ \$0	
Graphite	FCM2	+ \$0	
Taupe	FCM3	+ \$0	
For Wood Frame			
Clear Maple	FCW1	+ \$0	
Medium Cherry	FCW2	+ \$0	
Amber Mahogany	FCW3	+ \$0	
Espresso	FCW4	+ \$0	
Stain-to-Match	STM	+ \$70	
New Custom Stain	STL	+ \$275	
Frame Options	Code	Price	
Protective Guard Clear Tape	FX1	+ \$84	

New Custom Stain (STL): If stain is not in our library, add this one-time \$275 net fee in addition to the \$70 stain-to-match (STM) cost.

3. Seat

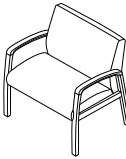
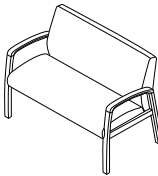
Seat Width	Code	Price	
21" (500 lb Weight Capacity)	SW21	+ \$0	
24" (500 lb Weight Capacity)	SW24	+ \$55	
Bariatric			
30" (750 lb Weight Capacity)	SW30	+ \$275	
44" (750 lb Weight Capacity)	SW44	+ \$500	

See the Super Duty Guide on page 591 for additional high weight capacity products.

4. Arms

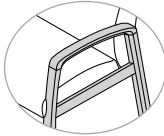
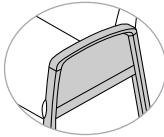
Arm Type	Code	Price	
Open Arm	AT1	+ \$0	
Upholstered Arm	AT2	+ \$86	

GUEST AND BARIATRIC SEATING

4. Arms (Cont.)

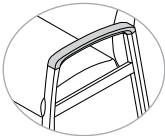
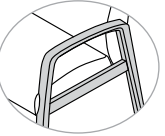
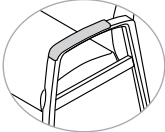
Arm Cap Material	Code	Price	
For Metal Frame			
Polyurethane	ACP4	+ \$0	
Wood	ACP3	+ \$80	
Solid Surface	ACP5	+ \$450	
For Wood Frame			
No Arm Caps	ACP0	+ \$0	
Polyurethane	ACP2	+ \$120	

Arm Cap Finish	Code	Price	
For Polyurethane Arm Caps			
Black	RMC3	+ \$0	
Fog	RMC4	+ \$0	
Dark Grey	RMC5	+ \$0	
For Wood Arm Caps			
Clear Maple	FCW1	+ \$0	
Medium Cherry	FCW2	+ \$0	
Amber Mahogany	FCW3	+ \$0	
Espresso	FCW4	+ \$0	
Stain-to-Match	STM	+ \$70	
New Custom Stain	STL	+ \$275	

For Solid Surface Arm Caps			
Designer White	TSS2	+ \$0	

New Custom Stain (STL): If stain is not in our library, add this one-time \$275 net fee in addition to the \$70 stain-to-match (STM) cost.

Upholstered arm textile will match seat textile.

5. Material

Protection	Code	Price	
Fire Retardancy			
CAL 133	UCAL	+ \$100	
Cleaning	Code	Price	
Moisture Barrier			
Seat Only	UM2	+ \$65	
Back Only	UM1	+ \$65	
Seat and Back	UM3	+ \$130	
Fully Upholstered	Code	Price	
Seat and Back Textile		21"/24"	30"/44"
Fabric/Vinyl Grade 1	FG1/VG1	+ \$0	+ \$0
COM	COM	+ \$60	+ \$100
Fabric/Vinyl Grade 2	FG2/VG2	+ \$60	+ \$100
Fabric/Vinyl Grade 3	FG3/VG3	+ \$150	+ \$220
Fabric/Vinyl Grade 4	FG4/VG4	+ \$275	+ \$365
Fabric/Vinyl Grade 5	FG5/VG5	+ \$415	+ \$525
Fabric/Vinyl Grade 6	FG6/VG6	+ \$575	+ \$705
Fabric/Vinyl Grade 7	FG7/VG7	+ \$735	+ \$885
Leather Grade 1	LG1	+ \$600	+ \$685
COL	COL	+ \$700	+ \$805
Leather Grade 2	LG2	+ \$700	+ \$805
Leather Grade 3	LG3	+ \$800	+ \$1,005
Multi-Upholstery	Code	Price	
		21"/24"	30"/44"
Multi-Upholstery Upcharge	UMU	+ \$113	+ \$113
Seat Textile Only		21"/24"	30"/44"
Fabric/Vinyl Grade 1	FG1/VG1	+ \$0	+ \$0
COM	COM	+ \$26	+ \$42
Fabric/Vinyl Grade 2	FG2/VG2	+ \$26	+ \$42
Fabric/Vinyl Grade 3	FG3/VG3	+ \$63	+ \$93
Fabric/Vinyl Grade 4	FG4/VG4	+ \$116	+ \$154
Fabric/Vinyl Grade 5	FG5/VG5	+ \$175	+ \$221
Fabric/Vinyl Grade 6	FG6/VG6	+ \$242	+ \$297
Fabric/Vinyl Grade 7	FG7/VG7	+ \$309	+ \$372
Leather Grade 1	LG1	+ \$252	+ \$288
COL	COL	+ \$294	+ \$339
Leather Grade 2	LG2	+ \$294	+ \$339
Leather Grade 3	LG3	+ \$336	+ \$423

5. Material (Cont.)

Multi-Upholstery	Code	Price	
Back Textile Only		21"/24"	30"/44"
Fabric/Vinyl Grade 1	FG1/VG1	+ \$0	+ \$0
COM	COM	+ \$35	+ \$58
Fabric/Vinyl Grade 2	FG2/VG2	+ \$35	+ \$58
Fabric/Vinyl Grade 3	FG3/VG3	+ \$87	+ \$128
Fabric/Vinyl Grade 4	FG4/VG4	+ \$160	+ \$212
Fabric/Vinyl Grade 5	FG5/VG5	+ \$241	+ \$305
Fabric/Vinyl Grade 6	FG6/VG6	+ \$334	+ \$409
Fabric/Vinyl Grade 7	FG7/VG7	+ \$427	+ \$514
Leather Grade 1	LG1	+ \$348	+ \$398
COL	COL	+ \$406	+ \$467
Leather Grade 2	LG2	+ \$406	+ \$467
Leather Grade 3	LG3	+ \$464	+ \$583

If different fabrics are selected for the seat and back, add the multi-upholstery upcharge as well, even if the fabrics are the same grade.

Please reference the Textile Reference Guide for pricing on fabric over grade 7 and leather over grade 3. Additional CAL 133 information can be found on page 15.

6. Options

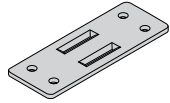
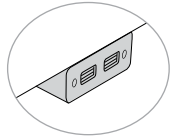
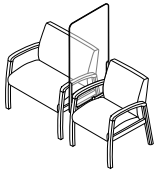
Ganging Brackets	Code	Price	
Ganging Brackets	XGV	+ \$103	
Power Options	Code	Price	
Power, Left	PFL	+ \$250	
Power, Right	PFR	+ \$250	
Screen	Code	Price	
Sector Seating Screen	3097 XRX	+ \$460	
Packaging	Code	Price	
Fully Assembled in a Carton	P1	+ \$0	

SPECIFICATIONS

Model:	21"	24"
Dimensions		
Height	34.5"	34.5"
Width	24.5"	27.5"
Depth	26.5"	26.5"
Arm Height (Height of Arms From Floor)	25.75"	25.75"
Arm Height (From Seat to Top of Arm)	7.25"	7.25"
Width Between Arms	20.75"	23.75"
Seat Width	21.75"	24.75"
Seat Depth	19"	19"
Seat Height	18.5"	18.5"
Back Height	18.5"	18.5"
Materials		
COM (Fully Upholstered)	1.9 yd	1.9 yd
COM (Multi-Upholstery)		
Seat Only	1.2 yd	1.2 yd
Back Only	1.1 yd	1.6 yd
COL (Fully Upholstered)	29.4 sq ft	43.4 sq ft
Weight and Capacity		
Weight	38 lb (FM3) 33 lb (FM1/FM2)	40 lb (FM3) 35 lb (FM1/FM2)
Weight Capacity Warranty	500 lb	500 lb

Metal frame (FM3), Beech wood frame (FM2), Maple wood frame (FM1).

Yardage requirements for COM and COL are for solid and non-directional fabrics. Additional material may be required for larger repeating patterns.

SPECIFICATIONS: BARIATRIC SIZES

Model:	30"	44"
Dimensions		
Height	34.5"	34.5"
Width	33.5"	47.5"
Depth	26.5"	26.5"
Arm Height (Height of Arms From Floor)	25.75"	25.75"
Arm Height (From Seat to Top of Arm)	7.25"	7.25"
Width Between Arms	29.75"	43.75"
Seat Width	30.75"	44.75"
Seat Depth	19"	19"
Seat Height	18.5"	18.5"
Back Height	18.5"	18.5"
Materials		
COM (Fully Upholstered)	3.1 yd	3.4 yd
COM (Multi-Upholstery)		
Seat Only	1.2 yd	1.6 yd
Back Only	1.9 yd	1.9 yd
COL (Fully Upholstered)	47.6 sq ft	50.4 sq ft
Weight and Capacity		
Weight	50 lb (FM3) 45 lb (FM1/FM2)	77 lb (FM3) 72 lb (FM1/FM2)
Weight Capacity Warranty	750 lb	750 lb

Metal frame (FM3), Beech wood frame (FM2), Maple wood frame (FM1).

Yardage requirements for COM and COL are for solid and non-directional fabrics. Additional material may be required for larger repeating patterns.



Bariatric

Aviera

HIP CHAIR

Comfort that lasts.

Whether lobby, lounge, welcoming or waiting, you can rest easy with supremely comfortable do-it-all seating for your public spaces. Aviera makes it easy to configure endlessly and effortlessly—across an entire collection—with worry-free design and lasting durability, including metal or wood frames that feature an integrated steel structure. Discover an industry-leading seating solution and get peace of mind for any project.



Metal

EFFECTIVE OCTOBER 17, 2022

Featured Models

METAL :: \$2,271

Metal frame, open arms, polyurethane arm caps, fully upholstered, grade 7 vinyl seat and back

WOOD :: \$2,186

Maple frame, open arms, no arm caps, multi-upholstery, grade 4 vinyl seat, grade 5 vinyl back

Features

- Easy ingress and egress with waterfall seat design
- Clean-out space
- Steel-frame construction with metal-to-metal connections
- Beveled, wall-saving frame design
- Elevated footrest with a non-slip textured surface
- Two frame materials: Durable aluminum frame or wood frame with silver ion anti-microbial finish
- Three metal frame finishes or four wood frame finishes
- Polyurethane, wood or solid surface arm caps
- Replaceable parts including seat, back, arms, arm caps and arm insets
- 500 lb weight capacity warranty



Wood

HIP CHAIR

1. Product

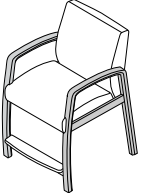
Model	Code	Price	
Hip Chair (500 lb Weight Capacity)	VRG FS3	\$1,536	

2. Frame

Frame Material	Code	Price	
Metal	FM3	+ \$0	
Wood			
Beech	FM2	+ \$93	
Maple	FM1	+ \$180	
Frame Finish	Code	Price	
For Metal Frame			
Silver Metallic	FCM1	+ \$0	
Graphite	FCM2	+ \$0	
Taupe	FCM3	+ \$0	
For Wood Frame			
Clear Maple	FCW1	+ \$0	
Medium Cherry	FCW2	+ \$0	
Amber Mahogany	FCW3	+ \$0	
Espresso	FCW4	+ \$0	
Stain-to-Match	STM	+ \$70	
New Custom Stain	STL	+ \$275	
Frame Options	Code	Price	
Protective Guard Clear Tape	FX1	+ \$84	

New Custom Stain (STL): If stain is not in our library, add this one-time \$275 net fee in addition to the \$70 stain-to-match (STM) cost.

3. Arms

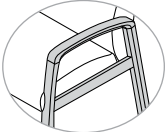
Arm Type	Code	Price	
Open Arm	AT1	+ \$0	

Upholstered Arm	AT2	+ \$86	
-----------------	-----	--------	---

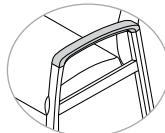
Arm Cap Material	Code	Price	
For Metal Frame			
Polyurethane	ACP4	+ \$0	
Wood	ACP3	+ \$80	
Solid Surface	ACP5	+ \$450	

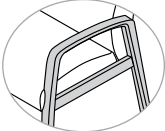
For Wood Frame			
No Arm Cap	ACP0	+ \$0	

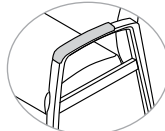
Polyurethane	ACP2	+ \$120	
--------------	------	---------	---

Arm Cap Finish	Code	Price	
For Polyurethane Arm Caps			
Black	RMC3	+ \$0	
Fog	RMC4	+ \$0	
Dark Grey	RMC5	+ \$0	

For Wood Arm Caps			
Clear Maple	FCW1	+ \$0	
Medium Cherry	FCW2	+ \$0	
Amber Mahogany	FCW3	+ \$0	
Espresso	FCW4	+ \$0	
Stain-to-Match	STM	+ \$70	
New Custom Stain	STL	+ \$275	

For Solid Surface Arm Caps			
Designer White	TSS2	+ \$0	

New Custom Stain (STL): If stain is not in our library, add this one-time \$275 net fee in addition to the \$70 stain-to-match (STM) cost.

Upholstered arm textile will match seat textile.

HIP CHAIR

4. Material

Protection	Code	Price	
Fire Retardancy			
CAL 133	UCAL	+ \$100	

Cleaning	Code	Price	
Moisture Barrier			

Seat Only	UM2	+ \$65	
Back Only	UM1	+ \$65	
Seat and Back	UM3	+ \$130	

Fully Upholstered	Code	Price	
Fabric/Vinyl Grade 1	FG1/VG1	+ \$0	
COM	COM	+ \$60	
Fabric/Vinyl Grade 2	FG2/VG2	+ \$60	
Fabric/Vinyl Grade 3	FG3/VG3	+ \$150	
Fabric/Vinyl Grade 4	FG4/VG4	+ \$275	
Fabric/Vinyl Grade 5	FG5/VG5	+ \$415	
Fabric/Vinyl Grade 6	FG6/VG6	+ \$575	
Fabric/Vinyl Grade 7	FG7/VG7	+ \$735	
Leather Grade 1	LG1	+ \$600	
COL	COL	+ \$700	
Leather Grade 2	LG2	+ \$700	
Leather Grade 3	LG3	+ \$800	

Multi-Upholstery	Code	Price	
Multi-Upholstery Upcharge	UMU	+ \$113	

Seat Textile Only			
Fabric/Vinyl Grade 1	FG1/VG1	+ \$0	
COM	COM	+ \$26	
Fabric/Vinyl Grade 2	FG2/VG2	+ \$26	
Fabric/Vinyl Grade 3	FG3/VG3	+ \$63	
Fabric/Vinyl Grade 4	FG4/VG4	+ \$116	
Fabric/Vinyl Grade 5	FG5/VG5	+ \$175	
Fabric/Vinyl Grade 6	FG6/VG6	+ \$242	
Fabric/Vinyl Grade 7	FG7/VG7	+ \$309	
Leather Grade 1	LG1	+ \$252	
COL	COL	+ \$294	
Leather Grade 2	LG2	+ \$294	
Leather Grade 3	LG3	+ \$336	

4. Material (Cont.)

Multi-Upholstery	Code	Price
Back Textile Only		
Fabric/Vinyl Grade 1	FG1/VG1	+ \$0
COM	COM	+ \$35
Fabric/Vinyl Grade 2	FG2/VG2	+ \$35
Fabric/Vinyl Grade 3	FG3/VG3	+ \$87
Fabric/Vinyl Grade 4	FG4/VG4	+ \$160
Fabric/Vinyl Grade 5	FG5/VG5	+ \$241
Fabric/Vinyl Grade 6	FG6/VG6	+ \$334
Fabric/Vinyl Grade 7	FG7/VG7	+ \$427
Leather Grade 1	LG1	+ \$348
COL	COL	+ \$406
Leather Grade 2	LG2	+ \$406
Leather Grade 3	LG3	+ \$464

If different fabrics are selected for the seat and back, add the multi-upholstery upcharge as well, even if the fabrics are the same grade.

Please reference the *Textile Reference Guide* for pricing on fabric over grade 7 and leather over grade 3. Additional CAL 133 information can be found on page 15.

5. Packaging

Packaging	Code	Price
Fully Assembled in a Carton	P1	+ \$0

HIP CHAIR

SPECIFICATIONS

Model:	VRG FS3 21" Hip Chair
Dimensions	
Height	40.25"
Width	24.5"
Depth	28.25"
Arm Height (Height of Arms From Floor)	31.75"
Arm Height (From Seat to Top of Arm)	7.25"
Width Between Arms	20.75"
Seat Width	21.75"
Seat Depth	19"
Seat Height	24.5"
Back Height	18.5"
Footrest Height (From Floor)	7"
Materials	
COM (Fully Upholstered)	1.9 yd
COM (Multi-Upholstery)	
Seat Only	1.2 yd
Back Only	1.1 yd
COL (Fully Upholstered)	29.4 sq ft
Weight and Capacity	
Weight	38 lb (FM3) 33 lb (FM1/FM2)
Weight Capacity Warranty	500 lb

Metal frame (FM3), Beech wood frame (FM2), Maple wood frame (FM1).

Yardage requirements for COM and COL are for solid and non-directional fabrics. Additional material may be required for larger repeating patterns.

Aviera

PATIENT SEATING

Comfort that lasts.

Whether lobby, lounge, welcoming or waiting, you can rest easy with supremely comfortable do-it-all seating for your public spaces. Aviera makes it easy to configure endlessly and effortlessly—across an entire collection—with worry-free design and lasting durability, including metal or wood frames that feature an integrated steel structure. Discover an industry-leading seating solution and get peace-of-mind for any project.



Metal

EFFECTIVE OCTOBER 17, 2022

Featured Models

METAL :: \$1,729

Metal frame, 21" seat, open arms, polyurethane arm caps, multi-upholstery, grade 4 vinyl seat and grade 5 vinyl back

WOOD :: \$1,983

Maple frame, 21" seat, open arms, no arm caps, multi-upholstery, grade 4 vinyl seat and grade 7 vinyl back

BARIATRIC :: \$2,203

Metal frame, 30" seat, open arms, polyurethane arm caps, multi-upholstery, grade 2 vinyl seat and grade 7 fabric back

Features

- Easy ingress and egress with waterfall seat design
- Clean-out space
- Steel-frame construction with metal-to-metal connections
- Beveled, wall-saving frame design
- Two frame materials: Durable aluminum frame or wood frame with silver ion anti-microbial finish
- Three metal frame finishes or four wood frame finishes
- Polyurethane, wood or solid surface arm caps
- Replaceable parts including seat, back, arms, arm caps and arm insets
- 21"/24" seat: 500 lb weight capacity warranty
30" bariatric seat: 750 lb weight capacity warranty



PATIENT SEATING

1. Product

Model	Code	Price	
Aviera Patient	VRP	\$1,259	

2. Frame

Frame Material	Code	Price	
Metal	FM3	+ \$0	
Wood			
Beech	FM2	+ \$10	
Maple	FM1	+ \$68	
Frame Finish	Code	Price	
For Metal Frame			
Silver Metallic	FCM1	+ \$0	
Graphite	FCM2	+ \$0	
Taupe	FCM3	+ \$0	
For Wood Frame			
Clear Maple	FCW1	+ \$0	
Medium Cherry	FCW2	+ \$0	
Amber Mahogany	FCW3	+ \$0	
Espresso	FCW4	+ \$0	
Stain-to-Match	STM	+ \$70	
New Custom Stain	STL	+ \$275	
Frame Options	Code	Price	
Protective Guard Clear Tape	FX1	+ \$84	

New Custom Stain (STL): If stain is not in our library, add this one-time \$275 net fee in addition to the \$70 stain-to-match (STM) cost.

3. Seat

Seat Width	Code	Price	
21" (500 lb Weight Capacity)	SW21	+ \$0	
24" (500 lb Weight Capacity)	SW24	+ \$55	
Bariatric			
30" (750 lb Weight Capacity)	SW30	+ \$275	

See the Super Duty Guide on page 591 for additional high weight capacity products.

4. Arms

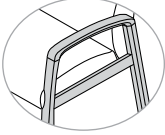
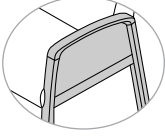
Arm Type	Code	Price	
Open Arm	AT1	+ \$0	
Upholstered Arm	AT2	+ \$86	

Upholstered arm textile will match seat textile.

PATIENT SEATING

4. Arms (Cont.)

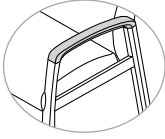
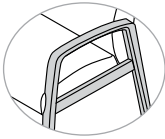
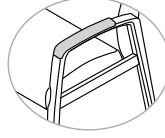
Arm Cap Material	Code	Price	
For Metal Frame			
Polyurethane	ACP4	+ \$0	
Wood	ACP3	+ \$80	
Solid Surface	ACP5	+ \$450	
Arm Cap Material	Code	Price	
For Wood Frame			
No Arm Cap	ACP0	+ \$0	
Polyurethane	ACP2	+ \$120	
Arm Cap Finish	Code	Price	
For Polyurethane Arm Caps			
Black	RMC3	+ \$0	
Fog	RMC4	+ \$0	
Dark Grey	RMC5	+ \$0	
For Wood Arm Caps			
Clear Maple	FCW1	+ \$0	
Medium Cherry	FCW2	+ \$0	
Amber Mahogany	FCW3	+ \$0	
Espresso	FCW4	+ \$0	
Stain-to-Match	STM	+ \$70	
New Custom Stain	STL	+ \$275	
For Solid Surface Arm Caps			
Designer White	TSS2	+ \$0	

New Custom Stain (STL): If stain is not in our library, add this one-time \$275 net fee in addition to the \$70 stain-to-match (STM) cost.

5. Material

Protection	Code	Price	
Fire Retardancy			
CAL 133	UCAL	+ \$100	
Cleaning	Code	Price	
Moisture Barrier			
Seat Only	UM2	+ \$65	
Back Only	UM1	+ \$65	
Seat and Back	UM3	+ \$130	
Fully Upholstered	Code	Price	
Seat and Back Textile		21"/24"	30"
Fabric/Vinyl Grade 1	FG1/VG1	+ \$0	+ \$0
COM	COM	+ \$60	+ \$100
Fabric/Vinyl Grade 2	FG2/VG2	+ \$60	+ \$100
Fabric/Vinyl Grade 3	FG3/VG3	+ \$150	+ \$220
Fabric/Vinyl Grade 4	FG4/VG4	+ \$275	+ \$365
Fabric/Vinyl Grade 5	FG5/VG5	+ \$415	+ \$525
Fabric/Vinyl Grade 6	FG6/VG6	+ \$575	+ \$705
Fabric/Vinyl Grade 7	FG7/VG7	+ \$735	+ \$885
Leather Grade 1	LG1	+ \$600	+ \$685
COL	COL	+ \$700	+ \$805
Leather Grade 2	LG2	+ \$700	+ \$805
Leather Grade 3	LG3	+ \$800	+ \$1,005
Multi-Upholstery	Code	Price	
		21"/24"	30"
Multi-Upholstery Upcharge	UMU	+ \$113	+ \$113
Seat Textile Only		21"/24"	30"
Fabric/Vinyl Grade 1	FG1/VG1	+ \$0	+ \$0
COM	COM	+ \$26	+ \$42
Fabric/Vinyl Grade 2	FG2/VG2	+ \$26	+ \$42
Fabric/Vinyl Grade 3	FG3/VG3	+ \$63	+ \$93
Fabric/Vinyl Grade 4	FG4/VG4	+ \$116	+ \$154
Fabric/Vinyl Grade 5	FG5/VG5	+ \$175	+ \$221
Fabric/Vinyl Grade 6	FG6/VG6	+ \$242	+ \$297
Fabric/Vinyl Grade 7	FG7/VG7	+ \$309	+ \$372
Leather Grade 1	LG1	+ \$252	+ \$288
COL	COL	+ \$294	+ \$339
Leather Grade 2	LG2	+ \$294	+ \$339
Leather Grade 3	LG3	+ \$336	+ \$423
Back Textile Only		21"/24"	30"
Fabric/Vinyl Grade 1	FG1/VG1	+ \$0	+ \$0
COM	COM	+ \$35	+ \$58

PATIENT SEATING

5. Material (Cont.)

Multi-Upholstery	Code	Price	
Fabric/Vinyl Grade 2	FG2/VG2	+ \$35	+ \$58
Fabric/Vinyl Grade 3	FG3/VG3	+ \$87	+ \$128
Fabric/Vinyl Grade 4	FG4/VG4	+ \$160	+ \$212
Fabric/Vinyl Grade 5	FG5/VG5	+ \$241	+ \$305
Fabric/Vinyl Grade 6	FG6/VG6	+ \$334	+ \$409
Fabric/Vinyl Grade 7	FG7/VG7	+ \$427	+ \$514
Leather Grade 1	LG1	+ \$348	+ \$398
COL	COL	+ \$406	+ \$467
Leather Grade 2	LG2	+ \$406	+ \$467
Leather Grade 3	LG3	+ \$464	+ \$583

If different fabrics are selected for the seat and back, add the multi-upholstery upcharge as well, even if the fabrics are the same grade.

Please reference the *Textile Reference Guide* for pricing on fabric over grade 7 and leather over grade 3. Additional CAL 133 information can be found on page 15.

6. Options

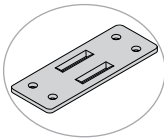
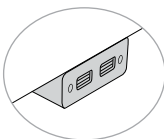
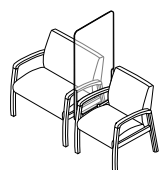
Ganging Brackets	Code	Price	
Ganging Brackets	XGV	+ \$103	
Power Options	Code	Price	
Power, Left	PFL	+ \$250	
Power, Right	PFR	+ \$250	
Screen	Code	Price	
Sector Seating Screen	3097 XRX	+ \$460	

7. Packaging

Packaging	Code	Price
Fully Assembled in a Carton	P1	+ \$0

EFFECTIVE OCTOBER 17, 2022 | GSA SIN #: 33721

SPECIFICATIONS

Model:	VRP SW21 21" Seat	VRP SW24 24" Seat	VRP SW30 30" Seat
Dimensions			
Height	44"	44"	44"
Width	24.5"	27.5"	33.5"
Depth	26.5"	26.5"	26.5"
Arm Height (Height of Arms From Floor)	25.75"	25.75"	25.75"
Arm Height (From Seat to Top of Arm)	7.25"	7.25"	7.25"
Width Between Arms	20.75"	23.75"	29.75"
Seat Width	21.75"	24.75"	30.75"
Seat Depth	19"	19"	19"
Seat Height	18.5"	18.5"	18.5"
Back Height	28.5"	28.5"	28.5"
Materials			
COM (Fully Upholstered)	2.8 yd	2.8 yd	3.8 yd
COM (Multi-Upholstery)			
Seat Only	1.2 yd	1.2 yd	1.2 yd
Back Only	1.9 yd	2.2 yd	2.5 yd
COL (Fully Upholstered)	35 sq ft	43.4 sq ft	50 sq ft
Weight and Capacity			
Weight	42 lb (FM3)	44 lb (FM3)	57 lb (FM3)
	37 lb (FM1/FM2)	39 lb (FM1/FM2)	52 lb (FM1/FM2)
Weight Capacity Warranty	500 lb	500 lb	750 lb

Metal frame (FM3), Beech wood frame (FM2), Maple wood frame (FM1).

Yardage requirements for COM and COL are for solid and non-directional fabrics. Additional material may be required for larger repeating patterns.



Bariatric

Aviera

FREESPAN MULTISEATING

Comfort that lasts.

Whether lobby, lounge, welcoming or waiting, you can rest easy with supremely comfortable do-it-all seating for your public spaces. Aviera makes it easy to configure endlessly and effortlessly—across an entire collection—with worry-free design and lasting durability, including metal or wood frames that feature an integrated steel structure. Discover an industry-leading seating solution and get peace of mind for any project.



Metal 2-Seat

EFFECTIVE OCTOBER 17, 2022

Featured Models

METAL 2-SEAT :: \$2,551

Metal frame, 21" seat, open arms, polyurethane arm caps, multi-upholstery, grade 3 vinyl seat and grade 5 vinyl back

WOOD 2-SEAT :: \$2,915

Maple frame, 21" seat, open arms, no arm caps, multi-upholstery, grade 2 vinyl seat and grade 7 fabric back

METAL 3-SEAT :: \$3,521

Metal frame, 24" seat, center arm, open arms, polyurethane arm caps, multi-upholstery, grade 4 vinyl seat and grade 2 fabric back

Features

- Easy ingress and egress with waterfall seat design
- Clean-out space
- Steel-frame construction with metal-to-metal connections
- Beveled, wall-saving frame design
- Two frame materials: Durable aluminum frame or wood frame with silver ion anti-microbial finish
- Three metal frame finishes or four wood frame finishes
- Polyurethane, wood or solid surface arm caps
- Replaceable parts including seat, back, arms, arm caps and arm insets.
- 2-Seat: 525 lb weight capacity warranty
3-Seat: 750 lb weight capacity warranty

1. Product

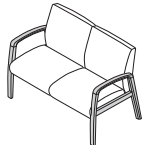
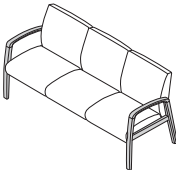
Model	Code	Price	
Aviera 2-Seat Freespan	VRF SN2	\$1,830	
Aviera 3-Seat Freespan	VRF SN3	\$2,731	

FREESPAN MULTISEATING

2. Frame

Frame Material	Code	Price	
Metal	FM3	+ \$0	
Wood			
Beech	FM2	+ \$10	
Maple	FM1	+ \$68	
Center Arm	Code	Price	
No Center Arm	AC0	+ \$0	

2-Seat With Center Arm	AC1	+ \$30	
------------------------	-----	--------	---

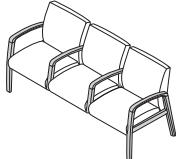
3-Seat With Center Arm	AC1	+ \$60	
------------------------	-----	--------	---

Frame Finish	Code	Price	
For Metal Frame			
Silver Metallic	FCM1	+ \$0	
Graphite	FCM2	+ \$0	
Taupe	FCM3	+ \$0	
For Wood Frame			
Clear Maple	FCW1	+ \$0	
Medium Cherry	FCW2	+ \$0	
Amber Mahogany	FCW3	+ \$0	
Espresso	FCW4	+ \$0	
Stain-to-Match	STM	+ \$70	
New Custom Stain	STL	+ \$275	

Frame Options	Code	Price	
Protective Guard Clear Tape	FX1	+ \$84	

New Custom Stain (STL): If stain is not in our library, add this one-time \$275 net fee in addition to the \$70 stain-to-match (STM) cost.

3. Seat

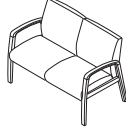
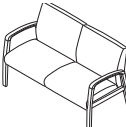
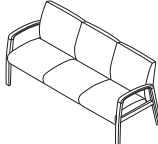
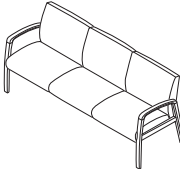
Seat Width	Code	Price	
21", 2-Seat (525 lb Weight Capacity)	SW21	+ \$0	
24", 2-Seat (525 lb Weight Capacity)	SW21	+ \$110	
21", 3-Seat (750 lb Weight Capacity)	SW24	+ \$0	
24", 3-Seat (750 lb Weight Capacity)	SW24	+ \$165	

See the Super Duty Guide on page 591 for additional high weight capacity products.

4. Arms

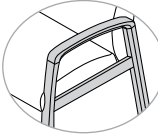
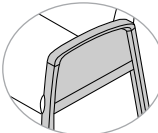
Arm Type	Code	Price	
Open Arm	AT1	+ \$0	
Upholstered Arm, 2-Seat No Center Arm	AT2	+ \$86	
Upholstered Arm, 2-Seat With Center Arm	AT2	+ \$129	
Upholstered Arm, 3-Seat No Center Arm	AT2	+ \$86	
Upholstered Arm, 3-Seat With Center Arm	AT2	+ \$172	

Upholstered arm textile will match seat textile.

FREESPAN MULTISEATING

4. Arms (Cont.)

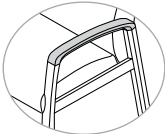
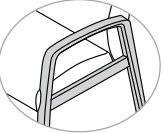
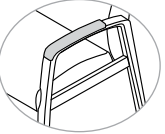
Arm Cap Material	Code	Price	
For Metal Frame			
Polyurethane	ACP4	+ \$0	
Wood, No Center Arm	ACP3	+ \$80	
Wood, 2-Seat With Center Arm	ACP3	+ \$120	
Wood, 3-Seat With Center Arm	ACP3	+ \$160	
Solid Surface No Center Arm	ACP5	+ \$450	
Solid Surface, 2-Seat With Center Arm	ACP5	+ \$675	
Solid Surface, 3-Seat With Center Arm	ACP5	+ \$900	
For Wood Frame			
No Arm Cap	ACP0	+ \$0	
Polyurethane, No Center Arm	ACP2	+ \$120	
Polyurethane, 2-Seat With Center Arm	ACP2	+ \$180	
Polyurethane, 3-Seat With Center Arm	ACP2	+ \$240	
Arm Cap Finish	Code	Price	
For Polyurethane Arm Caps			
Black	RMC3	+ \$0	
Fog	RMC4	+ \$0	
Dark Grey	RMC5	+ \$0	
For Wood Arm Caps			
Clear Maple	FCW1	+ \$0	
Medium Cherry	FCW2	+ \$0	
Amber Mahogany	FCW3	+ \$0	
Espresso	FCW4	+ \$0	
Stain-to-Match	STM	+ \$70	
New Custom Stain	STL	+ \$275	
For Solid Surface Arm Caps			
Designer White	TSS2	+ \$0	

New Custom Stain (STL): If stain is not in our library, add this one-time \$275 net fee in addition to the \$70 stain-to-match (STM) cost.

5. Material

Protection	Code	Price	
Fire Retardancy		2-Seat	3-Seat
CAL 133	UCAL	+ \$200	+ \$300
Cleaning	Code	Price	
Moisture Barrier		2-Seat	3-Seat
Seat Only	UM2	+ \$130	+ \$195
Back Only	UM1	+ \$130	+ \$195
Seat and Back	UM3	+ \$260	+ \$390
Fully Upholstered	Code	Price	
Seat and Back Textile		2-Seat	3-Seat
Fabric/Vinyl Grade 1	FG1/VG1	+ \$0	+ \$0
COM	COM	+ \$120	+ \$180
Fabric/Vinyl Grade 2	FG2/VG2	+ \$120	+ \$180
Fabric/Vinyl Grade 3	FG3/VG3	+ \$300	+ \$450
Fabric/Vinyl Grade 4	FG4/VG4	+ \$550	+ \$825
Fabric/Vinyl Grade 5	FG5/VG5	+ \$830	+ \$1,245
Fabric/Vinyl Grade 6	FG6/VG6	+ \$1,150	+ \$1,725
Fabric/Vinyl Grade 7	FG7/VG7	+ \$1,470	+ \$2,205
Leather Grade 1	LG1	+ \$1,200	+ \$1,800
COL	COL	+ \$1,400	+ \$2,100
Leather Grade 2	LG2	+ \$1,400	+ \$2,100
Leather Grade 3	LG3	+ \$1,600	+ \$2,400
Multi-Upholstery	Code	Price	
		2-Seat	3-Seat
Multi-Upholstery Upcharge	UMU	+ \$113	+ \$113
Seat Textile Only		2-Seat	3-Seat
Fabric/Vinyl Grade 1	FG1/VG1	+ \$0	+ \$0
COM	COM	+ \$51	+ \$76
Fabric/Vinyl Grade 2	FG2/VG2	+ \$51	+ \$76
Fabric/Vinyl Grade 3	FG3/VG3	+ \$126	+ \$189
Fabric/Vinyl Grade 4	FG4/VG4	+ \$231	+ \$347
Fabric/Vinyl Grade 5	FG5/VG5	+ \$349	+ \$523
Fabric/Vinyl Grade 6	FG6/VG6	+ \$483	+ \$725
Fabric/Vinyl Grade 7	FG7/VG7	+ \$618	+ \$927
Leather Grade 1	LG1	+ \$504	+ \$756
COL	COL	+ \$588	+ \$882
Leather Grade 2	LG2	+ \$588	+ \$882
Leather Grade 3	LG3	+ \$672	+ \$1,008

FREESPAN MULTISEATING

5. Material (Cont.)

Multi-Upholstery	Code	Price	
Back Textile Only		2-Seat	3-Seat
Fabric/Vinyl Grade 1	FG1/VG1	+ \$0	+ \$0
COM	COM	+ \$70	+ \$105
Fabric/Vinyl Grade 2	FG2/VG2	+ \$70	+ \$105
Fabric/Vinyl Grade 3	FG3/VG3	+ \$174	+ \$261
Fabric/Vinyl Grade 4	FG4/VG4	+ \$319	+ \$479
Fabric/Vinyl Grade 5	FG5/VG5	+ \$482	+ \$723
Fabric/Vinyl Grade 6	FG6/VG6	+ \$667	+ \$1,001
Fabric/Vinyl Grade 7	FG7/VG7	+ \$853	+ \$1,279
Leather Grade 1	LG1	+ \$696	+ \$1,044
COL	COL	+ \$812	+ \$1,218
Leather Grade 2	LG2	+ \$812	+ \$1,218
Leather Grade 3	LG3	+ \$928	+ \$1,392

Upholstery prices apply to both 21" and 24" models.

If different fabrics are selected for the seat and back, add the multi-upholstery upcharge as well, even if the fabrics are the same grade.

Please reference the Textile Reference Guide for pricing on fabric over grade 7 and leather over grade 3. Additional CAL 133 information can be found on page 15.

6. Options

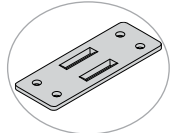
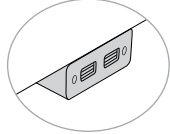
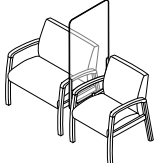
Ganging Brackets	Code	Price	
Ganging Brackets	XGV	+ \$103	
Power Options	Code	Price	
Power, Left	PFL	+ \$250	
Power, Right	PFR	+ \$250	
Sector Seating Screen	3097 XRX	+ \$460	

7. Packaging

Packaging	Code	Price
Fully Assembled in a Carton	P1	+ \$0

2-SEAT SPECIFICATIONS

Model:	21"	24"
Dimensions		
Height	34.5"	34.5"
Width	46.39" (AC0) 47.28" (AC1)	52.39" (AC0) 53.28" (AC1)
Depth	26.5"	26.5"
Arm Height (Height of Arms From Floor)	25.75"	25.75"
Arm Height (From Seat to Top of Arm)	7.25"	7.25"
Width Between Arms	42.64" (AC0) 20.75" (AC1)	48.64" (AC0) 23.75" (AC1)
Seat Width	21.75"	24.75"
Seat Depth	19"	19"
Seat Height	18.5"	18.5"
Back Height	18.5"	18.5"
Materials		
COM (Fully Upholstered)	3.8 yd	4.3 yd
COM (Multi-Upholstery)		
Seat Only	1.9 yd	2.2 yd
Back Only	2.1 yd	3.1 yd
COL (Fully Upholstered)	58 sq ft	86 sq ft
Weight and Capacity		
Weight	81 lb (FM3+AC0)	84 lb (FM3+AC0)
	85 lb (FM3+AC1)	88 lb (FM3+AC1)
	76 lb (FM1/FM2+AC0)	79 lb (FM1/FM2+AC0)
	79 lb (FM1/FM2+AC1)	82 lb (FM1/FM2+AC1)
Weight Capacity Warranty	525 lb	525 lb

Metal frame (FM3). Beech wood frame (FM2), Maple wood frame (FM2).
No center arms (AC0). Center arm (AC1).

Yardage requirements for COM and COL are for solid and non-directional fabrics. Additional material may be required for larger repeating patterns.

3-SEAT SPECIFICATIONS

Model:	21"	24"
Dimensions		
Height	34.5"	34.5"
Width	68.27" (AC0) 70.03" (AC1)	77.27" (AC0) 79.03" (AC1)
Depth	26.5"	26.5"
Arm Height (Height of Arms From Floor)	25.75"	25.75"
Arm Height (From Seat to Top of Arm)	7.25"	7.25"
Width Between Arms	64.52" (AC0) 20.75" (AC1)	73.52" (AC0) 23.75" (AC1)
Seat Width	21.75"	24.75"
Seat Depth	19"	19"
Seat Height	18.5"	18.5"
Back Height	18.5"	18.5"
Materials		
COM (Fully Upholstered)	5.6 yd	5.9 yd
COM (Multi-Upholstery)		
Seat Only	3 yd	3 yd
Back Only	3.1 yd	4.7 yd
COL (Fully Upholstered)	88.2 sq ft	93 sq ft
Weight and Capacity		
Weight	104 lb (FM3+AC0)	109 lb (FM3+AC0)
	110 lb (FM3+AC1)	117 lb (FM3+AC1)
	99 lb (FM1/FM2+AC0)	104 lb (FM1/FM2+AC0)
	105 lb (FM1/FM2+AC1)	110 lb (FM1/FM2+AC1)
Weight Capacity Warranty	750 lb	750 lb

Metal frame (FM3). Beech wood frame (FM2), Maple wood frame (FM3).
No center arms (AC0). Center arms (AC1).

Yardage requirements for COM and COL are for solid and non-directional fabrics. Additional material may be required for larger repeating patterns.



Metal 3-Seat

Aviera

PRECONFIGURED TANDEM MULTISEATING

Comfort that lasts.

Whether lobby, lounge, welcoming or waiting, you can rest easy with supremely comfortable do-it-all seating for your public spaces. Aviera makes it easy to configure endlessly and effortlessly—across an entire collection—with worry-free design and lasting durability, including metal or wood frames that feature an integrated steel structure. Discover an industry-leading seating solution and get peace-of-mind for any project.



Metal 2-Seat

EFFECTIVE OCTOBER 17, 2022

Featured Models

METAL 2-SEAT :: \$2,867

Metal frame, 21" seat, open arms, polyurethane arm caps, multi-upholstery, grade 4 vinyl seat and grade 5 vinyl back

WOOD 2-SEAT :: \$3,160

Maple frame, 21" seat, open arms, no arm caps, multi-upholstery, grade 2 vinyl seat and grade 7 fabric back

METAL 3-SEAT :: \$4,367

Metal frame, 21" seat, open arms, polyurethane arm caps, multi-upholstery, grade 1 vinyl seat and grade 7 vinyl back

Features

- Easy ingress and egress with waterfall seat design
- Clean-out space
- Steel-frame construction with metal-to-metal connections
- Beveled, wall-saving frame design
- Two frame materials: Durable aluminum frame or wood frame with silver ion anti-microbial finish
- Three metal frame finishes or four wood frame finishes
- Polyurethane, wood or solid surface arm caps
- Replaceable parts including seat, back, arms, arm caps and arm insets.
- 500 lb weight capacity (per seat) warranty

1. Product

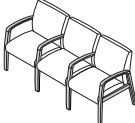
Model	Code	Price	
Aviera 2-Seat Preconfigured	VRC SN2	\$2,041	
Aviera 3-Seat Preconfigured	VRC SN3	\$2,975	

PRECONFIGURED TANDEM MULTISEATING

2. Frame

Frame Material	Code	Price	
Metal	FM3	+ \$0	
Wood			
Beech 2-Seat	FM2	+ \$15	
Beech 3-Seat	FM2	+ \$20	
Maple 2-Seat	FM1	+ \$102	
Maple 3-Seat	FM1	+ \$136	
Frame Finish	Code	Price	
For Metal Frame			
Silver Metallic	FCM1	+ \$0	
Graphite	FCM2	+ \$0	
Taupe	FCM3	+ \$0	
For Wood Frame			
Clear Maple	FCW1	+ \$0	
Medium Cherry	FCW2	+ \$0	
Amber Mahogany	FCW3	+ \$0	
Espresso	FCW4	+ \$0	
Stain-to-Match	STM	+ \$70	
New Custom Stain	STL	+ \$275	

Frame Options	Code	Price	
Protective Guard Clear Tape, 2-Seat	FX1	+ \$126	
Protective Guard Clear Tape, 3-Seat	FX1	+ \$168	

New Custom Stain (STL): If stain is not in our library, add this one-time \$275 net fee in addition to the \$70 stain-to-match (STM) cost.

3. Back

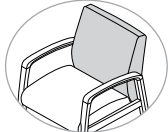

Back Height	Code	Price	
Guest Back	BH1	+ \$0	

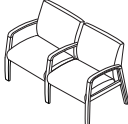
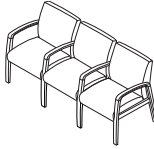
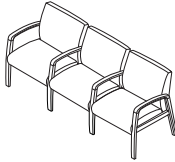
4. Seat

Seat Width	Code	Price	
21", 2-Seat (500 lb Weight Capacity, Per Seat)	SW21	+ \$0	
24", 2-Seat (500 lb Weight Capacity, Per Seat)	SW24	+ \$110	
21", 3-Seat (500 lb Weight Capacity, Per Seat)	SW21	+ \$0	
24", 3-Seat (500 lb Weight Capacity, Per Seat)	SW24	+ \$165	

See the Super Duty Guide on page 591 for additional high weight capacity products.

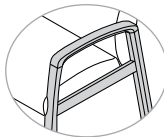
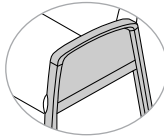
5. Arms

Arm Type	Code	Price	
Open Arm	AT1	+ \$0	
Upholstered Arm, 2-Seat	AT2	+ \$129	
Upholstered Arm, 3-Seat	AT2	+ \$172	

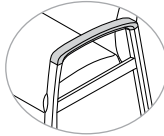
Arm Cap Material	Code	Price	
For Metal Frame			
Polyurethane	ACP4	+ \$0	
Wood, 2-Seat	ACP3	+ \$120	
Wood, 3-Seat	ACP3	+ \$160	
Solid Surface, 2-Seat	ACP5	+ \$675	
Solid Surface, 3-Seat	ACP5	+ \$900	

Upholstered arm textile will match seat textile.

PRECONFIGURED TANDEM MULTISEATING

5. Arms (Cont.)

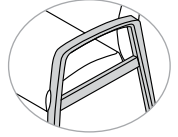
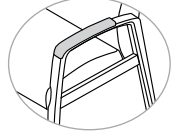
Arm Cap Material	Code	Price	
For Wood Frame			
No Arm Cap	ACP0	+ \$0	
Polyurethane, 2-Seat	ACP2	+ \$180	
Polyurethane, 3-Seat	ACP2	+ \$240	

Arm Cap Finish	Code	Price	
For Polyurethane Arm Caps			
Black	RMC3	+ \$0	
Fog	RMC4	+ \$0	
Dark Grey	RMC5	+ \$0	
For Wood Arm Caps			
Clear Maple	FCW1	+ \$0	
Medium Cherry	FCW2	+ \$0	
Amber Mahogany	FCW3	+ \$0	
Espresso	FCW4	+ \$0	
Stain-to-Match	STM	+ \$70	
New Custom Stain	STL	+ \$275	
For Solid Surface Arm Caps			
Designer White	TSS2	+ \$0	

Upholstered arm textile will match seat textile.

New Custom Stain (STL): If stain is not in our library, add this one-time \$275 net fee in addition to the \$70 stain-to-match (STM) cost.

6. Material

Protection	Code	Price	
Fire Retardancy		2-Seat	3-Seat
CAL 133	UCAL	+ \$200	+ \$300

Cleaning	Code	Price	
Moisture Barrier		2-Seat	3-Seat
Seat Only	UM2	+ \$130	+ \$195
Back Only	UM1	+ \$130	+ \$195
Seat and Back	UM3	+ \$260	+ \$390

6. Material (Cont.)

Fully Upholstered	Code	Price	
		2-Seat	3-Seat
Seat and Back Textile			
Fabric/Vinyl Grade 1	FG1/VG1	+ \$0	+ \$0
COM	COM	+ \$120	+ \$180
Fabric/Vinyl Grade 2	FG2/VG2	+ \$120	+ \$180
Fabric/Vinyl Grade 3	FG3/VG3	+ \$300	+ \$450
Fabric/Vinyl Grade 4	FG4/VG4	+ \$550	+ \$825
Fabric/Vinyl Grade 5	FG5/VG5	+ \$830	+ \$1,245
Fabric/Vinyl Grade 6	FG6/VG6	+ \$1,150	+ \$1,725
Fabric/Vinyl Grade 7	FG7/VG7	+ \$1,470	+ \$2,205
Leather Grade 1	LG1	+ \$1,200	+ \$1,800
COL	COL	+ \$1,400	+ \$2,100
Leather Grade 2	LG2	+ \$1,400	+ \$2,100
Leather Grade 3	LG3	+ \$1,600	+ \$2,400
Multi-Upholstery			
		Price	
		2-Seat	3-Seat
Multi-Upholstery Upcharge	UMU	+ \$113	+ \$113
Seat Textile Only			
		Price	
		2-Seat	3-Seat
Fabric/Vinyl Grade 1	FG1/VG1	+ \$0	+ \$0
COM	COM	+ \$51	+ \$76
Fabric/Vinyl Grade 2	FG2/VG2	+ \$51	+ \$76
Fabric/Vinyl Grade 3	FG3/VG3	+ \$126	+ \$189
Fabric/Vinyl Grade 4	FG4/VG4	+ \$231	+ \$347
Fabric/Vinyl Grade 5	FG5/VG5	+ \$349	+ \$523
Fabric/Vinyl Grade 6	FG6/VG6	+ \$483	+ \$725
Fabric/Vinyl Grade 7	FG7/VG7	+ \$618	+ \$927
Leather Grade 1	LG1	+ \$504	+ \$756
COL	COL	+ \$588	+ \$882
Leather Grade 2	LG2	+ \$588	+ \$882
Leather Grade 3	LG3	+ \$672	+ \$1,008

PRECONFIGURED TANDEM MULTISEATING

6. Material (Cont.)

Multi-Upholstery	Code	Price	
		2-Seat	3-Seat
Back Textile Only			
Fabric/Vinyl Grade 1	FG1/VG1	+ \$0	+ \$0
COM	COM	+ \$70	+ \$105
Fabric/Vinyl Grade 2	FG2/VG2	+ \$70	+ \$105
Fabric/Vinyl Grade 3	FG3/VG3	+ \$174	+ \$261
Fabric/Vinyl Grade 4	FG4/VG4	+ \$319	+ \$479
Fabric/Vinyl Grade 5	FG5/VG5	+ \$482	+ \$723
Fabric/Vinyl Grade 6	FG6/VG6	+ \$667	+ \$1,001
Fabric/Vinyl Grade 7	FG7/VG7	+ \$853	+ \$1,279
Leather Grade 1	LG1	+ \$696	+ \$1,044
COL	COL	+ \$812	+ \$1,218
Leather Grade 2	LG2	+ \$812	+ \$1,218
Leather Grade 3	LG3	+ \$928	+ \$1,392

Upholstery prices apply to both 21" and 24" models.

If different fabrics are selected for the seat and back, add the multi-upholstery upcharge as well, even if the fabrics are the same grade.

Please reference the *Textile Reference Guide* for pricing on fabric over grade 7 and leather over grade 3. Additional CAL 133 information can be found on page 15.

7. Options

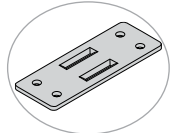
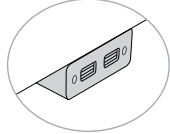
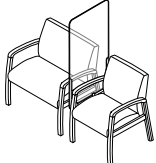
Ganging Brackets	Code	Price	
Ganging Brackets	XGV	+ \$103	
Power Options			
Power, Left	PFL	+ \$250	
Power, Right	PFR	+ \$250	
Sector Seating Screen	3097 XRX	+ \$460	

8. Packaging

Packaging	Code	Price	
		2-Seat	3-Seat
Packaging Options			
Final Assembly Required	P3	+ \$0	+ \$0
Fully Assembled in a Carton	P1	+ \$200	+ \$325

PRECONFIGURED TANDEM MULTISEATING

SPECIFICATIONS: 2-SEAT

Model:	21"	24"
Dimensions		
Height	34.5"	34.5"
Width	47.19"	53.19"
Depth	26.5"	26.5"
Arm Height (Height of Arms From Floor)	25.75"	25.75"
Arm Height (From Seat to Top of Arm)	7.25"	7.25"
Width Between Arms	20.75"	23.75"
Seat Width	21.75"	24.75"
Seat Depth	19"	19"
Seat Height	18.5"	18.5"
Back Height	18.5"	18.5"
Materials		
COM (Fully Upholstered)	3.8 yd	4.3 yd
COM (Multi-Upholstery)		
Seat Only	1.9 yd	2.2 yd
Back Only	2.1 yd	3.1 yd
COL (Fully Upholstered)	58 sq ft	86 sq ft
Weight and Capacity		
Weight	38 lb (FM3) 33 lb (FM1/FM2)	40 lb (FM3) 35 lb (FM1/FM2)
Weight Capacity (Per Seat) Warranty	500 lb	500 lb

Metal frame (FM3). Beech wood frame (FM2), Maple wood frame (FM1).

Yardage requirements for COM and COL are for solid and non-directional fabrics. Additional material may be required for larger repeating patterns.

SPECIFICATIONS: 3-SEAT

Model:	21"	24"
Dimensions		
Height	34.5"	34.5"
Width	69.85"	78.85"
Depth	26.5"	26.5"
Arm Height (Height of Arms From Floor)	25.75"	25.75"
Arm Height (From Seat to Top of Arm)	7.25"	7.25"
Width Between Arms	20.75"	20.75"
Seat Width	21.75"	24.75"
Seat Depth	19"	19"
Seat Height	18.5"	18.5"
Back Height	18.5"	18.5"
Materials		
COM (Fully Upholstered)	5.6 yd	5.9 yd
COM (Multi-Upholstery)		
Seat Only	3 yd	3 yd
Back Only	3.1 yd	4.7 yd
COL (Fully Upholstered)	88.2 sq ft	93 sq ft
Weight and Capacity		
Weight	99 lb (FM3) 89 lb (FM1/FM2)	104 lb (FM3) 94 lb (FM1/FM2)
Weight Capacity (Per Seat) Warranty	500 lb	500 lb

Metal frame (FM3). Beech wood frame (FM2), Maple wood frame (FM1).

Yardage requirements for COM and COL are for solid and non-directional fabrics. Additional material may be required for larger repeating patterns.



Wood 2-Seat

Aviera

START/CENTER/END TANDEM MULTISEATING

Comfort that lasts.

Whether lobby, lounge, welcoming or waiting, you can rest easy with supremely comfortable do-it-all seating for your public spaces. Aviera makes it easy to configure endlessly and effortlessly—across an entire collection—with worry-free design and lasting durability, including metal or wood frames that feature an integrated steel structure. Discover an industry-leading seating solution and get peace-of-mind for any project.



Metal 4-Seat

EFFECTIVE OCTOBER 17, 2022

Featured Models

METAL 3-SEAT :: \$4,233

One 21" start, one 30" center, one 21" end, metal frame, open arms, polyurethane arm caps, multi-upholstery, grade 3 vinyl seat and back

METAL 4-SEAT :: \$5,130

One 21" start, two 21" centers, one 30" end, metal frame, open arms, polyurethane arm caps, multi-upholstery, grade 2 vinyl seat and back

WOOD 5-SEAT :: \$7,007



One 21" start, three 21" centers, one 30" end, maple frame, open arms, no arm caps, multi-upholstery, grade 3 vinyl seat and back

START/CENTER/END TANDEM MULTISEATING

Features

- Start/center/end multiseating is the most versatile and is designed for configurations requiring more than three seats
- Easy ingress and egress with 18.5" seat height and waterfall seat design
- Clean-out space
- Steel-frame construction with metal-to-metal connections
- Beveled, wall-saving frame design
- Two frame materials: Durable aluminum frame or wood frame with silver ion anti-microbial finish
- Three metal frame finishes or four wood frame finishes
- Polyurethane, wood or solid surface arm caps
- Replaceable parts including seat, back, arms, arm caps and arm insets
- 21"/24" seat: 500 lb weight capacity warranty
30"/44" seat: 750 lb weight capacity warranty

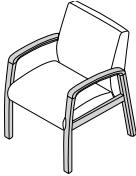
1. Product



Model	Code	Price	
Start	VRM FS4	\$1,054	
Center	VRM FS5	\$1,022	
End	VRM FS6	\$1,022	

2. Frame

Frame Material	Code	Price	
Metal	FM3	+ \$0	
Wood			
Beech, Start	FM2	+ \$10	
Maple, Start	FM1	+ \$68	
Beech, Center or End	FM2	+ \$5	
Maple, Center or End	FM1	+ \$34	
Frame Finish	Code	Price	
For Metal Frame			
Silver Metallic	FCM1	+ \$0	
Graphite	FCM2	+ \$0	
Taupe	FCM3	+ \$0	
For Wood Frame			
Clear Maple	FCW1	+ \$0	
Medium Cherry	FCW2	+ \$0	
Amber Mahogany	FCW3	+ \$0	
Espresso	FCW4	+ \$0	
Stain-to-Match	STM	+ \$70	
New Custom Stain	STL	+ \$275	
Frame Options	Code	Price	
Protective Guard Clear Tape, Start	FX1	+ \$84	
Protective Guard Clear Tape, Center/End	FX1	+ \$42	

New Custom Stain (STL): If stain is not in our library, add this one-time \$275 net fee in addition to the \$70 stain-to-match (STM) cost.

3. Seat

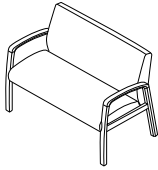
Seat Width	Code	Price	
21"	SW21	+ \$0	
24"	SW24	+ \$55	
Bariatric			
30"	SW30	+ \$275	
44"	SW44	+ \$500	

4. Back

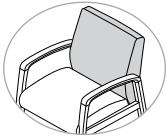
Back Height	Code	Price	
Guest Back	BH1	+ \$0	

5. Arms

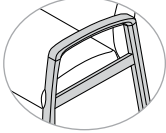
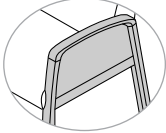
Arm Type	Code	Price	
Open Arm	AT1	+ \$0	
Upholstered Arm, Start	AT2	+ \$86	
Upholstered Arm, Center or End	AT2	+ \$43	

START/CENTER/END TANDEM MULTISEATING

5. Arms (Cont.)

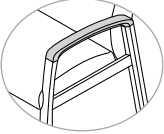
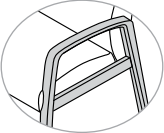
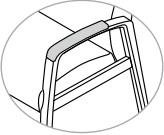
Arm Cap Material	Code	Price	
For Metal Frame			
Polyurethane	ACP4	+ \$0	
Wood, Start	ACP3	+ \$80	
Wood, Center/End	ACP3	+ \$40	
Solid Surface	ACP5	+ \$450	
Solid Surface, Center/End	ACP5	+ \$225	
For Wood Frame			
No Arm Cap	ACP0	+ \$0	
Polyurethane, Start	ACP2	+ \$120	
Polyurethane, Center/End	ACP2	+ \$60	
Arm Cap Finish	Code	Price	
For Polyurethane Arm Caps			
Black	RMC3	+ \$0	
Fog	RMC4	+ \$0	
Dark Grey	RMC5	+ \$0	
For Wood Arm Caps			
Clear Maple	FCW1	+ \$0	
Medium Cherry	FCW2	+ \$0	
Amber Mahogany	FCW3	+ \$0	
Espresso	FCW4	+ \$0	
Stain-to-Match	STM	+ \$70	
New Custom Stain	STL	+ \$275	
For Solid Surface Arm Caps			
Designer White	TSS2	+ \$0	

New Custom Stain (STL): If stain is not in our library, add this one-time \$275 net fee in addition to the \$70 stain-to-match (STM) cost.

START/CENTER/END TANDEM MULTISEATING

6. Material

Protection	Code	Price	
Fire Retardancy		21"/24"	30"/44"
CAL 133	UCAL	+ \$100	+ \$100
Cleaning	Code	Price	
Moisture Barrier		21"/24"	30"/44"
Seat Only	UM2	+ \$65	+ \$65
Back Only	UM1	+ \$65	+ \$65
Seat and Back	UM3	+ \$130	+ \$130
Fully Upholstered	Code	Price	
Seat and Back Textile		21"/24"	30"/44"
Fabric/Vinyl Grade 1	FG1/VG1	+ \$0	+ \$0
COM	COM	+ \$60	+ \$100
Fabric/Vinyl Grade 2	FG2/VG2	+ \$60	+ \$100
Fabric/Vinyl Grade 3	FG3/VG3	+ \$150	+ \$220
Fabric/Vinyl Grade 4	FG4/VG4	+ \$275	+ \$365
Fabric/Vinyl Grade 5	FG5/VG5	+ \$415	+ \$525
Fabric/Vinyl Grade 6	FG6/VG6	+ \$575	+ \$705
Fabric/Vinyl Grade 7	FG7/VG7	+ \$735	+ \$885
Leather Grade 1	LG1	+ \$600	+ \$685
COL	COL	+ \$700	+ \$805
Leather Grade 2	LG2	+ \$700	+ \$805
Leather Grade 3	LG3	+ \$800	+ \$1,005
Multi-Upholstery	Code	Price	
		21"/24"	30"/44"
Multi-Upholstery Upcharge	UMU	+ \$113	+ \$113
Seat Textile Only		21"/24"	30"/44"
Fabric/Vinyl Grade 1	FG1/VG1	+ \$0	+ \$0
COM	COM	+ \$26	+ \$42
Fabric/Vinyl Grade 2	FG2/VG2	+ \$26	+ \$42
Fabric/Vinyl Grade 3	FG3/VG3	+ \$63	+ \$93
Fabric/Vinyl Grade 4	FG4/VG4	+ \$116	+ \$154
Fabric/Vinyl Grade 5	FG5/VG5	+ \$175	+ \$221
Fabric/Vinyl Grade 6	FG6/VG6	+ \$242	+ \$297
Fabric/Vinyl Grade 7	FG7/VG7	+ \$309	+ \$372
Leather Grade 1	LG1	+ \$252	+ \$288
COL	COL	+ \$294	+ \$339
Leather Grade 2	LG2	+ \$294	+ \$339
Leather Grade 3	LG3	+ \$336	+ \$423

6. Material (Cont.)

Multi-Upholstery	Code	Price	
Back Textile Only		21"/24"	30"/44"
Fabric/Vinyl Grade 1	FG1/VG1	+ \$0	+ \$0
COM	COM	+ \$35	+ \$58
Fabric/Vinyl Grade 2	FG2/VG2	+ \$35	+ \$58
Fabric/Vinyl Grade 3	FG3/VG3	+ \$87	+ \$128
Fabric/Vinyl Grade 4	FG4/VG4	+ \$160	+ \$212
Fabric/Vinyl Grade 5	FG5/VG5	+ \$241	+ \$305
Fabric/Vinyl Grade 6	FG6/VG6	+ \$334	+ \$409
Fabric/Vinyl Grade 7	FG7/VG7	+ \$427	+ \$514
Leather Grade 1	LG1	+ \$348	+ \$398
COL	COL	+ \$406	+ \$467
Leather Grade 2	LG2	+ \$406	+ \$467
Leather Grade 3	LG3	+ \$464	+ \$583

If different fabrics are selected for the seat and back, add the multi-upholstery upcharge as well, even if the fabrics are the same grade.

Please reference the Textile Reference Guide for pricing on fabric over grade 7 and leather over grade 3. Additional CAL 133 information can be found on page 15.

7. Power

Power Options	Code	Price
Power, Left	PFL	+ \$250
Power, Right	PFR	+ \$250

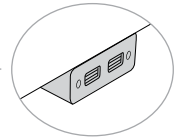

8. Packaging

Packaging	Code	Price
Fully Assembled in a Carton	P1	+ \$0

SPECIFICATIONS

Model:	21"	24"
Height	34.5"	34.5"
Width	24.5" (FS4) 22.66" (FS5/FS6)	27.5 (FS4) 25.66" (FS5/FS6)
Depth	26.5"	26.5"
Arm Height (Height of Arms From Floor)	25.75"	25.75"
Arm Height (From Seat to Top of Arm)	7.25"	7.25"
Width Between Arms	20.75"	23.75"
Seat Width	21.75"	24.75"
Seat Depth	19"	19"
Seat Height	18.5"	18.5"
Back Height	18.5"	18.5"
Weight	38 lb (FM3) 33 lb (FM1/FM2)	40 lb (FM3) 35 lb (FM1/FM2)
COM (Fully Upholstered)	1.9 yd	1.9 yd
COM (Multi-Upholstery)		
Seat Only	1.2 yd	1.2 yd
Back Only	1.1 yd	1.6 yd
COL (Fully Upholstered)	29.4 sq ft	43.4 sq ft
Weight Capacity Warranty	500 lb	500 lb

Start (FS4), Center (FS5), End (FS6), Metal frame (FM3), Beech wood frame (FM1), Maple wood frame (FM2).

Yardage requirements for COM and COL are for solid and non-directional fabrics. Additional material may be required for larger repeating patterns.

START/CENTER/END TANDEM MULTISEATING

SPECIFICATIONS: BARIATRIC SIZES

Model:	30"	44"
Height	34.5"	34.5"
Width	33.5" (FM4) 31.66" (FS5/FS6)	47.5 (FM4) 45.66" (FS5/FS6)
Depth	26.5"	26.5"
Arm Height (Height of Arms From Floor)	25.75"	25.75"
Arm Height (From Seat to Top of Arm)	7.25"	7.25"
Width Between Arms	29.75"	43.75"
Seat Width	30.75"	44.75"
Seat Depth	19"	19"
Seat Height	18.5"	18.5"
Back Height	18.5"	18.5"
Weight	50 lb (FM3+BH1) 45 lb (FM1/FM2+BH1)	77 lb (FM3+BH1) 73 lb (FM1/FM2+BH1)
COM (Fully Upholstered)	3.1 yd	3.4 yd
COM (Multi-Upholstery)		
Seat Only	1.2 yd	1.6 yd
Back Only	1.9 yd	1.9 yd
COL (Fully Upholstered)	47.6 sq ft	50.4 sq ft
Weight Capacity Warranty	750 lb	750 lb

Start (FS4), Center (FS5), End (FS6), Metal frame (FM3), Beech wood frame (FM1), Maple wood frame (FM2).

Yardage requirements for COM and COL are for solid and non-directional fabrics. Additional material may be required for larger repeating patterns.



Metal 5-Seat

Aviera

LINKING TABLES

High traffic. Low stress.

Tables are like bridges joining chairs and multiseating elements. Connect like items together or mix them up. For instance, a table can link to a guest or patient chair on one side and a preconfigured, freespan, start or end element on the other. In a start/center/end configuration, a table must connect to either a start or an end. End tables have two legs and 90° radius and square tables have one leg.



Wood Center Linking Table

EFFECTIVE OCTOBER 17, 2022

Featured Models

**WOOD CENTER
LINKING TABLE :: \$784**

Center linking table, maple, wood leg, maple wood veneer top and edge

**METAL LEG SQUARE
CORNER TABLE :: \$939**

Square 90-degree corner table, metal leg, laminate top with polymer edge finish



**SOLID SURFACE
END TABLE :: \$1,339**

End table, maple, metal leg, solid surface top and edge

Features

- Connects to Aviera Guest, Patient, and Multiseating options
- Four wood finishes and nine laminate colors
- Veener and solid surface top options

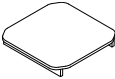
1. Appearance

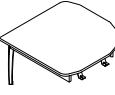
Table Type	Code	Price	
Center	VRL TTL1	\$784	
End	VRL TTL3	\$944	
Round 90-Degree Corner	VRL TTL4	\$969	
Square 90-Degree Corner	VRL TTL5	\$1,069	

2. Leg and Base

Leg and Base Material	Code	Price	
Wood	LM1	+ \$0	
Metal	LM2	+ \$0	
Leg and Base Finish	Code	Price	
Wood Finish			
Clear Maple	FCW1	+ \$0	
Medium Cherry	FCW2	+ \$0	
Amber Mahogany	FCW3	+ \$0	
Espresso	FCW4	+ \$0	
Stain-to-Match	STM	+ \$70	
New Custom Stain	STL	+ \$275	

New Custom Stain (STL): If stain is not in our library, add this one-time \$275 net fee in addition to the \$70 stain-to-match (STM) cost.

LINKING TABLES

2. Leg and Base (Cont.)

Leg and Base Finish	Code	Price	
Metal Finish			
Silver Metallic	FCM1	+ \$0	
Graphite	FCM2	+ \$0	
Taupe	FCM3	+ \$0	
Leg Options	Code	Price	
Protective Guard Clear Tape (Round or Square Table Type)	LX1	+ \$21	
Protective Guard Clear Tape (End Table Type)	LX1	+ \$42	

3. Tabletop

Tabletop and Edge Material	Code	Price	
Wood and Laminate			
Laminate Top With Polymer Edge	TM3	- \$130	
Beech Wood Veneer Top and Edge	TM2	- \$60	
Maple Wood Veneer Top and Edge	TM1	+ \$0	
Solid Surface			
Center or End Table	TM4	+ \$395	
Corner Table	TM4	+ \$640	
Tabletop Finish	Code	Price	
Laminate Color			
Fusion Maple Laminate	TL1	+ \$0	
Huntington Maple Laminate	TL2	+ \$0	
Cafelle Laminate	TL4	+ \$0	
Shaker Cherry Laminate	TL5	+ \$0	
Fonthill Pear Laminate	TL6	+ \$0	
Brighton Walnut Laminate	TL7	+ \$0	
Khaki Brown Laminate	TL9	+ \$0	
Slate Laminate	TL10	+ \$0	
Black Laminate	TL12	+ \$0	
Laminate-to-Match (10+ Units)	LMM	+ \$0	
Laminate-to-Match (Under 10 Units)	LMM	+ \$300	

3. Tabletop (Cont.)

Tabletop Finish	Code	Price
Wood Finish		
Clear Maple	FCW1	+ \$0
Medium Cherry	FCW2	+ \$0
Amber Mahogany	FCW3	+ \$0
Espresso	FCW4	+ \$0
Stain-to-Match	STM	+ \$70
New Custom Stain	STL	+ \$275
Solid Surface Finish		
Designer White	TSS2	+ \$0
Table Edge Finish	Code	Price
Polymer Finish		
Fusion Maple Polymer	TP1	+ \$0
Huntington Maple Polymer	TP2	+ \$0
Cafelle Polymer	TP4	+ \$0
Mocha Polymer	TP5	+ \$0
Fonthill Pear Polymer	TP6	+ \$0
Brighton Walnut Polymer	TP7	+ \$0
Khaki Brown Polymer	TP9	+ \$0
Slate Polymer	TP10	+ \$0
Black Polymer	TP12	+ \$0
Polymer-to-Match	PTM	+ \$0

New Custom Stain (STL): If stain is not in our library, add this one-time \$275 net fee in addition to the \$70 stain-to-match (STM) cost.

If laminate top is selected, wood finish will still need to be selected in addition to laminate color. Wood finish is applied to visible understructure.

Polymer finish pairs with laminate top (TM3) only.

LINKING TABLES

4. Packaging

Packaging	Code	Price
Knocked Down	P7	+ \$0

SPECIFICATIONS

Model:	VRL TTL3 End	VRL TTL1 Center	VRL TTL5 Square 90° Corner	VRL TTL4 Round 90° Corner
Height (From Floor)	16"	16"	16"	16"
Width	21"	22"	28.4"	31"
Depth	22"	22"	28.4"	31"
Weight (Complete Assembly)	11 lb	11 lb	18 lb	18 lb
Weight (Tabletop)	6.5 lb	6.5 lb	15 lb	15 lb



Solid Surface End Table

Aviera

EFFECTIVE
OCTOBER 17, 2022

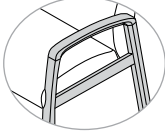
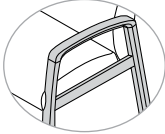
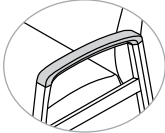
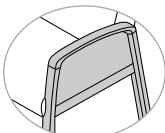

REPLACEMENT SEATING PARTS

Replacement Parts: Arms

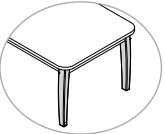

Part	Price	
Metal Arm		
Open Metal Arm, No Arm Cap	\$180	
Open Metal Arm, With Polyurethane Arm Cap	\$240	
Open Metal Arm, With Wood Arm Cap	\$280	
Open Metal Arm, With Solid Surface Arm Cap	\$680	
Open Beech Arm, No Arm Cap	\$190	
Open Maple Arm, No Arm Cap	\$210	
Arm Caps		
Polyurethane Arm Cap for Metal Frame	\$60	
Polyurethane Arm Cap for Wood Frame	\$160	
Arm Inset		
Upholstered Arm Inset	\$100	

Hip chair arms and Freespan center arms have separate pricing. All prices assume grade 1 textile. Please contact Customer Experience for additional information or to place an order.

Replacement Part: Tables

Part	Price	
Table Legs		
End Legs (2)	\$160	
Round or Square Corner Leg (1)	\$80	
Metal Leg (1)	\$120	

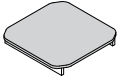
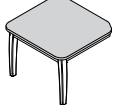
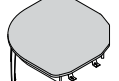
Replacement Part: Tables (Cont.)

Part	Price	
Laminate Top		
Center	\$627	
End	\$680	
Round 90-Degree Corner	\$740	
Square 90-Degree Corner	\$840	

Replacement Part: Upholstered

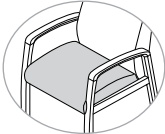
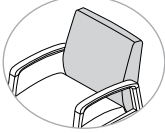
Part	Price	
Seat		
21"	\$428	
24"	\$455	
30"	\$557	
44"	\$664	
Guest Back		
21"	\$428	
24"	\$455	
30"	\$557	
44"	\$664	

All prices assume grade 1 textile. Please contact Customer Experience for additional information or to place an order.

Cameo

SEATING AND BENCHES

Design with distinction.

Tap into timeless beauty with a new take on an old classic. Cameo™ dares to move past tufted, boxy and overly square designs—both in shape and attitude. This inspired collection from world-renowned architect and designer Claudio Bellini balances perfect proportions of slenderness with just enough contouring so that it feels as good as it looks.



Seat



Armless Seat

EFFECTIVE OCTOBER 17, 2022

Featured Models

BENCH :: \$2,010

Cameo single seat bench, chrome base finish, grade 1 textile

ARMLESS SEAT :: \$2,191

Cameo single seat with no arms, charcoal base finish, grade 1 textile



SEAT :: \$2,416

Cameo single seat with dual arms, charcoal base finish, grade 1 textile

Features

- Add a lightweight, modern look with slim ribbon leg design
- Promotes all-around comfort with contoured seat, back and arms
- Choose between single seat, 2-seater, and 3-seater seats and benches
- Design for traditional and modular configurations
- Create single-arm, dual-arm and armless configurations
- Charcoal, bronze or chrome sled-leg bases
- Designed by Claudio Bellini
- Weight capacity warranty: 400 lb for single-seater; 800 lb for 2- and 3-seater

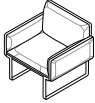
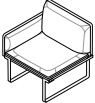
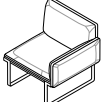
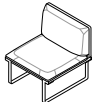
1. Product

Model	Code	Price	
Single Seat			
Single Seat With Dual Arms	CAM SN1 FS8	\$2,416	
Single Seat With Right Arm	CAM SN1 FS10	\$2,304	
Single Seat With Left Arm	CAM SN1 FS12	\$2,304	
Single Seat Armless	CAM SN1 FS17	\$2,191	
Single Seat Bench	CAM SN1 FS2	\$1,760	

SEATING AND BENCHES

1. Product (Cont.)

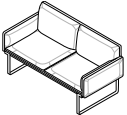
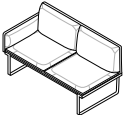
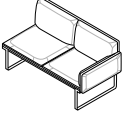
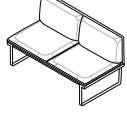
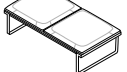
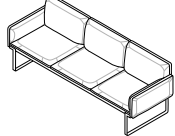
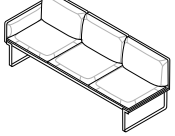
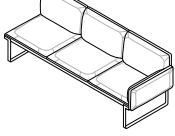
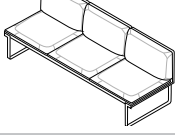
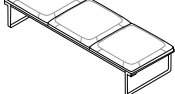
Model	Code	Price	
2-Seater			
2-Seater With Dual Arms	CAM SN2 FS8	\$3,660	
2-Seater With Right Arm	CAM SN2 FS10	\$3,547	
2-Seater With Left Arm	CAM SN2 FS12	\$3,547	
2-Seater Armless	CAM SN2 FS17	\$3,435	
2-Seater Bench	CAM SN2 FS2	\$2,441	
3-Seater			
3-Seater With Dual Arms	CAM SN3 FS8	\$4,716	
3-Seater With Right Arm	CAM SN3 FS10	\$4,604	
3-Seater With Left Arm	CAM SN3 FS12	\$4,604	
3-Seater Armless	CAM SN3 FS17	\$4,491	
3-Seater Bench	CAM SN3 FS2	\$3,498	

2. Base

Metal Finish	Code	Price
Charcoal	BF04	+ \$0
Bronze	BF05	+ \$0
Chrome	BF06	+ \$250

3. Material

Protection	Code	Price		
Fire Retardancy: Seats		1 Seat	2 Seats	3 Seats
CAL 133	UCAL	+ \$262	+ \$377	+ \$494
Fire Retardancy: Benches		1 Seat	2 Seats	3 Seats
CAL 133	UCAL	+ \$262	+ \$377	+ \$494
Cleaning	Code	Price		
Moisture Barrier: Seats		1 Seat	2 Seats	3 Seats
Seat Only	UM2	+ \$59	+ \$118	+ \$177
Back Only	UM1	+ \$59	+ \$118	+ \$177
Seat and Back	UM3	+ \$118	+ \$236	+ \$354
Moisture Barrier: Benches		1 Seat	2 Seats	3 Seats
Seat Only	UM2	+ \$59	+ \$118	+ \$177
Fully Upholstered	Code	Price		
Seat, Dual Arms		1 Seat	2 Seats	3 Seats
Fabric/Vinyl Grade 1	FG1/VG1	+ \$0	+ \$0	+ \$0
COM	COM	+ \$143	+ \$224	+ \$283
Fabric/Vinyl Grade 2	FG2/VG2	+ \$143	+ \$224	+ \$283
Fabric/Vinyl Grade 3	FG3/VG3	+ \$222	+ \$348	+ \$441
Fabric/Vinyl Grade 4	FG4/VG4	+ \$318	+ \$498	+ \$630
Fabric/Vinyl Grade 5	FG5/VG5	+ \$477	+ \$747	+ \$945
Fabric/Vinyl Grade 6	FG6/VG6	+ \$636	+ \$996	+ \$1,260
Fabric/Vinyl Grade 7	FG7/VG7	+ \$795	+ \$1,245	+ \$1,575
Leather Grade 1	LG1	+ \$1,575	+ \$2,475	+ \$2,850
COL	COL	+ \$1,995	+ \$3,135	+ \$3,610
Leather Grade 2	LG2	+ \$1,995	+ \$3,135	+ \$3,610
Leather Grade 3	LG3	+ \$2,520	+ \$3,960	+ \$4,560

SEATING AND BENCHES

3. Material (Cont.)

Fully Upholstered (Cont.)	Code	Price		
Seat, Single Arm		1 Seat	2 Seats	3 Seats
Fabric/Vinyl Grade 1	FG1/VG1	+ \$0	+ \$0	+ \$0
COM	COM	+ \$108	+ \$189	+ \$243
Fabric/Vinyl Grade 2	FG2/VG2	+ \$108	+ \$189	+ \$243
Fabric/Vinyl Grade 3	FG3/VG3	+ \$168	+ \$294	+ \$378
Fabric/Vinyl Grade 4	FG4/VG4	+ \$240	+ \$420	+ \$540
Fabric/Vinyl Grade 5	FG5/VG5	+ \$360	+ \$630	+ \$810
Fabric/Vinyl Grade 6	FG6/VG6	+ \$480	+ \$840	+ \$1,080
Fabric/Vinyl Grade 7	FG7/VG7	+ \$600	+ \$1,050	+ \$1,350
Leather Grade 1	LG1	+ \$1,200	+ \$2,175	+ \$2,625
COL	COL	+ \$1,520	+ \$2,755	+ \$3,325
Leather Grade 2	LG2	+ \$1,520	+ \$2,755	+ \$3,325
Leather Grade 3	LG3	+ \$1,920	+ \$3,480	+ \$4,200
Seat, Armless		1 Seat	2 Seats	3 Seats
Fabric/Vinyl Grade 1	FG1/VG1	+ \$0	+ \$0	+ \$0
COM	COM	+ \$81	\$162	+ \$216
Fabric/Vinyl Grade 2	FG2/VG2	+ \$81	\$162	+ \$216
Fabric/Vinyl Grade 3	FG3/VG3	+ \$126	\$252	+ \$336
Fabric/Vinyl Grade 4	FG4/VG4	+ \$180	\$360	+ \$480
Fabric/Vinyl Grade 5	FG5/VG5	+ \$270	\$540	+ \$720
Fabric/Vinyl Grade 6	FG6/VG6	+ \$360	\$720	+ \$960
Fabric/Vinyl Grade 7	FG7/VG7	+ \$450	\$900	+ \$1,200
Leather Grade 1	LG1	+ \$900	\$1,875	+ \$2,400
COL	COL	+ \$1,140	\$2,375	+ \$3,040
Leather Grade 2	LG2	+ \$1,140	\$2,375	+ \$3,040
Leather Grade 3	LG3	+ \$1,440	\$3,000	+ \$3,840
Bench		1 Seat	2 Seats	3 Seats
Fabric/Vinyl Grade 1	FG1/VG1	+ \$0	+ \$0	+ \$0
COM	COM	+ \$43	+ \$86	+ \$108
Fabric/Vinyl Grade 2	FG2/VG2	+ \$43	+ \$86	+ \$108
Fabric/Vinyl Grade 3	FG3/VG3	+ \$67	+ \$134	+ \$168
Fabric/Vinyl Grade 4	FG4/VG4	+ \$96	+ \$192	+ \$240
Fabric/Vinyl Grade 5	FG5/VG5	+ \$144	+ \$288	+ \$360
Fabric/Vinyl Grade 6	FG6/VG6	+ \$192	+ \$384	+ \$480
Fabric/Vinyl Grade 7	FG7/VG7	+ \$240	+ \$480	+ \$600
Leather Grade 1	LG1	+ \$525	+ \$1,050	+ \$1,260
COL	COL	+ \$665	+ \$1,330	+ \$1,596
Leather Grade 2	LG2	+ \$665	+ \$1,330	+ \$1,596
Leather Grade 3	LG3	+ \$840	+ \$1,680	+ \$2,016

3. Material (Cont.)

Multi-Upholstery	Code	Price		
		1 Seat	2 Seats	3 Seats
Multi-Upholstery Upcharge	UMU	+ \$75	+ \$75	+ \$75
Upholstered Seat Only		1 Seat	2 Seats	3 Seats
Fabric/Vinyl Grade 1	FG1/VG1	+ \$0	+ \$0	+ \$0
COM	COM	+ \$46	+ \$92	+ \$108
Fabric/Vinyl Grade 2	FG2/VG2	+ \$46	+ \$92	+ \$108
Fabric/Vinyl Grade 3	FG3/VG3	+ \$71	+ \$143	+ \$168
Fabric/Vinyl Grade 4	FG4/VG4	+ \$102	+ \$204	+ \$240
Fabric/Vinyl Grade 5	FG5/VG5	+ \$153	+ \$306	+ \$360
Fabric/Vinyl Grade 6	FG6/VG6	+ \$204	+ \$408	+ \$480
Fabric/Vinyl Grade 7	FG7/VG7	+ \$255	+ \$510	+ \$600
Leather Grade 1	LG1	+ \$525	+ \$1,050	+ \$1,200
COL	COL	+ \$665	+ \$1,330	+ \$1,520
Leather Grade 2	LG2	+ \$665	+ \$1,330	+ \$1,520
Leather Grade 3	LG3	+ \$840	+ \$1,680	+ \$1,920
Upholstered Back Only		1 Seat	2 Seats	3 Seats
Fabric/Vinyl Grade 1	FG1/VG1	+ \$0	+ \$0	+ \$0
COM	COM	+ \$38	+ \$76	+ \$101
Fabric/Vinyl Grade 2	FG2/VG2	+ \$38	+ \$76	+ \$101
Fabric/Vinyl Grade 3	FG3/VG3	+ \$59	+ \$118	+ \$157
Fabric/Vinyl Grade 4	FG4/VG4	+ \$84	+ \$168	+ \$225
Fabric/Vinyl Grade 5	FG5/VG5	+ \$126	+ \$252	+ \$337
Fabric/Vinyl Grade 6	FG6/VG6	+ \$168	+ \$336	+ \$450
Fabric/Vinyl Grade 7	FG7/VG7	+ \$210	+ \$420	+ \$562
Leather Grade 1	LG1	+ \$420	+ \$840	+ \$1,125
COL	COL	+ \$532	+ \$1,064	+ \$1,425
Leather Grade 2	LG2	+ \$532	+ \$1,064	+ \$1,425
Leather Grade 3	LG3	+ \$672	+ \$1,344	+ \$1,800
Upholstered Single Arm Only		1 Seat	2 Seats	3 Seats
Fabric/Vinyl Grade 1	FG1/VG1	+ \$0	+ \$0	+ \$0
COM	COM	+ \$27	+ \$27	+ \$27
Fabric/Vinyl Grade 2	FG2/VG2	+ \$27	+ \$27	+ \$27
Fabric/Vinyl Grade 3	FG3/VG3	+ \$42	+ \$42	+ \$42
Fabric/Vinyl Grade 4	FG4/VG4	+ \$60	+ \$60	+ \$60
Fabric/Vinyl Grade 5	FG5/VG5	+ \$90	+ \$90	+ \$90
Fabric/Vinyl Grade 6	FG6/VG6	+ \$120	+ \$120	+ \$120
Fabric/Vinyl Grade 7	FG7/VG7	+ \$150	+ \$150	+ \$150
Leather Grade 1	LG1	+ \$300	+ \$300	+ \$300
COL	COL	+ \$380	+ \$380	+ \$380
Leather Grade 2	LG2	+ \$380	+ \$380	+ \$380
Leather Grade 3	LG3	+ \$480	+ \$480	+ \$480

SEATING AND BENCHES

3. Material (Cont.)

Multi-Upholstery	Code	Price		
		1 Seat	2 Seats	3 Seats
Upholstered Dual Arms Only		1 Seat	2 Seats	3 Seats
Fabric/Vinyl Grade 1	FG1/VG1	+ \$0	+ \$0	+ \$0
COM	COM	+ \$54	+ \$54	+ \$54
Fabric/Vinyl Grade 2	FG2/VG2	+ \$54	+ \$54	+ \$54
Fabric/Vinyl Grade 3	FG3/VG3	+ \$84	+ \$84	+ \$84
Fabric/Vinyl Grade 4	FG4/VG4	+ \$120	+ \$120	+ \$120
Fabric/Vinyl Grade 5	FG5/VG5	+ \$180	+ \$180	+ \$180
Fabric/Vinyl Grade 6	FG6/VG6	+ \$240	+ \$240	+ \$240
Fabric/Vinyl Grade 7	FG7/VG7	+ \$300	+ \$300	+ \$300
Leather Grade 1	LG1	+ \$600	+ \$600	+ \$600
COL	COL	+ \$760	+ \$760	+ \$760
Leather Grade 2	LG2	+ \$760	+ \$760	+ \$760
Leather Grade 3	LG3	+ \$960	+ \$960	+ \$960

If different fabrics are selected for the seat and back, add the multiple upholstery upcharge (UMU) as well, even if the two fabrics are the same grade.

Please reference the Textile Reference Guide for pricing on fabric over grade 7 and leather over grade 3. Additional CAL 133 information can be found on page 15.

4. Miscellaneous

Accessories	Code	Price
Ganging Bracket	CAM XGV	+ \$52

One set of gangers (2 brackets) is included in this kit and can be installed on the left or right side of a seat or bench.

These two brackets are enough to gang two upholstered units together (benches or lounge units with or without an arm on the ganged side).

The inline table (CAMT TTL1) and the corner table (CAMT TTL4) are shipped standard with a total of two sets of gangers (4 brackets) to be supported between two upholstered units.

Order multiple quantities if ganging more than two pieces together.

Note: Ganging brackets are field installed.

5. Packaging

Packaging	Code	Price
Partially Assembled in Carton	P3	+ \$0

Leg ships unattached.

SEATING AND BENCHES

SPECIFICATIONS: SEATS WITH DUAL ARMS

Model:	CAM SN1 FS8 Single-Seat	CAM SN2 FS8 2-Seater	CAM SN3 FS8 3-Seater
Dimensions			
Height	30"	30"	30"
Width	32.75"	60"	86.6"
Depth	28"	28"	28"
Seat Depth	20.25"	20.25"	20.25"
Seat Height	16.75"	16.75"	16.75"
Back Height	13.25"	13.25"	13.25"
Materials			
COM (Single Upholstery)	5 yd	7.5 yd	10.5 yd
COM (Multi-Upholstery)			
Seat Only	1.75 yd	3.25 yd	5 yd
Back Only	1.6 yd	3 yd	4.75 yd
Arms Only	2.25 yd	2.25 yd	2.25 yd
COL (Single Upholstery)	99 sq ft	147 sq ft	170 sq ft
COL (Multi-Upholstery)			
Seat Only	31 sq ft	63 sq ft	80 sq ft
Back Only	31 sq ft	57 sq ft	75 sq ft
Arms Only	42 sq ft	42 sq ft	42 sq ft
Weight and Capacity			
Weight	75 lb	116 lb	169 lb
Weight Capacity Warranty	400 lb	800 lb	800 lb

SPECIFICATIONS: ARMLESS SEATS

Model:	CAM SN1 FS17 Single-Seat	CAM SN2 FS17 2-Seater	CAM SN3 FS17 3-Seater
Dimensions			
Height	30"	30"	30"
Width	27.5"	54.5"	81.5"
Depth	28"	28"	28"
Seat Depth	20.25"	20.25"	20.25"
Seat Height	16.75"	16.75"	16.75"
Back Height	13.25"	13.25"	13.25"
Materials			
COM (Fully Upholstered)	3.25 yd	5.75 yd	8 yd
COM (Multi-Upholstery)			
Seat Only	1.75 yd	3.25 yd	5 yd
Back Only	1.6 yd	3 yd	4.75 yd
COL (Fully Upholstered)	63 sq ft	115 sq ft	130 sq ft
COL (Multi-Upholstery)			
Seat Only	31 sq ft	63 sq ft	80 sq ft
Back Only	31 sq ft	57 sq ft	75 sq ft
Weight and Capacity			
Weight	54 lb	95 lb	148 lb
Weight Capacity Warranty	400 lb	800 lb	800 lb

SPECIFICATIONS: SEATS WITH SINGLE ARM

Model:	CAM SN1 FS10 CAM SN1 FS12 Single Seat	CAM SN2 FS10 CAM SN2 FS12 2-Seater	CAM SN3 FS10 CAM SN3 FS12 3-Seater
Dimensions			
Height	30"	30"	30"
Width	30"	57"	84"
Depth	28"	28"	28"
Seat Depth	20.25"	20.25"	20.25"
Seat Height	16.75"	16.75"	16.75"
Back Height	13.25"	13.25"	13.25"
Materials			
COM (Fully Upholstered)	4 yd	6.5 yd	9 yd
COM (Multi-Upholstery)			
Seat Only	1.75 yd	3.25 yd	5 yd
Back Only	1.6 yd	3 yd	4.75 yd
Arms Only	1.25 yd	1.25 yd	1.25 yd
COL (Fully Upholstered)	78 sq ft	126 sq ft	150 sq ft
COL (Multi-Upholstery)			
Seat Only	31 sq ft	63 sq ft	80 sq ft
Back Only	31 sq ft	57 sq ft	75 sq ft
Arms Only	26 sq ft	26 sq ft	26 sq ft
Weight and Capacity			
Weight	65 lb	105 lb	159 lb
Weight Capacity Warranty	400 lb	800 lb	800 lb

SPECIFICATIONS: BENCHES

Model:	CAM SN1 FS2 Single Seat	CAM SN2 FS2 2-Seater	CAM SN3 FS2 3-Seater
Dimensions			
Height	16.75"	16.75"	16.75"
Width	27.5"	54.5"	81.5"
Depth	28"	28"	28"
Seat Depth	28"	28"	28"
Seat Height	16.75"	16.75"	16.75"
Materials			
COM (Fully Upholstered)	2 yd	3.75 yd	5 yd
COL (Fully Upholstered)	36 sq ft	68 sq ft	84 sq ft
Weight and Capacity			
Weight	35 lb	56 lb	78 lb
Weight Capacity Warranty	400 lb	800 lb	800 lb

Cameo

INLINE AND COFFEE TABLES

Design with distinction.

Too many contemporary collections promise adaptable configurations but fall short. Cameo includes a wide variety of seats, benches and tables—for traditional and modular configurations that fit any space. Something truly mod-mod (at last).



Inline Table (Seats not Included)

EFFECTIVE OCTOBER 17, 2022

Featured Models

INLINE TABLE :: \$1,247

Cameo inline table, laminate tabletop, chrome base finish

CORNER TABLE :: \$1,328

Cameo corner table, laminate tabletop, bronze base finish

COFFEE TABLE :: \$2,478

Cameo rectangular coffee table, laminate tabletop, charcoal base finish

1. Product

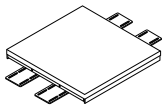
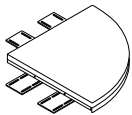
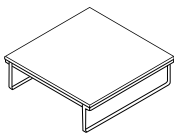
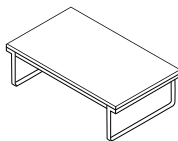
Model	Code	Price	
Inline Table	CAMT TTL1	\$997	
Corner Table	CAMT TTL4	\$1,328	
Square Coffee Table	CAMT TT8	\$2,478	
Rectangular Coffee Table	CAMT TT9	\$2,478	

The inline table (CAMT TTL1) and the corner table (CAMT TTL4) are shipped standard with a total of two sets of gangers (4 brackets) to be supported between two upholstered units.

2. Tabletop

Material	Code	Price	
Laminate	TM3	+ \$0	
Laminate Finish	Code	Price	
Classic Linen	TL17	Priced by Size	
Colombian Walnut	TL55	Priced by Size	
Crisp Linen	TL64	Priced by Size	
Designer White	TL66	Priced by Size	
Field Elm	TL13	Priced by Size	
Frosty White	TL16	Priced by Size	
Grey	TL62	Priced by Size	
Grey Elm	TL51	Priced by Size	
Kingswood Walnut	TL53	Priced by Size	
Manitoba	TL56	Priced by Size	
Neo Walnut	TL50	Priced by Size	
Platinum	TL61	Priced by Size	
Portico Teak	TL60	Priced by Size	
Skyline Walnut	TL15	Priced by Size	
Steel Mesh	TL59	Priced by Size	
Tuscan Walnut	TL57	Priced by Size	
Uptown Walnut	TL14	Priced by Size	

INLINE AND COFFEE TABLES

3. Table Base

Metal Finish	Code	Price	
Charcoal	BF04	+ \$0	
Bronze	BF05	+ \$0	
Chrome	BF06	+ \$250	

Finish also applies to the edge band.

4. Packaging

Packaging	Code	Price	
Partially Assembled in Carton	P3	+ \$0	

SPECIFICATIONS: LINKING TABLES

Model:	Inline Table	Corner Table
Width	27"	39.5"
Depth	28"	28.3"
Height	14.5"	14.5"
Weight	47 lb	44 lb

SPECIFICATIONS: COFFEE TABLES

Model:	Square Coffee Table	Rectangular Coffee Table
Dimensions		
Width	47.25"	47.3"
Depth	47.25"	27.8"
Height	14.5"	14.5"
Weight	120 lb	72 lb



Rectangular Coffee Table

Composium

CURVE CLUB CHAIR, SETTEE AND SOFA

Perfect harmony.

Transitional styling that blends well with collaboration areas and group housing defines Composium® Curve. This robust lounge seating collection offers three back styles, four valance styles and 11 foot styles to make it a comfortable seating choice for industrial, formal higher education or assisted living settings. Composium is rugged and easy to maintain with field-replaceable parts and durable steel-rail construction that withstands tough environments. Our PatternMatch® expertise ensures that every chair is a perfect match. Add an optional tablet arm or arm cap to create truly unique seating—just like you imagined.



Club Chair With Wood Tapered Feet

EFFECTIVE OCTOBER 17, 2022

Featured Models

CLUB CHAIR WITH PLASTIC FEET :: \$2,139

Composium Curve club chair, square back, arched valance, black plastic feet, fully upholstered, grade 1 textile

CLUB CHAIR WITH WOOD TAPERED FEET :: \$2,279

Composium Curve club chair, square back, full valance, wood tapered square feet, fully upholstered, grade 1 textile

SETTEE WITH WOOD SIDE RAILS :: \$3,204

Composium Curve settee, square back, integrated valance, wood tapered square feet with side rails, fully upholstered, grade 3 textile

Features

- Club, settee and sofa sizes
- PatternMatch® expertise and multi-upholstery options
- Durable steel-rail construction
- Three back types — square, round and scalloped
- Four valance styles — full, integrated, three-quarter and arched
- 11 foot styles including casters, metal pole and wood
- Optional clean-out space
- Sustainable manufacturing and Take Back Program
- 300 lb weight capacity warranty per seat
- Optional power module available

1. Product

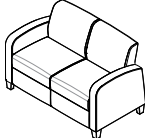
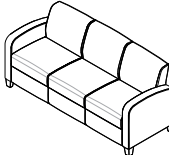
Model and Size	Code	Price	
Club	CP AS3 SN1	\$2,139	
Settee	CP AS3 SN2	\$2,771	
Sofa	CP AS3 SN3	\$3,381	

Order Composium ottoman and bench seating on page 104.

CURVE CLUB CHAIR, SETTEE AND SOFA

2. Back

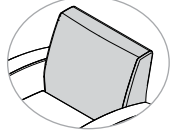
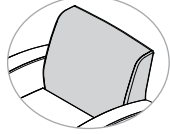
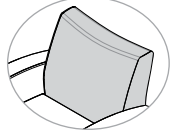
Back Shape	Code	Price	
Square	BS1	+\$0	
Round	BS2	+\$0	
Scalloped	BS3	+\$0	

3. Seat

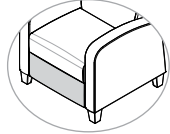
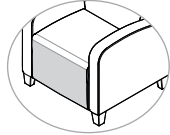
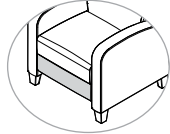
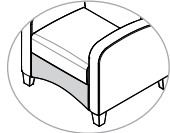
Valance Style	Code	Price	
Full	SV1	+\$0	
Integrated	SV2	+\$0	
Three-Quarter	SV3	+\$0	
Arched	SV4	+\$0	

3. Seat (Cont.)

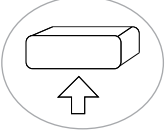
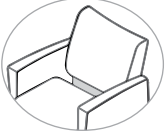
Seat Options	Code	Price	
Removable Cushion			
For Club Chair	SX1	+ \$59	
For Settee	SX1	+ \$118	
For Sofa	SX1	+ \$177	
Clean-Out			
For Club Chair	SX2	+ \$0	
For Settee	SX2	+ \$0	
For Sofa	SX2	+ \$0	





Removable cushion not available with clean-out or integrated valance.

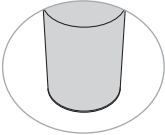
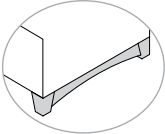
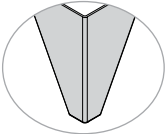
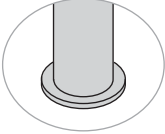
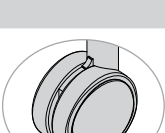
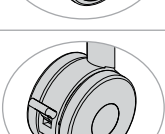

Club Chair With Plastic Feet

CURVE CLUB CHAIR, SETTEE AND SOFA

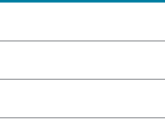
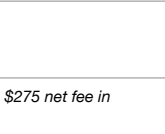
4. Foot

Foot Style and Color	Code	Price	
Feet			
Standard Plastic, Black	LS1	+ \$0	
Wood Tapered Square	LS12	+ \$140	
Wood Tapered Cylinder	LS11	+ \$140	
Wood Tapered Square With Side Rails	LS13	+ \$200	
Metal Angular, Brushed Aluminum	LS6	+ \$120	
Metal 1.5" Pole, Brushed Aluminum	LS7	+ \$120	
Metal 1.5" Pole, Silver Powder Coat	LS8	+ \$120	
Casters			
Non-Locking Caster, Black	LS2	+ \$100	
Non-Locking Caster, Silver	LS3	+ \$100	
Locking Caster, Black	LS4	+ \$120	
Locking Caster, Silver	LS5	+ \$120	



5. Frame (For Wooden Feet LS11/LS12/LS13)

Frame Finish Color	Code	Price	
Clear Maple	FCW1	+ \$0	
Medium Cherry	FCW2	+ \$0	
Amber Mahogany	FCW3	+ \$0	
Espresso	FCW4	+ \$0	
Stain-to-Match	STM	+ \$70	
New Custom Stain	STL	+ \$275	

New Custom Stain (STL): If stain is not in our library, add this one-time \$275 net fee in addition to the \$70 stain-to-match (STM) cost.

6. Power

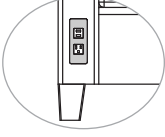
Power Location	Code	Price
Right Hand, Front of Unit	PFR	+ \$250
Left Hand, Front of Unit	PFL	+ \$250
Both Hands, Front of Unit	PFB	+ \$500

Power Color	Code	Price
Silver	PC2	+ \$0
Black	PC1	+ \$0

Power located on both hands (PFB) not available with club chair models (SN1).

7. Material

Protection	Code	Price
Fire Retardancy		Club Settee Sofa
CAL 133	UCAL	+ \$262 + \$377 + \$494

Cleaning	Code	Price
Moisture Barrier		Club Settee Sofa
Seat Only	UM2	+ \$59 + \$118 + \$177
Back Only	UM1	+ \$59 + \$118 + \$177
Seat and Back	UM3	+ \$118 + \$236 + \$354

Fully Upholstered	Code	Price
Seat, Back, Arm and Valance Textile		Club Settee Sofa
Fabric/Vinyl Grade 1	FG1/VG1	+ \$0 + \$0 + \$0
COM	COM	+ \$53 + \$78 + \$100
Fabric/Vinyl Grade 2	FG2/VG2	+ \$53 + \$78 + \$100
Fabric/Vinyl Grade 3	FG3/VG3	+ \$158 + \$233 + \$300
Fabric/Vinyl Grade 4	FG4/VG4	+ \$263 + \$388 + \$500
Fabric/Vinyl Grade 5	FG5/VG5	+ \$394 + \$582 + \$750
Fabric/Vinyl Grade 6	FG6/VG6	+ \$578 + \$853 + \$1,100
Fabric/Vinyl Grade 7	FG7/VG7	+ \$814 + \$1,202 + \$1,550
Leather Grade 1	LG1	+ \$834 + \$1,230 + \$1,592
COL	COL	+ \$1,095 + \$1,614 + \$2,089
Leather Grade 2	LG2	+ \$1,095 + \$1,614 + \$2,089
Leather Grade 3	LG3	+ \$1,512 + \$2,229 + \$2,885

CURVE CLUB CHAIR, SETTEE AND SOFA

7. Material (Cont)

Multi-Upholstery	Code	Price
		Club Settee Sofa
Multi-Upholstery Upcharge	UMU	+ \$113 + \$113 + \$113

Seat Textile Only	Code	Price
		Club Settee Sofa
Fabric/Vinyl Grade 1	FG1/VG1	+ \$0 + \$0 + \$0
COM	COM	+ \$8 + \$14 + \$20
Fabric/Vinyl Grade 2	FG2/VG2	+ \$8 + \$14 + \$20
Fabric/Vinyl Grade 3	FG3/VG3	+ \$23 + \$42 + \$60
Fabric/Vinyl Grade 4	FG4/VG4	+ \$39 + \$70 + \$100
Fabric/Vinyl Grade 5	FG5/VG5	+ \$58 + \$105 + \$150
Fabric/Vinyl Grade 6	FG6/VG6	+ \$84 + \$153 + \$220
Fabric/Vinyl Grade 7	FG7/VG7	+ \$119 + \$215 + \$310
Leather Grade 1	LG1	+ \$122 + \$221 + \$319
COL	COL	+ \$159 + \$289 + \$418
Leather Grade 2	LG2	+ \$159 + \$289 + \$418
Leather Grade 3	LG3	+ \$220 + \$399 + \$577

Back Textile Only	Code	Price
		Club Settee Sofa
Fabric/Vinyl Grade 1	FG1/VG1	+ \$0 + \$0 + \$0
COM	COM	+ \$15 + \$28 + \$40
Fabric/Vinyl Grade 2	FG2/VG2	+ \$15 + \$28 + \$40
Fabric/Vinyl Grade 3	FG3/VG3	+ \$44 + \$84 + \$118
Fabric/Vinyl Grade 4	FG4/VG4	+ \$72 + \$139 + \$197
Fabric/Vinyl Grade 5	FG5/VG5	+ \$108 + \$209 + \$295
Fabric/Vinyl Grade 6	FG6/VG6	+ \$159 + \$306 + \$432
Fabric/Vinyl Grade 7	FG7/VG7	+ \$224 + \$430 + \$609
Leather Grade 1	LG1	+ \$229 + \$441 + \$625
COL	COL	+ \$301 + \$578 + \$820
Leather Grade 2	LG2	+ \$301 + \$578 + \$820
Leather Grade 3	LG3	+ \$415 + \$798 + \$1,132

Arms Textile Only	Code	Price
		Club Settee Sofa
Fabric/Vinyl Grade 1	FG1/VG1	+ \$0 + \$0 + \$0
COM	COM	+ \$23 + \$23 + \$21
Fabric/Vinyl Grade 2	FG2/VG2	+ \$23 + \$23 + \$21
Fabric/Vinyl Grade 3	FG3/VG3	+ \$69 + \$67 + \$63
Fabric/Vinyl Grade 4	FG4/VG4	+ \$115 + \$111 + \$104
Fabric/Vinyl Grade 5	FG5/VG5	+ \$172 + \$166 + \$156
Fabric/Vinyl Grade 6	FG6/VG6	+ \$252 + \$243 + \$229
Fabric/Vinyl Grade 7	FG7/VG7	+ \$355 + \$342 + \$322
Leather Grade 1	LG1	+ \$364 + \$350 + \$331
COL	COL	+ \$477 + \$459 + \$434
Leather Grade 2	LG2	+ \$477 + \$459 + \$434
Leather Grade 3	LG3	+ \$659 + \$634 + \$600

7. Material (Cont.)

Multi-Upholstery (Cont.)	Code	Price		
		Club	Settee	Sofa
Valance Textile Only				
Fabric/Vinyl Grade 1	FG1/VG1	+ \$0	+ \$0	+ \$0
COM	COM	+ \$8	+ \$14	+ \$20
Fabric/Vinyl Grade 2	FG2/VG2	+ \$8	+ \$14	+ \$20
Fabric/Vinyl Grade 3	FG3/VG3	+ \$23	+ \$42	+ \$60
Fabric/Vinyl Grade 4	FG4/VG4	+ \$39	+ \$70	+ \$100
Fabric/Vinyl Grade 5	FG5/VG5	+ \$58	+ \$105	+ \$150
Fabric/Vinyl Grade 6	FG6/VG6	+ \$84	+ \$153	+ \$220
Fabric/Vinyl Grade 7	FG7/VG7	+ \$119	+ \$215	+ \$310
Leather Grade 1	LG1	+ \$122	+ \$221	+ \$319
COL	COL	+ \$159	+ \$289	+ \$418
Leather Grade 2	LG2	+ \$159	+ \$289	+ \$418
Leather Grade 3	LG3	+ \$220	+ \$399	+ \$577

If different fabrics are selected for the seat, back, arms and/or valance add the multiple upholstery upcharge (UMU) as well, even if the two fabrics are the same grade.

Please reference the Textile Reference Guide for pricing on fabric over grade 7 and leather over grade 3. Additional CAL 133 information can be found on page 15.

8. Packaging

Packaging	Code	Price
Fully Assembled in a Carton	P1	+ \$0

SPECIFICATIONS

Model:	Club CP AS3 SN1	Settee CP AS3 SN2	Sofa CP AS3 SN3
Dimensions			
Height	34"	34"	34"
Width	31"	53"	75"
Depth	28"	28"	28"
Seat Width	22"	44"	66"
Seat Depth	19.5"	19.5"	19.5"
Seat Height	19.5"	19.5"	19.5"
Back Height	16"	16"	16"
Arm Height	26"	26"	26"
Materials			
COM (Fully Upholstered)	5.3 yd	7.9 yd	10.5 yd
COM (Multi-Upholstery)			
Seat Only	1.9 yd	3.2 yd	3.8 yd
Back Only	2.2 yd	4.1 yd	5.8 yd
Arms Only	3.8 yd	3.8 yd	3.8 yd
Valance Only	1 yd	1.3 yd	1.3 yd
COL (Fully Upholstered)	83.3 sq ft	122.5 sq ft	163.7 sq ft
COL (Multi-Upholstery)			
Seat Only	29.4 sq ft	49 sq ft	58.8 sq ft
Back Only	33.4 sq ft	63.7 sq ft	90.2 sq ft
Arms Only	58.8 sq ft	58.8 sq ft	58.8 sq ft
Valance Only	14.7 sq ft	19.6 sq ft	19.6 sq ft
Weight and Capacity			
Weight	70 lb	115 lb	160 lb
Weight Capacity Warranty (Per Seat)	300 lb	300 lb	300 lb

Yardage requirements for COM and COL are for solid and non-directional fabrics. Additional material may be required for larger repeating patterns.



Settee With Wood Side Rails

Composium

FLAIR CLUB CHAIR, SETTEE AND SOFA

Perfect harmony.

Composium® Flair delivers contemporary elegance via the retro flair arm style. This robust lounge seating collection offers three back styles, four valance styles and 11 foot styles to make it a comfortable seating choice, from corporate to hospitality to higher education applications. Composium is rugged and easy to maintain with field-replaceable parts and durable steel-rail construction that withstands tough environments. Our PatternMatch® expertise ensures that every chair is a perfect match. Add an optional tablet arm or arm cap to create truly unique seating—just like you imagined.



Club Chair With Metal Pole Feet

EFFECTIVE OCTOBER 17, 2022

Featured Models

CLUB CHAIR WITH METAL POLE FEET :: \$2,307

Composium Flair club chair, scalloped back, full valance, brushed aluminum metal pole feet, fully upholstered, grade 2 vinyl

SETTEE WITH METAL POLE FEET :: \$2,891

Composium Flair settee, square back, three-quarter valance, brushed aluminum metal pole feet, fully upholstered, grade 1 textile



SOFA WITH WOOD FEET AND ARM CAPS :: \$4,143

Composium Flair sofa, square back, arched valance, wood arm caps, wood tapered square feet, fully upholstered, grade 4 textile

Features

- Club, settee and sofa sizes
- PatternMatch™ expertise and multi-upholstery options
- Durable steel-rail construction
- Three back types — square, round and scalloped
- Four valance styles — full, integrated, three-quarter and arched
- 11 foot styles including casters, metal pole and wood
- Optional clean-out space
- Optional wood arm cap and cushion
- Sustainable manufacturing and Take Back Program
- 300 lb weight capacity warranty per seat
- Optional power module available

1. Product

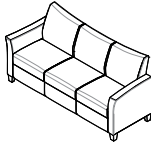
Model and Size	Code	Price	
Club	CP AS2 SN1	\$2,139	
Settee	CP AS2 SN2	\$2,771	
Sofa	CP AS2 SN3	\$3,381	

2. Arms

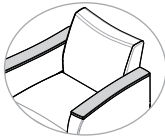
Arm Cap	Code	Price	
Wood Arm Cap	ACP1	+\$147	

FLAIR CLUB CHAIR, SETTEE AND SOFA

3. Back

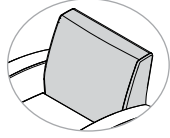
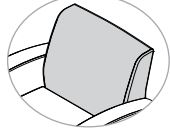
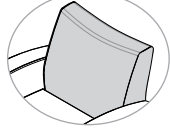
Back Shape	Code	Price	
Square	BS1	+\$0	
Round	BS2	+\$0	
Scalloped	BS3	+\$0	

4. Seat

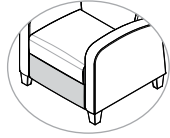
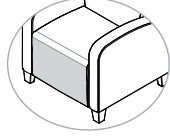
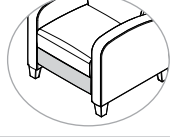
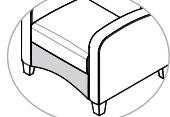
Valance Style	Code	Price	
Full	SV1	+\$0	
Integrated	SV2	+\$0	
Three-Quarter	SV3	+\$0	
Arched	SV4	+\$0	

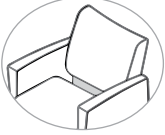

Removable Cushion	Code	Price	
For Club Chair	SX1	+\$59	
For Settee	SX1	+\$118	
For Sofa	SX1	+\$177	

4. Seat (Cont.)

Clean-Out	Code	Price	
For Club Chair	SX2	+ \$0	
For Settee	SX2	+ \$0	
For Sofa	SX2	+ \$0	

Removable cushion not available with clean-out or integrated valance.

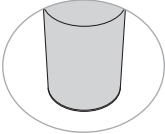
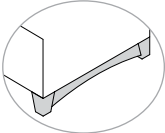
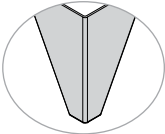
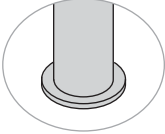
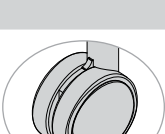
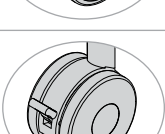
5. Foot

Foot Style and Color	Code	Price	
Feet			
Standard Plastic, Black	LS1	+ \$0	
Wood Tapered Square	LS12	+ \$140	
Wood Tapered Cylinder	LS11	+ \$140	
Wood Tapered Square With Side Rails	LS13	+ \$200	
Metal Angular, Brushed Aluminum	LS6	+ \$120	
Metal 1.5" Pole, Brushed Aluminum	LS7	+ \$120	
Metal 1.5" Pole, Silver Powder Coat	LS8	+ \$120	
Castors			
Non-Locking Caster, Black	LS2	+ \$100	
Non-Locking Caster, Silver	LS3	+ \$100	
Locking Caster, Black	LS4	+ \$120	
Locking Caster, Silver	LS5	+ \$120	



FLAIR CLUB CHAIR, SETTEE AND SOFA

6. Frame (For Wooden Feet LS11/LS12/LS13 or Tablet Arm AX1/AX4)

Frame Finish Color	Code	Price	
Clear Maple	FCW1	+ \$0	
Medium Cherry	FCW2	+ \$0	
Amber Mahogany	FCW3	+ \$0	
Espresso	FCW4	+ \$0	
Stain-to-Match	STM	+ \$70	
New Custom Stain	STL	+ \$275	

New Custom Stain (STL): If stain is not in our library, add this one-time \$275 net fee in addition to the \$70 stain-to-match (STM) cost.

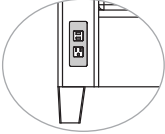
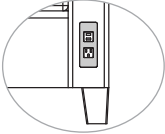
7. Power

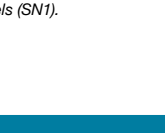
Power Location	Code	Price	
Right Hand, Front of Unit	PFR	+ \$250	
Left Hand, Front of Unit	PFL	+ \$250	
Both Hands, Front of Unit	PFB	+ \$500	
Power Color			
Silver	PC2	+ \$0	
Black	PC1	+ \$0	

Power located on both hands (PFB) not available with club chair models (SN1).

8. Material

Protection	Code	Price		
Fire Retardancy		Club	Settee	Sofa
CAL 133	UCAL	+ \$262	+ \$377	+ \$494
Cleaning		Price		
Moisture Barrier		Club	Settee	Sofa
Seat Only	UM2	+ \$59	+ \$118	+ \$177
Back Only	UM1	+ \$59	+ \$118	+ \$177
Seat and Back	UM3	+ \$118	+ \$236	+ \$354

8. Material (Cont.)

Fully Upholstered	Code	Price		
Seat, Back, Arm and Valance Textile		Club	Settee	Sofa
Fabric/Vinyl Grade 1	FG1/VG1	+ \$0	+ \$0	+ \$0
COM	COM	+ \$48	+ \$73	+ \$95
Fabric/Vinyl Grade 2	FG2/VG2	+ \$48	+ \$73	+ \$95
Fabric/Vinyl Grade 3	FG3/VG3	+ \$143	+ \$218	+ \$285
Fabric/Vinyl Grade 4	FG4/VG4	+ \$238	+ \$363	+ \$475
Fabric/Vinyl Grade 5	FG5/VG5	+ \$357	+ \$544	+ \$713
Fabric/Vinyl Grade 6	FG6/VG6	+ \$523	+ \$798	+ \$1,045
Fabric/Vinyl Grade 7	FG7/VG7	+ \$737	+ \$1,124	+ \$1,473
Leather Grade 1	LG1	+ \$758	+ \$1,154	+ \$1,516
COL	COL	+ \$995	+ \$1,515	+ \$1,990
Leather Grade 2	LG2	+ \$995	+ \$1,515	+ \$1,990
Leather Grade 3	LG3	+ \$1,374	+ \$2,092	+ \$2,748
Multi-Upholstery	Code	Price		
		Club	Settee	Sofa
Multi-Upholstery Upcharge	UMU	+ \$113	+ \$113	+ \$113
Seat Textile Only		Club	Settee	Sofa
Fabric/Vinyl Grade 1	FG1/VG1	+ \$0	+ \$0	+ \$0
COM	COM	+ \$7	+ \$13	+ \$19
Fabric/Vinyl Grade 2	FG2/VG2	+ \$7	+ \$13	+ \$19
Fabric/Vinyl Grade 3	FG3/VG3	+ \$21	+ \$39	+ \$57
Fabric/Vinyl Grade 4	FG4/VG4	+ \$35	+ \$65	+ \$95
Fabric/Vinyl Grade 5	FG5/VG5	+ \$52	+ \$98	+ \$143
Fabric/Vinyl Grade 6	FG6/VG6	+ \$76	+ \$143	+ \$209
Fabric/Vinyl Grade 7	FG7/VG7	+ \$107	+ \$202	+ \$295
Leather Grade 1	LG1	+ \$111	+ \$207	+ \$304
COL	COL	+ \$145	+ \$271	+ \$398
Leather Grade 2	LG2	+ \$145	+ \$271	+ \$398
Leather Grade 3	LG3	+ \$200	+ \$375	+ \$550

8. Material (Cont.)

Multi-Upholstery	Code	Price		
Back Textile Only		Club	Settee	Sofa
Fabric/Vinyl Grade 1	FG1/VG1	+ \$0	+ \$0	+ \$0
COM	COM	+ \$14	+ \$26	+ \$38
Fabric/Vinyl Grade 2	FG2/VG2	+ \$14	+ \$26	+ \$38
Fabric/Vinyl Grade 3	FG3/VG3	+ \$40	+ \$78	+ \$112
Fabric/Vinyl Grade 4	FG4/VG4	+ \$66	+ \$130	+ \$187
Fabric/Vinyl Grade 5	FG5/VG5	+ \$98	+ \$195	+ \$280
Fabric/Vinyl Grade 6	FG6/VG6	+ \$144	+ \$286	+ \$410
Fabric/Vinyl Grade 7	FG7/VG7	+ \$202	+ \$403	+ \$578
Leather Grade 1	LG1	+ \$208	+ \$413	+ \$595
COL	COL	+ \$273	+ \$542	+ \$781
Leather Grade 2	LG2	+ \$273	+ \$542	+ \$781
Leather Grade 3	LG3	+ \$377	+ \$749	+ \$1,078
Arms Textile Only		Club	Settee	Sofa
Fabric/Vinyl Grade 1	FG1/VG1	+ \$0	+ \$0	+ \$0
COM	COM	+ \$21	+ \$21	+ \$20
Fabric/Vinyl Grade 2	FG2/VG2	+ \$21	+ \$21	+ \$20
Fabric/Vinyl Grade 3	FG3/VG3	+ \$63	+ \$62	+ \$60
Fabric/Vinyl Grade 4	FG4/VG4	+ \$104	+ \$104	+ \$99
Fabric/Vinyl Grade 5	FG5/VG5	+ \$156	+ \$155	+ \$148
Fabric/Vinyl Grade 6	FG6/VG6	+ \$228	+ \$227	+ \$218
Fabric/Vinyl Grade 7	FG7/VG7	+ \$321	+ \$320	+ \$306
Leather Grade 1	LG1	+ \$331	+ \$328	+ \$315
COL	COL	+ \$434	+ \$431	+ \$414
Leather Grade 2	LG2	+ \$434	+ \$431	+ \$414
Leather Grade 3	LG3	+ \$599	+ \$595	+ \$571

8. Material (Cont.)

Multi-Upholstery	Code	Price		
		Club	Settee	Sofa
Valance Textile Only				
Fabric/Vinyl Grade 1	FG1/VG1	+ \$0	+ \$0	+ \$0
COM	COM	+ \$7	+ \$13	+ \$19
Fabric/Vinyl Grade 2	FG2/VG2	+ \$7	+ \$13	+ \$19
Fabric/Vinyl Grade 3	FG3/VG3	+ \$21	+ \$39	+ \$57
Fabric/Vinyl Grade 4	FG4/VG4	+ \$35	+ \$65	+ \$95
Fabric/Vinyl Grade 5	FG5/VG5	+ \$52	+ \$98	+ \$143
Fabric/Vinyl Grade 6	FG6/VG6	+ \$76	+ \$143	+ \$209
Fabric/Vinyl Grade 7	FG7/VG7	+ \$107	+ \$202	+ \$295
Leather Grade 1	LG1	+ \$111	+ \$207	+ \$304
COL	COL	+ \$145	+ \$271	+ \$398
Leather Grade 2	LG2	+ \$145	+ \$271	+ \$398
Leather Grade 3	LG3	+ \$200	+ \$375	+ \$550

If different fabrics are selected for the seat, back, arms and/or valance add the multiple upholstery upcharge (UMU) as well, even if the two fabrics are the same grade.

Please reference the Textile Reference Guide for pricing on fabric over grade 7 and leather over grade 3. Additional CAL 133 information can be found on page 15.

9. Packaging

Packaging	Code	Price
Fully Assembled in a Carton	P1	+ \$0

FLAIR CLUB CHAIR, SETTEE AND SOFA

SPECIFICATIONS

Model:	Club CP AS2 SN1	Settee CP AS2 SN2	Sofa CP AS2 SN3
Dimensions			
Height	34"	34"	34"
Width	33"	55"	77"
Depth	28"	28"	28"
Seat Width	22"	44"	66"
Seat Depth	19.5"	19.5"	19.5"
Seat Height	19.5"	19.5"	19.5"
Back Height	16"	16"	16"
Arm Height	26"	26"	26"
Materials			
COM (Fully Upholstered)	5.3 yd	7.9 yd	10.5 yd
COM (Multi-Upholstery)			
Seat Only	1.9 yd	3.2 yd	3.8 yd
Back Only	2.2 yd	4.1 yd	5.8 yd
Arms Only	3.8 yd	3.8 yd	3.8 yd
Valance Only	1 yd	1.3 yd	1.3 yd
COL (Fully Upholstered)	83.3 sq ft	122.5 sq ft	163.7 sq ft
COL (Multi-Upholstery)			
Seat Only	29.4 sq ft	49 sq ft	58.8 sq ft
Back Only	33.4 sq ft	63.7 sq ft	90.2 sq ft
Arms Only	58.8 sq ft	58.8 sq ft	58.8 sq ft
Valance Only	14.7 sq ft	19.6 sq ft	19.6 sq ft
Weight and Capacity			
Weight	70 lb	115 lb	160 lb
Weight Capacity Warranty (Per Seat)	300 lb	300 lb	300 lb

Yardage requirements for COM and COL are for solid and non-directional fabrics. Additional material may be required for larger repeating patterns.

Composium

SHARP CLUB CHAIR, SETTEE AND SOFA

Perfect harmony.

Composium® Sharp delivers harmonious contemporary style with straight lines and minimalist styling. This robust lounge seating collection offers three back styles, four valance styles and 11 foot styles to make it a comfortable seating choice for industrial, formal or higher education settings. Composium is rugged and easy to maintain with field-replaceable parts and durable steel-rail construction that withstands tough environments. Our PatternMatch® expertise ensures that every chair is a perfect match. Add an optional tablet arm or arm cap to create truly unique seating—just like you imagined.



Club Chair With Plastic Feet

Featured Models

CLUB CHAIR WITH PLASTIC FEET :: \$2,156

Composium Sharp club chair, square back, full valance, plastic feet, fully upholstered, grade 3 textile

SETTEE WITH METAL POLE FEET :: \$3,921

Composium Sharp settee, square back, three-quarter valance, brushed aluminum metal pole feet, fully upholstered, grade 7 textile

SOFA WITH WOOD SIDE RAILS :: \$4,960

Composium Sharp sofa, round back, arched valance, wood tapered square legs with side rails, fully upholstered, grade 7 textile

Features

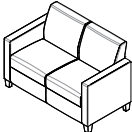
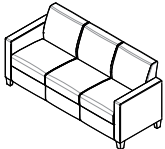

- Club, settee and sofa sizes
- PatternMatch expertise and multi-upholstery options
- Durable steel-rail construction
- Three back types — square, round and scalloped
- Four valance styles — full, integrated, three-quarter and arched
- 11 foot styles including casters, metal pole and wood
- Optional clean-out space
- Optional tablet arm and wood arm cap
- Sustainable manufacturing and Take Back Program
- 300 lb weight capacity warranty per seat
- Optional power module available

1. Product

Model and Size	Code	Price	
Club	CP AS1 SN1	\$2,006	
Settee	CP AS1 SN2	\$2,638	
Sofa	CP AS1 SN3	\$3,248	

SHARP CLUB CHAIR, SETTEE AND SOFA

2. Arms

Tablet Arm	Code	Price	
Tablet Arm, Right	AX1	+\$342	
Tablet Arm, Left	AX4	+\$342	

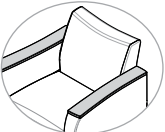
Arm Cap	Code	Price	
Wood Arm Cap	ACP1	+\$147	
Polyurethane Arm Cap	ACP2	+\$147	

Polyurethane arm (ACP2) is not available with tablet arm.

3. Back

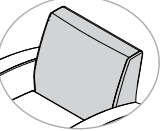
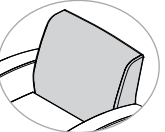
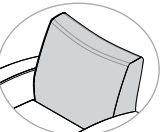
Back Shape	Code	Price	
Square	BS1	+\$0	
Round	BS2	+\$0	
Scalloped	BS3	+\$0	

COMPOSIUM SHARP

EFFECTIVE OCTOBER 17, 2022 | GSA SIN #: 33721

4. Seat

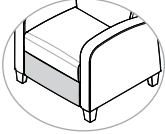
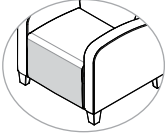
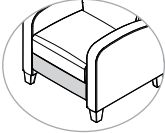
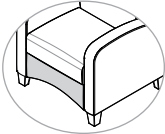
Valance Style	Code	Price	
Full	SV1	+ \$0	
Integrated	SV2	+ \$0	
Three-Quarter	SV3	+ \$0	
Arched	SV4	+ \$0	

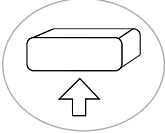

Removable Cushion	Code	Price	
For Club Chair	SX1	+ \$59	
For Settee	SX1	+ \$118	
For Sofa	SX1	+ \$177	

Clean-Out	Code	Price	
For Club Chair	SX2	+ \$0	
For Settee	SX2	+ \$0	
For Sofa	SX2	+ \$0	

Removable cushion not available with clean-out or integrated valance.

SHARP CLUB CHAIR, SETTEE AND SOFA

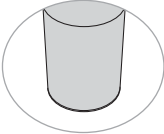
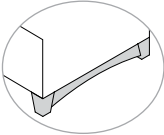
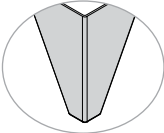
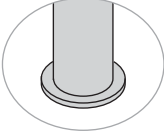
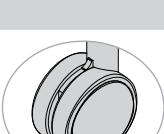
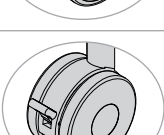
5. Foot

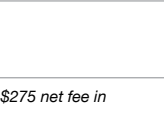
Foot Style and Color	Code	Price	
Feet			
Standard Plastic, Black	LS1	+ \$0	
Wood Tapered Square	LS12	+ \$140	
Wood Tapered Cylinder	LS11	+ \$140	
Wood Tapered Square With Side Rails	LS13	+ \$200	
Metal Angular, Brushed Aluminum	LS6	+ \$120	
Metal 1.5" Pole, Brushed Aluminum	LS7	+ \$120	
Metal 1.5" Pole, Silver Powder Coat	LS8	+ \$120	
Casters			
Non-Locking Caster, Black	LS2	+ \$100	
Non-Locking Caster, Silver	LS3	+ \$100	
Locking Caster, Black	LS4	+ \$120	
Locking Caster, Silver	LS5	+ \$120	

6. Frame (For Wooden Feet LS11/LS12/LS13 or Tablet Arm AX1/AX4)

Frame Finish Color	Code	Price	
Clear Maple	FCW1	+ \$0	
Medium Cherry	FCW2	+ \$0	
Amber Mahogany	FCW3	+ \$0	
Espresso	FCW4	+ \$0	
Stain-to-Match	STM	+ \$70	
New Custom Stain	STL	+ \$275	



New Custom Stain (STL): If stain is not in our library, add this one-time \$275 net fee in addition to the \$70 stain-to-match (STM) cost.

COMPOSIUM SHARP

EFFECTIVE OCTOBER 17, 2022 | GSA SIN #: 33721

7. Power

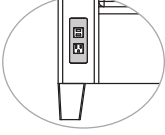
Power Location	Code	Price
Right Hand, Front of Unit	PFR	+ \$250
Left Hand, Front of Unit	PFL	+ \$250
Both Hands, Front of Unit	PFB	+ \$500

Power Color	Code	Price
Silver	PC2	+ \$0
Black	PC1	+ \$0

Power located on both hands (PFB) not available with club chair models (SN1).

8. Material

Protection	Code	Price		
Fire Retardancy		Club	Settee	Sofa
CAL 133	UCAL	+ \$262	+ \$377	+ \$494

Cleaning	Code	Price		
Moisture Barrier		Club	Settee	Sofa
Seat Only	UM2	+ \$59	+ \$118	+ \$177
Back Only	UM1	+ \$59	+ \$118	+ \$177
Seat and Back	UM3	+ \$118	+ \$236	+ \$354

Fully Upholstered	Code	Price		
Seat, Back, Arm and Valance Textile		Club	Settee	Sofa
Fabric/Vinyl Grade 1	FG1/VG1	+ \$0	+ \$0	+ \$0
COM	COM	+ \$50	+ \$75	+ \$98
Fabric/Vinyl Grade 2	FG2/VG2	+ \$50	+ \$75	+ \$98
Fabric/Vinyl Grade 3	FG3/VG3	+ \$150	+ \$225	+ \$293
Fabric/Vinyl Grade 4	FG4/VG4	+ \$250	+ \$375	+ \$488
Fabric/Vinyl Grade 5	FG5/VG5	+ \$375	+ \$563	+ \$732
Fabric/Vinyl Grade 6	FG6/VG6	+ \$550	+ \$825	+ \$1,073
Fabric/Vinyl Grade 7	FG7/VG7	+ \$775	+ \$1,163	+ \$1,512
Leather Grade 1	LG1	+ \$800	+ \$1,196	+ \$1,550
COL	COL	+ \$1,050	+ \$1,570	+ \$2,034
Leather Grade 2	LG2	+ \$1,050	+ \$1,570	+ \$2,034
Leather Grade 3	LG3	+ \$1,450	+ \$2,168	+ \$2,809

SHARP CLUB CHAIR, SETTEE AND SOFA

8. Material (Cont)

Multi-Upholstery	Code	Price		
		Club	Settee	Sofa
Multi-Upholstery Upcharge	UMU	+ \$113	+ \$113	+ \$113

Seat Textile Only		Code	Price		
			Club	Settee	Sofa
Fabric/Vinyl Grade 1		FG1/VG1	+ \$0	+ \$0	+ \$0
COM		COM	+ \$8	+ \$14	+ \$20
Fabric/Vinyl Grade 2		FG2/VG2	+ \$8	+ \$14	+ \$20
Fabric/Vinyl Grade 3		FG3/VG3	+ \$22	+ \$41	+ \$59
Fabric/Vinyl Grade 4		FG4/VG4	+ \$37	+ \$68	+ \$98
Fabric/Vinyl Grade 5		FG5/VG5	+ \$55	+ \$101	+ \$147
Fabric/Vinyl Grade 6		FG6/VG6	+ \$80	+ \$148	+ \$215
Fabric/Vinyl Grade 7		FG7/VG7	+ \$113	+ \$209	+ \$303
Leather Grade 1		LG1	+ \$117	+ \$214	+ \$310
COL		COL	+ \$153	+ \$281	+ \$407
Leather Grade 2		LG2	+ \$153	+ \$281	+ \$407
Leather Grade 3		LG3	+ \$211	+ \$388	+ \$562

Back Textile Only		Code	Price		
			Club	Settee	Sofa
Fabric/Vinyl Grade 1		FG1/VG1	+ \$0	+ \$0	+ \$0
COM		COM	+ \$14	+ \$27	+ \$39
Fabric/Vinyl Grade 2		FG2/VG2	+ \$14	+ \$27	+ \$39
Fabric/Vinyl Grade 3		FG3/VG3	+ \$42	+ \$81	+ \$115
Fabric/Vinyl Grade 4		FG4/VG4	+ \$69	+ \$135	+ \$192
Fabric/Vinyl Grade 5		FG5/VG5	+ \$103	+ \$202	+ \$287
Fabric/Vinyl Grade 6		FG6/VG6	+ \$151	+ \$296	+ \$421
Fabric/Vinyl Grade 7		FG7/VG7	+ \$213	+ \$417	+ \$593
Leather Grade 1		LG1	+ \$220	+ \$428	+ \$608
COL		COL	+ \$288	+ \$562	+ \$798
Leather Grade 2		LG2	+ \$288	+ \$562	+ \$798
Leather Grade 3		LG3	+ \$398	+ \$776	+ \$1,102

Arms Textile Only		Code	Price		
			Club	Settee	Sofa
Fabric/Vinyl Grade 1		FG1/VG1	+ \$0	+ \$0	+ \$0
COM		COM	+ \$22	+ \$22	+ \$21
Fabric/Vinyl Grade 2		FG2/VG2	+ \$22	+ \$22	+ \$21
Fabric/Vinyl Grade 3		FG3/VG3	+ \$66	+ \$64	+ \$61
Fabric/Vinyl Grade 4		FG4/VG4	+ \$109	+ \$107	+ \$102
Fabric/Vinyl Grade 5		FG5/VG5	+ \$164	+ \$160	+ \$152
Fabric/Vinyl Grade 6		FG6/VG6	+ \$240	+ \$235	+ \$223
Fabric/Vinyl Grade 7		FG7/VG7	+ \$338	+ \$331	+ \$314
Leather Grade 1		LG1	+ \$349	+ \$340	+ \$322
COL		COL	+ \$458	+ \$447	+ \$423
Leather Grade 2		LG2	+ \$458	+ \$447	+ \$423
Leather Grade 3		LG3	+ \$632	+ \$616	+ \$584

8. Material (Cont.)

Multi-Upholstery (Cont.)	Code	Price		
		Club	Settee	Sofa
Valance Textile Only				
Fabric/Vinyl Grade 1	FG1/VG1	+ \$0	+ \$0	+ \$0
COM	COM	+ \$8	+ \$14	+ \$20
Fabric/Vinyl Grade 2	FG2/VG2	+ \$8	+ \$14	+ \$20
Fabric/Vinyl Grade 3	FG3/VG3	+ \$22	+ \$41	+ \$59
Fabric/Vinyl Grade 4	FG4/VG4	+ \$37	+ \$68	+ \$98
Fabric/Vinyl Grade 5	FG5/VG5	+ \$55	+ \$101	+ \$147
Fabric/Vinyl Grade 6	FG6/VG6	+ \$80	+ \$148	+ \$215
Fabric/Vinyl Grade 7	FG7/VG7	+ \$113	+ \$209	+ \$303
Leather Grade 1	LG1	+ \$117	+ \$214	+ \$310
COL	COL	+ \$153	+ \$281	+ \$407
Leather Grade 2	LG2	+ \$153	+ \$281	+ \$407
Leather Grade 3	LG3	+ \$211	+ \$388	+ \$562

If different fabrics are selected for the seat, back, arms and/or valance add the multiple upholstery upcharge (UMU) as well, even if the two fabrics are the same grade.

Please reference the Textile Reference Guide for pricing on fabric over grade 7 and leather over grade 3. Additional CAL 133 information can be found on page 15.

9. Packaging

Packaging	Code	Price
Fully Assembled in a Carton	P1	+ \$0

SPECIFICATIONS

Model:	Club CP AS1 SN1	Settee CP AS1 SN2	Sofa CP AS1 SN3
Dimensions			
Height	34"	34"	34"
Width	31"	53"	75"
Depth	28"	28"	28"
Seat Width	22"	44"	66"
Seat Depth	19.5"	19.5"	19.5"
Seat Height	19.5"	19.5"	19.5"
Back Height	16"	16"	16"
Arm Height	26"	26"	26"
Materials			
COM (Fully Upholstered)	5.3 yd	7.9 yd	10.5 yd
COM (Multi-Upholstery)			
Seat Only	1.9 yd	3.2 yd	3.8 yd
Back Only	2.2 yd	4.1 yd	5.8 yd
Arms Only	3.8 yd	3.8 yd	3.8 yd
Valance Only	1 yd	1.3 yd	1.3 yd
COL (Fully Upholstered)	83.3 sq ft	122.5 sq ft	163.7 sq ft
COL (Multi-Upholstery)			
Seat Only	29.4 sq ft	49 sq ft	58.8 sq ft
Back Only	33.4 sq ft	63.7 sq ft	90.2 sq ft
Arms Only	58.8 sq ft	58.8 sq ft	58.8 sq ft
Valance Only	14.7 sq ft	19.6 sq ft	19.6 sq ft
Weight and Capacity			
Weight	70 lb	115 lb	160 lb
Weight Capacity Warranty (Per Seat)	300 lb	300 lb	300 lb

Yardage requirements for COM and COL are for solid and non-directional fabrics. Additional material may be required for larger repeating patterns.



Settee with Metal Pole Feet

Composium

OTTOMAN AND BENCHES

Perfect harmony.

This robust bench and ottoman collection complement all Composium® lounge seating models. Three bench sizes—plus an ottoman—provide strategic accents for a functional and modular seating solution. An optional removable cushion and 10 foot styles make this line a comfortable and stylish soft seating choice. Composium is rugged and easy to maintain with field-replaceable parts and durable steel-rail construction in benches that withstands tough environments. Our PatternMatch® expertise ensures that every chair is a perfect match.



1-Seat Bench With Wood Feet

EFFECTIVE OCTOBER 17, 2022

Featured Models

OTTOMAN WITH CASTERS :: \$1,168

Composium ottoman, non-locking casters, fully upholstered, grade 3 textile

1-SEAT BENCH WITH WOOD FEET :: \$1,524

Composium single-seat bench, wood tapered square feet, fully upholstered, grade 3 textile



2-SEAT BENCH WITH METAL POLE FEET :: \$1,819

Composium double-seat bench, brushed aluminum metal pole feet, fully upholstered, grade 3 vinyl

Features



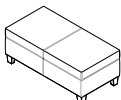
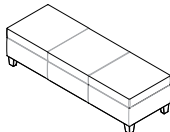

- Three bench sizes and an ottoman
- PatternMatch expertise and multi-upholstery options
- Durable steel-rail construction
- 11 foot styles including casters, metal pole and wood
- Sustainable manufacturing and Take Back Program
- 300 lb weight capacity warranty per seat
- Optional power module available

1. Product

Model	Code	Price	
Ottoman	CP FS1	\$1,000	
1-Seat Bench	CP FS2 SN1	\$1,309	
2-Seat Bench	CP FS2 SN2	\$1,609	
3-Seat Bench	CP FS2 SN3	\$1,909	

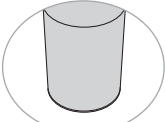
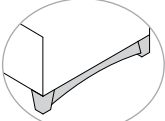
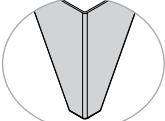
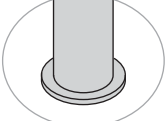
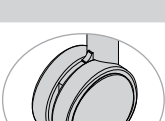
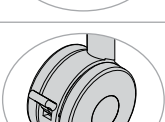
OTTOMAN AND BENCHES

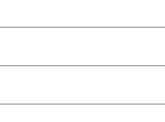
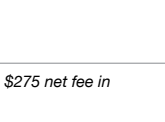
2. Foot

Foot Style and Color	Code	Price	
Feet			
Standard Plastic, Black	LS1	+ \$0	
Wood Tapered Square	LS12	+ \$140	
Wood Tapered Cylinder	LS11	+ \$140	
Wood Tapered Square With Side Rails	LS13	+ \$200	
Metal Angular, Brushed Aluminum	LS6	+ \$120	
Metal 1.5" Pole, Brushed Aluminum	LS7	+ \$120	
Metal 1.5" Pole, Silver Powder Coat	LS8	+ \$120	
Casters			
Non-Locking Caster, Black	LS2	+ \$100	
Non-Locking Caster, Silver	LS3	+ \$100	
Locking Caster, Black	LS4	+ \$120	
Locking Caster, Silver	LS5	+ \$120	

3. Frame (For Wooden Feet LS11/LS12/LS13)

Frame Finish Color	Code	Price	
Clear Maple	FCW1	+ \$0	
Medium Cherry	FCW2	+ \$0	
Amber Mahogany	FCW3	+ \$0	
Espresso	FCW4	+ \$0	
Stain-to-Match	STM	+ \$70	
New Custom Stain	STL	+ \$275	

New Custom Stain (STL): If stain is not in our library, add this one-time \$275 net fee in addition to the \$70 stain-to-match (STM) cost.

EFFECTIVE OCTOBER 17, 2022 | GSA SIN #: 33721

4. Power

Power Location	Code	Price
Right Hand, Front of Unit	PFR	+ \$250
Left Hand, Front of Unit	PFL	+ \$250
Both Hands, Front of Unit	PFB	+ \$500

Power Color	Code	Price
Silver	PC2	+ \$0
Black	PC1	+ \$0

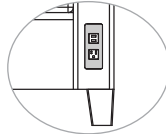
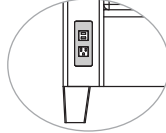

Ottoman with Casters

Power located on both hands (PFB) not available with ottoman (SN1) or single-seat bench models (SN1)

5. Material

Protection	Code	Price			
Fire Retardancy		Ottoman	1-Seat Bench	2-Seat Bench	3-Seat Bench
CAL 133	UCAL	+ \$88	+ \$88	+ \$175	+ \$262
Cleaning	Code	Price			
Moisture Barrier		Ottoman	1-Seat Bench	2-Seat Bench	3-Seat Bench
Seat Only	UM2	+ \$59	+ \$59	+ \$118	+ \$177
Fully Upholstered	Code	Price			
Seat and Valance Textile		Ottoman	1-Seat Bench	2-Seat Bench	3-Seat Bench
Fabric/Vinyl Grade 1	FG1/VG1	+ \$0	+ \$0	+ \$0	+ \$0
COM	COM	+ \$23	+ \$25	+ \$30	+ \$35
Fabric/Vinyl Grade 2	FG2/VG2	+ \$23	+ \$25	+ \$30	+ \$35
Fabric/Vinyl Grade 3	FG3/VG3	+ \$68	+ \$75	+ \$90	+ \$105
Fabric/Vinyl Grade 4	FG4/VG4	+ \$113	+ \$125	+ \$150	+ \$175
Fabric/Vinyl Grade 5	FG5/VG5	+ \$169	+ \$188	+ \$225	+ \$263
Fabric/Vinyl Grade 6	FG6/VG6	+ \$248	+ \$275	+ \$330	+ \$385
Fabric/Vinyl Grade 7	FG7/VG7	+ \$349	+ \$388	+ \$465	+ \$543
Leather Grade 1	LG1	+ \$363	+ \$371	+ \$447	+ \$523
COL	COL	+ \$476	+ \$487	+ \$586	+ \$686
Leather Grade 2	LG2	+ \$476	+ \$487	+ \$586	+ \$686
Leather Grade 3	LG3	+ \$657	+ \$672	+ \$809	+ \$947

EFFECTIVE OCTOBER 17, 2022 | GSA SIN #: 33721

5. Material (Cont.)

Multi-Upholstery	Code	Price			
		Ottoman	1-Seat Bench	2-Seat Bench	3-Seat Bench
Multi-Upholstery Upcharge	UMU	+ \$113	+ \$113	+ \$113	+ \$113
Seat Textile Only		Ottoman	1-Seat Bench	2-Seat Bench	3-Seat Bench
Fabric/Vinyl Grade 1	FG1/VG1	+ \$0	+ \$0	+ \$0	+ \$0
COM	COM	+ \$12	+ \$13	+ \$15	+ \$18
Fabric/Vinyl Grade 2	FG2/VG2	+ \$12	+ \$13	+ \$15	+ \$18
Fabric/Vinyl Grade 3	FG3/VG3	+ \$34	+ \$38	+ \$45	+ \$53
Fabric/Vinyl Grade 4	FG4/VG4	+ \$57	+ \$63	+ \$75	+ \$88
Fabric/Vinyl Grade 5	FG5/VG5	+ \$85	+ \$94	+ \$113	+ \$132
Fabric/Vinyl Grade 6	FG6/VG6	+ \$124	+ \$138	+ \$165	+ \$193
Fabric/Vinyl Grade 7	FG7/VG7	+ \$175	+ \$194	+ \$233	+ \$272
Leather Grade 1	LG1	+ \$182	+ \$186	+ \$224	+ \$262
COL	COL	+ \$238	+ \$244	+ \$293	+ \$343
Leather Grade 2	LG2	+ \$238	+ \$244	+ \$293	+ \$343
Leather Grade 3	LG3	+ \$329	+ \$336	+ \$405	+ \$474
Valance Textile Only		Ottoman	1-Seat Bench	2-Seat Bench	3-Seat Bench
Fabric/Vinyl Grade 1	FG1/VG1	+ \$0	+ \$0	+ \$0	+ \$0
COM	COM	+ \$12	+ \$13	+ \$15	+ \$18
Fabric/Vinyl Grade 2	FG2/VG2	+ \$12	+ \$13	+ \$15	+ \$18
Fabric/Vinyl Grade 3	FG3/VG3	+ \$34	+ \$38	+ \$45	+ \$53
Fabric/Vinyl Grade 4	FG4/VG4	+ \$57	+ \$63	+ \$75	+ \$88
Fabric/Vinyl Grade 5	FG5/VG5	+ \$85	+ \$94	+ \$113	+ \$132
Fabric/Vinyl Grade 6	FG6/VG6	+ \$124	+ \$138	+ \$165	+ \$193
Fabric/Vinyl Grade 7	FG7/VG7	+ \$175	+ \$194	+ \$233	+ \$272
Leather Grade 1	LG1	+ \$182	+ \$186	+ \$224	+ \$262
COL	COL	+ \$238	+ \$244	+ \$293	+ \$343
Leather Grade 2	LG2	+ \$238	+ \$244	+ \$293	+ \$343
Leather Grade 3	LG3	+ \$329	+ \$336	+ \$405	+ \$474

If different fabrics are selected for the seat and valance add the multiple upholstery upcharge (UMU) as well, even if the two fabrics are the same grade.

Please reference the Textile Reference Guide for pricing on fabric over grade 7 and leather over grade 3. Additional CAL 133 information can be found on page 15.

6. Packaging

Packaging	Code	Price
Fully Assembled in a Carton	P1	+ \$0

SPECIFICATIONS

Model:	CP FS1 Ottoman	CP FS2 SN1 1-Seat Bench
Dimensions		
Seat Width	22"	26"
Seat Depth	22"	24"
Seat Height	18.5"	18.5"
Materials		
COM (Fully Upholstered)	3.2 yd	3.2 yd
COM (Multi-Upholstery)		
Seat Only	1.9 yd	1.9 yd
Valance Only	1.9 yd	1.9 yd
COL (Fully Upholstered)	49 sq ft	49 sq ft
COL (Multi-Upholstery)		
Seat Only	29.4 sq ft	29.4 sq ft
Valance Only	29.4 sq ft	29.4 sq ft
Weight and Capacity		
Weight	28 lb	60 lb
Weight Capacity		
Warranty (Per Seat)	300 lb	300 lb

NOTE: Yardage requirements for COM and COL are for solid and non-directional fabrics. Additional material may be required for larger repeating patterns.

OTTOMAN AND BENCHES

SPECIFICATIONS

Model:	CP FS2 SN2 2-Seat Bench	CP FS2 SN3 3-Seat Bench
Dimensions		
Seat Width	48"	70"
Seat Depth	24"	24"
Seat Height	18.5"	18.5"
Materials		
COM (Fully Upholstered)	3.8 yd	4.4 yd
COM (Multi-Upholstery)		
Seat Only	2.9 yd	2.9 yd
Valance Only	2.9 yd	2.9 yd
COL (Fully Upholstered)	58.8 sq ft	68.6 sq ft
COL (Multi-Upholstery)		
Seat Only	44.1 sq ft	44.1 sq ft
Valance Only	44.1 sq ft	44.1 sq ft
Weight and Capacity		
Weight	91 lb	106 lb
Weight Capacity		
Warranty (Per Seat)	300 lb	300 lb

NOTE: Yardage requirements for COM and COL are for solid and non-directional fabrics. Additional material may be required for larger repeating patterns.



2-Seat Bench With Metal Pole Feet

Envoi

LOUNGE SEATING

Lean back lounge.

To reach the height of comfort, you should start at its roots. A place where everything feels natural and effortless. Get ready to discover what's possible when innovation comes to life because this is the first-ever flexing solution for lounge. It moves you. It moves with you. Envoi is a pure exposition of comfort-meets-motion with unmatched, unencumbered design.



Highback With Wood Base

EFFECTIVE OCTOBER 17, 2022

Featured Models

MIDBACK WITH METAL BASE :: \$2,030

Midback, 360-degree swivel, charcoal metal base, fully upholstered, grade 1 textile

HIGHBACK WITH METAL BASE :: \$2,404

Highback, 360-degree swivel, polished aluminum metal base, fully upholstered, grade 3 textile



HIGHBACK WITH WOOD BASE :: \$2,781

Highback, 360-degree swivel, wood base, fully upholstered, grade 4 textile

Features

- Designed by Claudio Bellini
- Backrest flexes and moves when you recline
- Petal-like pieces surround with comfort
- Available in midback or highback
- 4-star base available in three wood or metal finishes
- Auto-return cylinder available on metal base only
- 300 lb weight capacity warranty

1. Product

Back Size and Style	Code	Price	
Midback Lounge	ENV BH4	\$2,030	
Highback Lounge	ENV BH5	\$2,171	

2. Base

Cylinder	Code	Price	
360-Degree Swivel	CH5	+ \$0	
Auto-Return, Fixed Height	CH6	+ \$25	

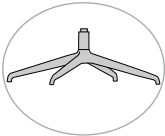
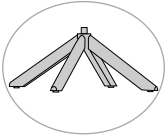
Base Material	Code	Price	
Metal	BMM	+ \$0	
Wood	BMW	+ \$400	

Auto-return cylinder (CH6) is only available with metal base (BMM).

LOUNGE SEATING

2. Base (Cont.)

Base Color	Code	Price	
Metal Color			
Charcoal	BF04	+ \$0	
Bronze	BF05	+ \$0	
Polished Aluminum	BF07	+ \$113	
Wood Cap Stain			
Uptown	BF08	+ \$0	
Colombian	BF09	+ \$0	
Skyline	BF10	+ \$0	

3. Material

Protection	Code	Price	
Fire Retardancy			
CAL 133	UCAL	+\$262	
Cleaning			
Moisture Barrier			
Seat Only	UM2	+\$59	
Back Only	UM1	+\$59	
Seat and Back	UM3	+\$118	
Fully Upholstered			
Midback (For BH4) Textile			
Fabric/Vinyl Grade 1	FG1/VG1	+ \$0	
COM	COM	+ \$42	
Fabric/Vinyl Grade 2	FG2/VG2	+ \$42	
Fabric/Vinyl Grade 3	FG3/VG3	+ \$112	
Fabric/Vinyl Grade 4	FG4/VG4	+ \$196	
Fabric/Vinyl Grade 5	FG5/VG5	+ \$336	
Fabric/Vinyl Grade 6	FG6/VG6	+ \$476	
Fabric/Vinyl Grade 7	FG7/VG7	+ \$616	
Leather Grade1	LG1	+ \$900	
COL	COL	+ \$1,140	
Leather Grade 2	LG2	+ \$1,140	
Leather Grade 3	LG3	+ \$1,440	

LOUNGE SEATING

3. Material (Cont.)

Fully Upholstered	Code	Price
Highback (For BH5) Textile		
Fabric/Vinyl Grade 1	FG1/VG1	+ \$0
COM	COM	+ \$45
Fabric/Vinyl Grade 2	FG2/VG2	+ \$45
Fabric/Vinyl Grade 3	FG3/VG3	+ \$120
Fabric/Vinyl Grade 4	FG4/VG4	+ \$210
Fabric/Vinyl Grade 5	FG5/VG5	+ \$360
Fabric/Vinyl Grade 6	FG6/VG6	+ \$510
Fabric/Vinyl Grade 7	FG7/VG7	+ \$660
Leather Grade 1	LG1	+ \$945
COL	COL	+ \$1,197
Leather Grade 2	LG2	+ \$1,197
Leather Grade 3	LG3	+ \$1,512

3. Material (Cont.)

Multi-Upholstery	Code	Price
Multi-Upholstery Upcharge	UMU	+ \$75
Midback Textile		Seat Only Back and Arms
Fabric/Vinyl Grade 1	FG1/VG1	+ \$0 + \$0
COM	COM	+ \$15 + \$38
Fabric/Vinyl Grade 2	FG2/VG2	+ \$15 + \$38
Fabric/Vinyl Grade 3	FG3/VG3	+ \$40 + \$104
Fabric/Vinyl Grade 4	FG4/VG4	+ \$70 + \$182
Fabric/Vinyl Grade 5	FG5/VG5	+ \$120 + \$312
Fabric/Vinyl Grade 6	FG6/VG6	+ \$170 + \$443
Fabric/Vinyl Grade 7	FG7/VG7	+ \$220 + \$573
Leather Grade 1	LG1	+ \$315 + \$828
COL	COL	+ \$399 + \$1,049
Leather Grade 2	LG2	+ \$399 + \$1,049
Leather Grade 3	LG3	+ \$504 + \$1,326
Highback (For BH5) Textile		Seat Only Back and Arms
Fabric/Vinyl Grade 1	FG1/VG1	+ \$0 + \$0
COM	COM	+ \$15 + \$41
Fabric/Vinyl Grade 2	FG2/VG2	+ \$15 + \$41
Fabric/Vinyl Grade 3	FG3/VG3	+ \$40 + \$109
Fabric/Vinyl Grade 4	FG4/VG4	+ \$70 + \$192
Fabric/Vinyl Grade 5	FG5/VG5	+ \$120 + \$329
Fabric/Vinyl Grade 6	FG6/VG6	+ \$170 + \$467
Fabric/Vinyl Grade 7	FG7/VG7	+ \$220 + \$604
Leather Grade 1	LG1	+ \$315 + \$866
COL	COL	+ \$399 + \$1,097
Leather Grade 2	LG2	+ \$399 + \$1,097
Leather Grade 3	LG3	+ \$504 + \$1,386

If different fabrics are selected for the seat and back/arms, add the multiple upholstery upcharge as well, even if the fabrics are the same grade.

Please reference the *Textile Reference Guide* for pricing on fabric over grade 7 and leather over grade 3. Additional CAL 133 information can be found on page 15.

4. Packaging

Packaging	Code	Price
Partially Assembled in Carton	P3	+ \$0
Assembled in Carton	P1	+ \$80



Midback
With Metal Base

EFFECTIVE OCTOBER 17, 2022 | GSA SIN #: 33721

SPECIFICATIONS

Model:	ENV BH4 Midback Lounge	ENV BH5 Highback Lounge
Dimensions		
Height	34.75"	41.5"
Width	27"	27"
Depth	26"	26"
Seat Depth	18"	18"
Seat Height	16.5"	16.5"
Back Height	21.25"	28"
Materials		
COM (Fully Upholstered)	3 yd	3.25 yd
COM (Multi-Upholstery)		
Back and Arms Only	2.5 yd	2.75 yd
Seat Cushion Only	1 yd	1 yd
COL (Fully Upholstered)	50 sq ft	55 sq ft
COL (Multi-Upholstery)		
Back and Arms Only	40 sq ft	45 sq ft
Seat Cushion Only	15 sq ft	15 sq ft
Weight and Capacity		
Weight	42 lb (BMM) 55.5 lb (BMW)	54 lb (BMM) 67.5 lb (BMW)
Weight Capacity Warranty	300 lb	300 lb

Metal base (BMM). Wood base (BMW).



Highback With Metal Base

Gobi

LOUNGE SEATING

Huddle with inspiration.

Work mode. Wait mode. Let's-get-it-done mode. Today's open and collaborative spaces should help you shift spontaneously. And Gobi is the perfect huddle partner. Its sculpted comfort and modern, easygoing design can carry you through the many modes you find yourself in—so that another day at the office feels like anything but.



Charcoal Metal Base

EFFECTIVE OCTOBER 17, 2022

Featured Models

CHARCOAL METAL BASE :: \$1,865

Midback, charcoal metal base, free-swivel fixed-height cylinder, fully upholstered, grade 1 textile

POLISHED ALUMINUM BASE :: \$2,213

Midback, polished aluminum metal base, auto-return fixed-height cylinder, fully upholstered, grade 4 textile

WOOD BASE :: \$2,475

Midback, wood base, free-swivel fixed-height cylinder, fully upholstered, grade 4 textile

Features

- Minimalist design with crisp lines and tailored stitching
- Flared arms allow room for bags, laptops and more
- Soft, sculpted curves provide extra comfort
- Multi-upholstery options on seat cushion
- Bases available in three metal and wood finishes
- Auto-return cylinder available on metal base only
- 300 lb weight capacity warranty

1. Product

Back Size and Style	Code	Price	
Midback Lounge	GBI BH4	\$1,865	

2. Base

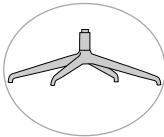
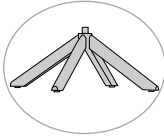
Cylinder	Code	Price	
Free Swivel, Fixed Height	CH5	+ \$0	
Auto-Return, Fixed Height	CH6	+ \$25	
Base Material	Code	Price	
Metal	BMM	+ \$0	
Wood	BMW	+ \$400	

Auto-return cylinder (CH6) is only available with metal base (BMM).

LOUNGE SEATING

2. Base (Cont.)

Base Color	Code	Price	
Metal Color			
Charcoal	BF04	+ \$0	
Bronze	BF05	+ \$0	
Polished Aluminum	BF07	+ \$113	
Wood Cap Stain			
Uptown	BF08	+ \$0	
Colombian	BF09	+ \$0	
Skyline	BF10	+ \$0	
Glides	Code	Price	
Standard Multi-Surface Glides	GL1	+ \$0	

3. Material

Protection	Code	Price	
Fire Retardancy			
CAL 133	UCAL	+\$262	
Cleaning	Code	Price	
Moisture Barrier			
Seat Only	UM2	+\$59	
Back Only	UM1	+\$59	
Seat and Back	UM3	+\$118	
Fully Upholstered	Code	Price	
Fabric/Vinyl Grade 1	FG1/VG1	+ \$0	
COM	COM	+ \$45	
Fabric/Vinyl Grade 2	FG2/VG2	+ \$45	
Fabric/Vinyl Grade 3	FG3/VG3	+ \$120	
Fabric/Vinyl Grade 4	FG4/VG4	+ \$210	
Fabric/Vinyl Grade 5	FG5/VG5	+ \$360	
Fabric/Vinyl Grade 6	FG6/VG6	+ \$510	
Fabric/Vinyl Grade 7	FG7/VG7	+ \$660	
Leather Grade 1	LG1	+ \$1,181	
COL	COL	+ \$1,496	
Leather Grade 2	LG2	+ \$1,496	
Leather Grade 3	LG3	+ \$1,890	

3. Material (Cont.)

Multi-Upholstery	Code	Price
Multi-Upholstery Upcharge	UMU	+ \$75
Seat Shell Textile Only		
Fabric/Vinyl Grade 1	FG1/VG1	+ \$0
COM	COM	+ \$30
Fabric/Vinyl Grade 2	FG2/VG2	+ \$30
Fabric/Vinyl Grade 3	FG3/VG3	+ \$80
Fabric/Vinyl Grade 4	FG4/VG4	+ \$140
Fabric/Vinyl Grade 5	FG5/VG5	+ \$240
Fabric/Vinyl Grade 6	FG6/VG6	+ \$340
Fabric/Vinyl Grade 7	FG7/VG7	+ \$440
Leather Grade 1	LG1	+ \$788
COL	COL	+ \$998
Leather Grade 2	LG2	+ \$998
Leather Grade 3	LG3	+ \$1,260
Multi-Upholstery	Code	Price
Seat Cushion Textile Only		
Fabric/Vinyl Grade 1	FG1/VG1	+ \$0
COM	COM	+ \$15
Fabric/Vinyl Grade 2	FG2/VG2	+ \$15
Fabric/Vinyl Grade 3	FG3/VG3	+ \$40
Fabric/Vinyl Grade 4	FG4/VG4	+ \$70
Fabric/Vinyl Grade 5	FG5/VG5	+ \$120
Fabric/Vinyl Grade 6	FG6/VG6	+ \$170
Fabric/Vinyl Grade 7	FG7/VG7	+ \$220
Leather Grade 1	LG1	+ \$394
COL	COL	+ \$499
Leather Grade 2	LG2	+ \$499
Leather Grade 3	LG3	+ \$630

Textiles approved for Nano and Paseo apply to Gobi. Refer to textile compatibility tool for up-to-date offerings.

If different fabrics are selected for the seat cushion and shell, add the multiple upholstery upcharge as well, even if the fabrics are the same grade.

Please reference the Textile Reference Guide for pricing on fabric over grade 7 and leather over grade 3. Additional CAL 133 information can be found on page 15.

4. Packaging

Packaging	Code	Price
Partially Assembled in Carton	P3	+ \$0
Assembled in Carton	P1	+ \$80

LOUNGE SEATING

SPECIFICATIONS

Model:	GBI BH4 Midback Lounge
Dimensions	
Height	31.5"
Width	30.25"
Depth	31"
Seat Depth	19"
Seat Height	17.25"
Back Height	21.5"
Materials	
COM (Fully Upholstered)	3.5 yd
COM (Multi-Upholstery) Seat Shell Only Seat Cushion Only	2.8 yd 1 yd
COL (Single Upholstery)	55 sq ft
COL (Multi-Upholstered) Seat Shell Only Seat Cushion Only	48 sq ft 15 sq ft
Weight and Capacity	
Weight	37.5 lb (BMM) 51 lb (BMW)
Weight Capacity Warranty	300 lb

Metal base (BMM). Wood base (BMW).



Wood Base

Nano

MODULAR LOUNGE TYPICALS

Easy from every angle.

Meet Nano, our uniquely designed and easy-to-spec modular lounge collection. Featuring a triangle, diamond, trapezoid and boomerang, Nano's geometric shapes make on-the-spot configuration easy and fun. Create a new, one-of-a-kind look every time in thousands of combinations.

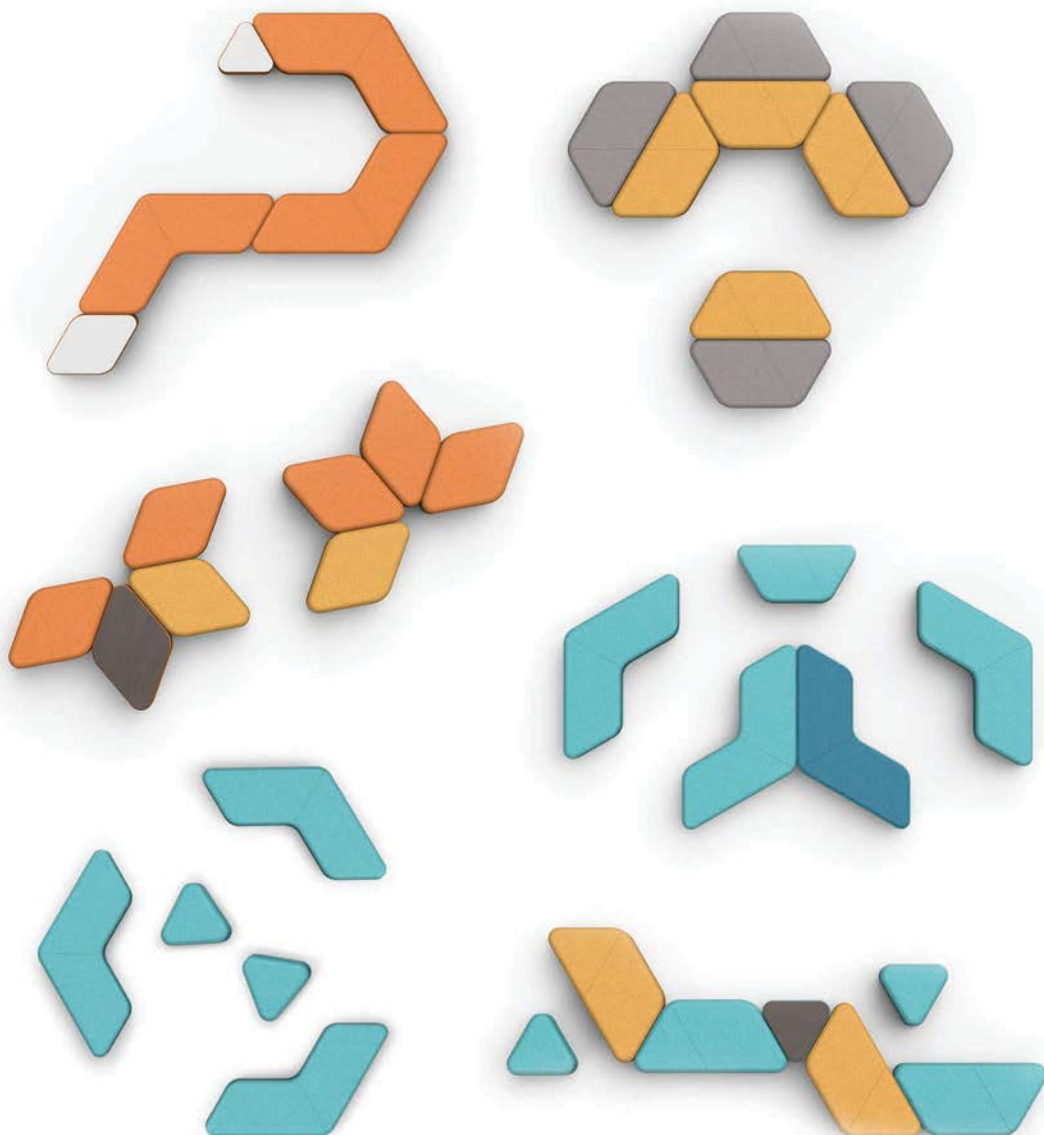

EFFECTIVE OCTOBER 17, 2022 | GSA SIN #: 33721

Typical 1

Line	Category	Part Number	Qty	Description	Unit Price	Ext Price		
1	Table	NNO FS14 TM4 TSS2 FG1 LS1	1	Diamond, Solid Surface Tabletop, Fixed Glides, Fully Upholstered, Grade 1 Textile	\$1,734	\$1,734		
2	Seating	NNO FS16 TM0 FG1 LS1	3	Boomerang, Fixed Glides, Fully Upholstered, Grade 1 Textile	\$3,342	\$10,026		
3	Table	NNO FS13 TM4 TSS2 FG1 LS1	1	Triangle, Solid Surface Tabletop, Fixed Glides, Fully Upholstered, Grade 1 Textile	\$1,220	\$1,220		
TOTAL: \$12,980								

Typical 2

Line	Category	Part Number	Qty	Description	Unit Price	Ext Price		
1	Seating	NNO FS16 TM0 FG1 LS1	4	Boomerang, Fixed Glides, Fully Upholstered, Grade 1 Textile	\$3,342	\$13,368		
2	Seating	NNO FS15 TM0 FG1 LS1	1	Trapezoid, Fixed Glides, Fully Upholstered, Grade 1 Textile	\$1,415	\$1,415		
TOTAL: \$14,783								

Typical 3

Line	Category	Part Number	Qty	Description	Unit Price	Ext. Price		
1	Seating	NNO FS13 TM0 FG1 LS1	2	Triangle, Fixed Glides, Fully Upholstered, Grade 1 Textile	\$580	\$1,160		
2	Table	NNO FS13 TM3 TL15 FG1 LS1	1	Triangle, Laminate Tabletop, Fixed Glides, Fully Upholstered, Grade 1 Textile	\$720	\$720		
3	Seating	NNO FS15 TM0 FG1 LS1	4	Trapezoid, Fixed Glides, Fully Upholstered, Grade 1 Textile	\$1,415	\$5,660		
TOTAL: \$7,540								

Typical 4

Line	Category	Part Number	Qty	Description	Unit Price	Ext. Price		
1	Seating	NNO FS14 TM0 FG1 LS1	7	Diamond, Fixed Glides, Fully Upholstered, Grade 1 Textile	\$838	\$5,866		
2	Table	NNO FS14 TM3 TL15 FG1 LS1	1	Diamond, Laminate Tabletop, Fixed Glides, Fully Upholstered, Grade 1 Textile	\$1,034	\$1,034		
TOTAL: \$6,900								

Typical 5

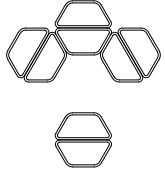
Line	Category	Part Number	Qty	Description	Unit Price	Ext. Price	
1	Seating	NNO FS15 TM0 FG1 LS1	8	Trapezoid, Fixed Glides, Fully Upholstered, Grade 1 Textile	\$1,415	\$11,320	

TOTAL: \$11,320

Typical 6

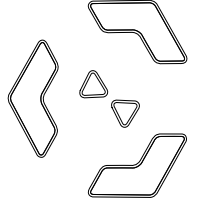
Line	Category	Part Number	Qty	Description	Unit Price	Ext. Price	
1	Seating	NNO FS16 TM0 FG1 LS1	3	Boomerang, Fixed Glides, Fully Upholstered, Grade 1 Textile	\$3,342	\$10,026	
2	Seating	NNO FS13 TM0 FG1 LS1	2	Triangle, Fixed Glides, Fully Upholstered, Grade 1 Textile	\$580	\$1,160	

TOTAL: \$11,186

Typical 7

Line	Category	Part Number	Qty	Description	Unit Price	Ext. Price	
1	Table	NNO FS13 TM3 TL13 FG1 LS1	2	Triangle, Laminate Tabletop, Fixed Glides, Fully Upholstered, Grade 1 Textile	\$720	\$1,440	
2	Seating	NNO FS14 TM0 FG1 LS1	2	Diamond, Fixed Glides, Fully Upholstered, Grade 1 Textile	\$838	\$1,676	
3	Seating	NNO FS15 TM0 FG1 LS1	4	Trapezoid, Fixed Glides, Fully Upholstered, Grade 1 Textile	\$1,415	\$5,660	

TOTAL: \$8,776

Typical 8

Line	Category	Part Number	Qty	Description	Unit Price	Ext. Price	
1	Seating	NNO FS13 TM0 FG1 LS1	2	Triangle, Fixed Glides, Fully Upholstered, Grade 1 Textile	\$580	\$1,160	
2	Seating	NNO FS16 TM0 FG1 LS1	4	Boomerang, Fixed Glides, Fully Upholstered, Grade 1 Textile	\$3,342	\$13,368	
3	Seating	NNO FS15 TM0 FG1 LS1	2	Trapezoid, Fixed Glides, Fully Upholstered, Grade 1 Textile	\$1,415	\$2,830	

TOTAL: \$17,358

EFFECTIVE OCTOBER 17, 2022 | GSA SIN #: 33721

Typical 9

Line	Category	Part Number	Qty	Description	Unit Price	Ext Price	
1	Table	NNO FS13 TM4 TSS2 FG1 LS1	5	Triangle, Solid Surface Tabletop, Fixed Glides, Fully Upholstered, Grade 1 Textile	\$1,220	\$6,100	
2	Seating	NNO FS16 TM0 FG1 LS1	3	Boomerang, Fixed Glides, Fully Upholstered, Grade 1 Textile	\$3,342	\$10,026	
3	Seating	NNO FS15 TM0 FG1 LS1	6	Trapezoid, Fixed Glides, Fully Upholstered, Grade 1 Textile	\$1,415	\$8,490	

TOTAL: \$24,616

Typical 10

Line	Category	Part Number	Qty	Description	Unit Price	Ext Price	
1	Seating	NNO FS15 TM0 FG1 LS1	4	Trapezoid, Fixed Glides, Fully Upholstered, Grade 1 Textile	\$1,415	\$5,660	
2	Table	NNO FS13 TM4 TSS2 FG1 LS1	2	Triangle, Solid Surface Tabletop, Fixed Glides, Fully Upholstered, Grade 1 Textile	\$1,220	\$2,440	
3	Seating	NNO FS14 TM0 FG1 LS1	1	Diamond, Fixed Glides, Fully Upholstered, Grade 1 Textile	\$838	\$838	
4	Table	NNO FS14 TM4 TSS2 FG1 LS1	1	Diamond, Solid Surface Tabletop, Fixed Glides, Fully Upholstered, Grade 1 Textile	\$1,734	\$1,734	

TOTAL: \$10,672

Typical 11

Line	Category	Part Number	Qty	Description	Unit Price	Ext Price	
1	Table	NNO FS13 TM3 TL14 FG1 LS1	2	Triangle, Laminate Tabletop, Fixed Glides, Fully Upholstered, Grade 1 Textile	\$720	\$1,440	
2	Seating	NNO FS15 TM0 FG1 LS1	4	Trapezoid, Fixed Glides, Fully Upholstered, Grade 1 Textile	\$1,415	\$5,660	
3	Seating	NNO FS14 TM0 FG1 LS1	1	Diamond, Fixed Glides, Fully Upholstered, Grade 1 Textile	\$838	\$838	
4	Table	NNO FS14 TM3 TL14 FG1 LS1	1	Diamond, Laminate Tabletop, Fixed Glides, Fully Upholstered, Grade 1 Textile	\$1,034	\$1,034	

TOTAL: \$8,972

EFFECTIVE OCTOBER 17, 2022 | GSA SIN #: 33721

Typical 12

Line	Category	Part Number	Qty	Description	Unit Price	Ext. Price	
1	Seating	NNO FS15 TM0 FG1 LS1	4	Trapezoid, Fixed Glides, Fully Upholstered, Grade 1 Textile	\$1,415	\$5,660	
2	Table	NNO FS13 TM4 TSS2 FG1 LS1	1	Triangle, Solid Surface Tabletop, Fixed Glides, Fully Upholstered, Grade 1 Textile	\$1,220	\$1,220	
3	Seating	NNO FS14 TM0 FG1 LS1	1	Diamond, Fixed Glides, Fully Upholstered, Grade 1 Textile	\$838	\$838	
4	Table	NNO FS14 TM4 TSS2 FG1 LS1	1	Diamond, Solid Surface Tabletop, Fixed Glides, Fully Upholstered, Grade 1 Textile	\$1,734	\$1,734	
5	Seating	NNO FS13 TM0 FG1 LS1	1	Triangle, Fixed Glides, Fully Upholstered, Grade 1 Textile	\$580	\$580	

TOTAL: \$10,032

Typical 13

Line	Category	Part Number	Qty	Description	Unit Price	Ext. Price	
1	Seating	NNO FS16 TM0 FG1 LS1	2	Boomerang, Fixed Glides, Fully Upholstered, Grade 1 Textile	\$3,342	\$6,684	
2	Seating	NNO FS15 TM0 FG1 LS1	2	Trapezoid, Fixed Glides, Fully Upholstered, Grade 1 Textile	\$1,415	\$2,830	

TOTAL: \$9,514

Typical 14

Line	Category	Part Number	Qty	Description	Unit Price	Ext. Price	
1	Seating	NNO FS15 TM0 FG1 LS1	4	Trapezoid, Fixed Glides, Fully Upholstered, Grade 1 Textile	\$1,415	\$5,660	
2	Seating	NNO FS14 TM0 FG1 LS1	1	Diamond, Fixed Glides, Fully Upholstered, Grade 1 Textile	\$838	\$838	
3	Table	NNO FS14 TM3 TL13 FG1 LS1	1	Diamond, Laminate Tabletop, Fixed Glides, Fully Upholstered, Grade 1 Textile	\$1,034	\$1,034	
4	Table	NNO FS13 TM3 TL13 FG1 LS1	1	Triangle, Laminate Tabletop, Fixed Glides, Fully Upholstered, Grade 1 Textile	\$720	\$720	
5	Seating	NNO FS13 TM0 FG1 LS1	1	Triangle, Fixed Glides, Fully Upholstered, Grade 1 Textile	\$580	\$580	

TOTAL: \$8,832

EFFECTIVE OCTOBER 17, 2022 | GSA SIN #: 33721

Typical 15

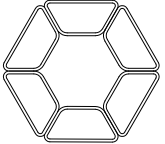
Line	Category	Part Number	Qty	Description	Unit Price	Ext. Price	
1	Seating	NNO FS15 TM0 FG1 LS1	6	Trapezoid, Fixed Glides, Fully Upholstered, Grade 1 Textile	\$1,415	\$8,490	
						TOTAL: \$8,490	

Typical 16

Line	Category	Part Number	Qty	Description	Unit Price	Ext. Price	
1	Seating	NNO FS15 TM0 FG1 LS1	4	Trapezoid, Fixed Glides, Fully Upholstered, Grade 1 Textile	\$1,415	\$5,660	
2	Seating	NNO FS14 TM0 FG1 LS1	1	Diamond, Fixed Glides, Fully Upholstered, Grade 1 Textile	\$838	\$838	
3	Table	NNO FS14 TM3 TL15 FG1 LS1	1	Diamond, Laminate Tabletop, Fixed Glides, Fully Upholstered, Grade 1 Textile	\$1,034	\$1,034	
4	Seating	NNO FS13 TM0 FG1 LS1	2	Trangle, Fixed Glides, Fully Upholstered, Grade 1 Textile	\$580	\$1,160	
						TOTAL: \$8,692	

Nano

MODULAR LOUNGE

Easy from every angle.

Meet Nano, our uniquely designed and easy-to-spec modular lounge collection. Featuring a triangle, diamond, trapezoid and boomerang, Nano's geometric shapes make on-the-spot configuration easy and fun. Create a new, one-of-a-kind look every time in thousands of combinations.



Boomerang

EFFECTIVE OCTOBER 17, 2022

Featured Models

TRIANGLE TABLE :: \$777

Triangle with laminate tabletop, grade 3 textiles

TRAPEZOID :: \$1,632

Trapezoid, multi-upholstery, grade 3 textiles

BOOMERANG :: \$3,637

Boomerang, multi-upholstery, grade 2 chassis, grade 4 seat

Features

- Four shapes for endless configuration possibilities
- Effortless and fun to design
- Reconfigurable on-the-spot to adapt to any space
- Triangle and diamond shapes feature two solid surface and five laminate tabletop options to enhance functionality
- Mobile and easy to move, or make permanent with ganging brackets
- 400 lb weight capacity warranty (per seat position)



Triangle Table



Trapezoid

MODULAR LOUNGE

1. Product

Model	Code	Price	
Triangle	NNO FS13	\$580	
Diamond	NNO FS14	\$838	
Trapezoid	NNO FS15	\$1,415	
Boomerang	NNO FS16	\$3,342	

2. Tabletop

Tabletop Material	Code	Price	
		Triangle	Diamond
No Tabletop	TM0	+ \$0	+ \$0
Laminate	TM3	+ \$140	+ \$196
Solid Surface	TM4	+ \$640	+ \$896
Tabletop Finish		Price	
Laminate Finish			
Field Elm	TL13	+ \$0	
Uptown Walnut	TL14	+ \$0	
Skyline Walnut	TL15	+ \$0	
Frosty White	TL16	+ \$0	
Classic Linen	TL17	+ \$0	
Solid Surface Color			
Designer White	TSS2	+ \$0	
Cameo White	TSS1	+ \$0	

Tabletops available on triangle and diamond models only.

3. Material

Protection		Code		Price			
Fire Retardancy		Triangle	Triangle Table	Diamond	Diamond Table	Trapezoid	Boomerang
CAL 133	UCAL	+ \$88	+ \$88	+ \$175	+ \$175	+ \$262	+ \$494
Cleaning		Code		Price			
Moisture Barrier		Triangle	Triangle Table	Diamond	Diamond Table	Trapezoid	Boomerang
Seat	UM2	+ \$35	N/A	+ \$59	N/A	+ \$118	+ \$177
Fully Upholstered		Code		Price			
Seat and Chassis		Triangle	Triangle Table	Diamond	Diamond Table	Trapezoid	Boomerang
Fabric/Vinyl Grade 1	FG1/VG1	+ \$0	+ \$0	+ \$0	+ \$0	+ \$0	+ \$0
COM	COM	+ \$40	+ \$36	+ \$61	+ \$40	+ \$77	+ \$135
Fabric/Vinyl Grade 2	FG2/VG2	+ \$40	+ \$36	+ \$61	+ \$40	+ \$77	+ \$135
Fabric/Vinyl Grade 3	FG3/VG3	+ \$63	+ \$57	+ \$94	+ \$63	+ \$120	+ \$210
Fabric/Vinyl Grade 4	FG4/VG4	+ \$90	+ \$81	+ \$135	+ \$90	+ \$171	+ \$300
Fabric/Vinyl Grade 5	FG5/VG5	+ \$135	+ \$121	+ \$202	+ \$135	+ \$256	+ \$450
Fabric/Vinyl Grade 6	FG6/VG6	+ \$180	+ \$162	+ \$270	+ \$180	+ \$342	+ \$600
Fabric/Vinyl Grade 7	FG7/VG7	+ \$225	+ \$202	+ \$337	+ \$225	+ \$427	+ \$750
Multi-Upholstery		Code		Price			
Multi-Upholstery Upcharge		Triangle	Triangle Table	Diamond	Diamond Table	Trapezoid	Boomerang
Multi-Upholstery Upcharge	UMU	+ \$75	N/A	+ \$75	N/A	+ \$75	+ \$75
Seat Only		Triangle	Triangle Table	Diamond	Diamond Table	Trapezoid	Boomerang
Fabric/Vinyl Grade 1	FG1/VG1	+ \$0	N/A	+ \$0	N/A	+ \$0	+ \$0
COM	COM	+ \$19	N/A	+ \$34	N/A	+ \$31	+ \$61
Fabric/Vinyl Grade 2	FG2/VG2	+ \$19	N/A	+ \$34	N/A	+ \$31	+ \$61
Fabric/Vinyl Grade 3	FG3/VG3	+ \$29	N/A	+ \$52	N/A	+ \$48	+ \$94
Fabric/Vinyl Grade 4	FG4/VG4	+ \$42	N/A	+ \$75	N/A	+ \$69	+ \$135
Fabric/Vinyl Grade 5	FG5/VG5	+ \$63	N/A	+ \$112	N/A	+ \$103	+ \$202
Fabric/Vinyl Grade 6	FG6/VG6	+ \$84	N/A	+ \$150	N/A	+ \$138	+ \$270
Fabric/Vinyl Grade 7	FG7/VG7	+ \$105	N/A	+ \$187	N/A	+ \$172	+ \$337
Chassis Only		Triangle	Triangle Table	Diamond	Diamond Table	Trapezoid	Boomerang
Fabric/Vinyl Grade 1	FG1/VG1	+ \$0	N/A	+ \$0	N/A	+ \$0	+ \$0
COM	COM	+ \$36	N/A	+ \$40	N/A	+ \$61	+ \$85
Fabric/Vinyl Grade 2	FG2/VG2	+ \$36	N/A	+ \$40	N/A	+ \$61	+ \$85
Fabric/Vinyl Grade 3	FG3/VG3	+ \$57	N/A	+ \$63	N/A	+ \$94	+ \$132
Fabric/Vinyl Grade 4	FG4/VG4	+ \$81	N/A	+ \$90	N/A	+ \$135	+ \$189
Fabric/Vinyl Grade 5	FG5/VG5	+ \$121	N/A	+ \$135	N/A	+ \$202	+ \$283
Fabric/Vinyl Grade 6	FG6/VG6	+ \$162	N/A	+ \$180	N/A	+ \$270	+ \$378
Fabric/Vinyl Grade 7	FG6/VG7	+ \$202	N/A	+ \$225	N/A	+ \$337	+ \$472

Moisture barrier (UM2) seat is not available with tabletop (TM3/TM4). If different fabrics are selected for the seat and chassis, add the multiple upholstery upcharge as well. Please reference the Textile Reference Guide for pricing on fabric over grade 7 and leather over grade 3. Additional CAL 133 information can be found on page 15.

EFFECTIVE OCTOBER 17, 2022 | GSA SIN #: 33721

4. Glides

Glide Options	Code	Price
Fixed Glides	LS1	+ \$0

5. Options

Accessories	Code	Price
One Ganging Bracket (Attaches to Either Side)	XGV	+ \$52

Trapezoid and boomerang accommodate up to two ganging units on the 52" sides.

6. Packaging

Packaging	Code	Price
Fully Assembled in a Carton	P1	+ \$0

SPECIFICATIONS

Model:	NNO FS13 Triangle	NNO FS14 Diamond	NNO FS15 Trapezoid	NNO FS16 Boomerang
Dimensions				
Height (TM0)	17"	17"	17"	17"
Height (TM3/TM4)	17"	17"	—	—
Width	23"	37.5"	52"	81"
Depth	21"	25"	25"	50"
Weight	21 lb	32 lb	45 lb	92 lb
Materials				
COM (Fully Upholstered)	2 yd	3 yd	3.5 yd	6.5 yd
COM (Multi-Upholstery)				
Seat Only	1 yd	1.5 yd	1.5 yd	3 yd
Chassis Only	2 yd	2 yd	3 yd	4 yd
Weight and Capacity				
Weight (TM3)	31.5 lb	54.5 lb	—	—
Weight (TM4)	30 lb	51.1 lb	—	—
Weight Capacity Warranty	400 lb	400 lb	800 lb	1200 lb

No tabletop (TM0). Solid surface tabletop (TM4). Laminate tabletop (TM3).

Yardage requirements for COM are for solid and non-directional fabrics. Additional material may be required for larger repeating patterns.

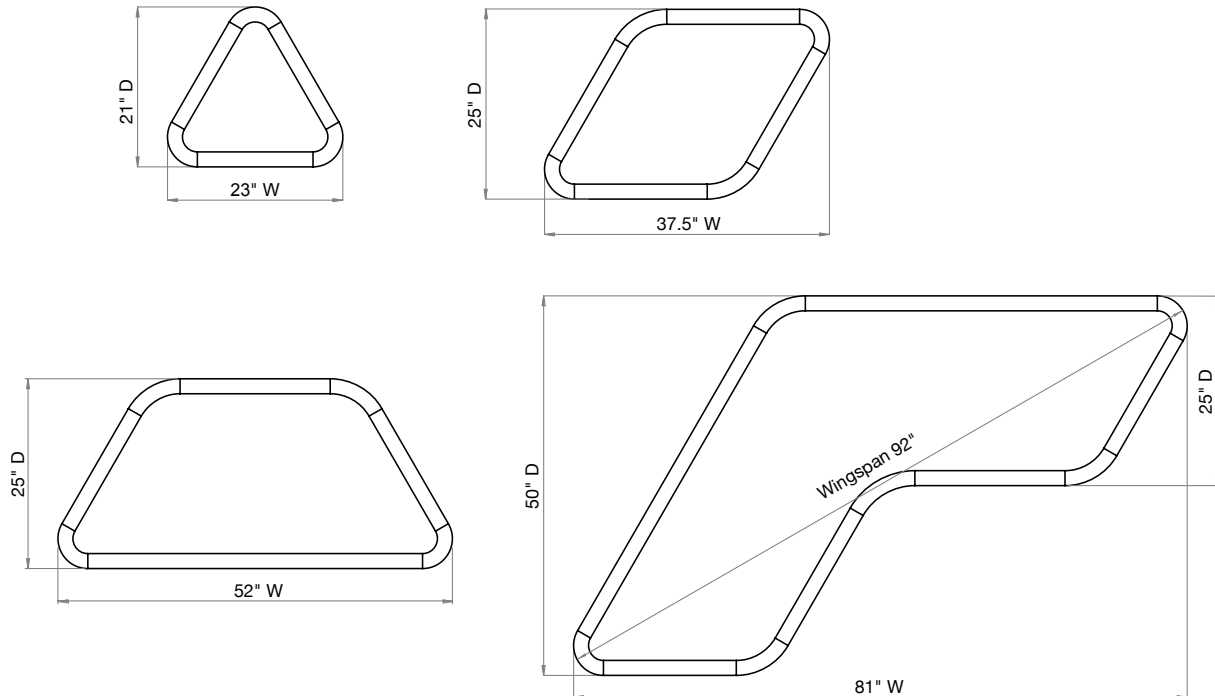

Paséa

MODULAR LOUNGE TYPICALS

Lounge that works.

Paséa features tapered angles and comfort scaling for a lightweight, refined style while promoting an active working posture so that you get our award-winning task chair performance away from your desk.

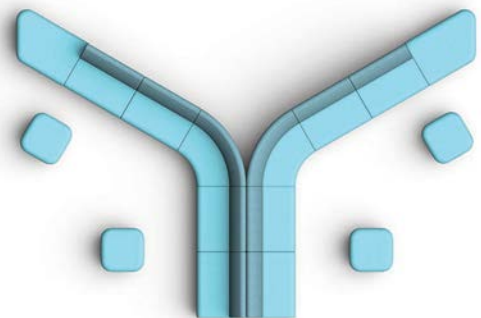
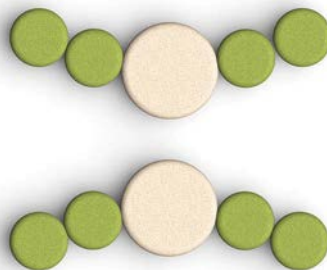
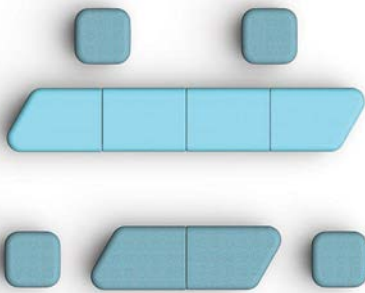
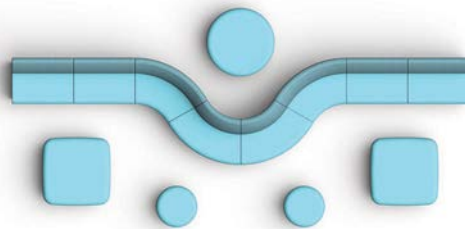
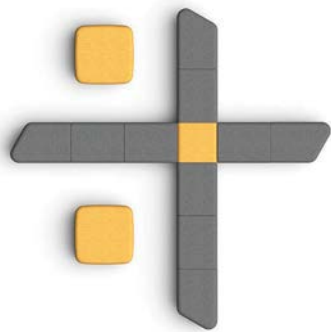

EFFECTIVE OCTOBER 17, 2022

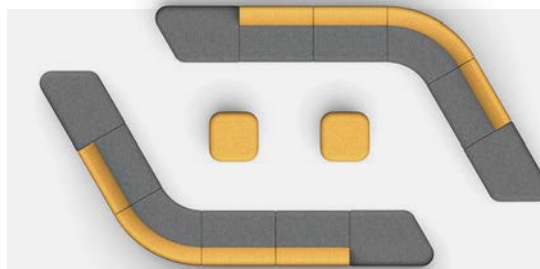
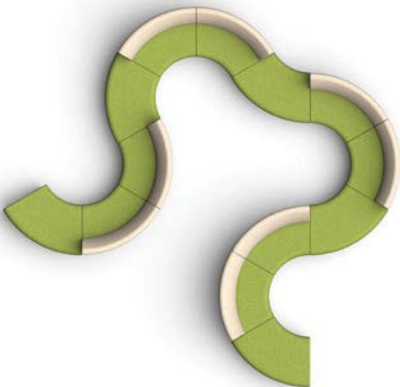

EFFECTIVE OCTOBER 17, 2022 | GSA SIN #: 33721

Typical 1

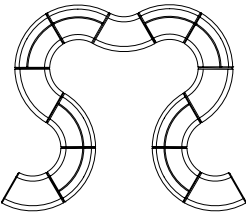
Line	Category	Part Number	Qty	Description	Unit Price	Ext Price	
1	Seating	PAS FS17 SS3	8	120-Degree Inner Seat, Fully Upholstered, Grade 1 Textile	\$3,071	\$24,568	
2	Seating	PAS FS2 BNS6	5	120° Bench, Fully Upholstered, Grade 1 Textile	\$2,303	\$11,515	

TOTAL: \$36,083

Typical 2

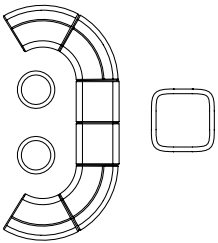
Line	Category	Part Number	Qty	Description	Unit Price	Ext Price	
1	Seating	PAS FS17 SS3	4	120-Degree Inner Seat, Fully Upholstered, Grade 1 Textile	\$3,071	\$12,284	
2	Seating	PAS FS2 BNS1	2	Single Bench, Fully Upholstered, Grade 1 Textile	\$1,281	\$2,562	
3	Seating	PAS FS1 OS1	2	Mini Round Ottoman, Fully Upholstered, Grade 1 Textile	\$769	\$1,538	
4	Seating	PAS FS1 OS4	1	Large Square Ottoman, Fully Upholstered, Grade 1 Textile	\$1,472	\$1,472	

TOTAL: \$17,856

Typical 3

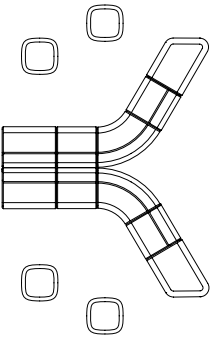
Line	Category	Part Number	Qty	Description	Unit Price	Ext Price	
1	Seating	PAS FS17 SS2	2	1.5 Seat, Fully Upholstered, Grade 1 Textile	\$2,047	\$4,094	
2	Seating	PAS FS17 SS1	4	Single Seat, Fully Upholstered, Grade 1 Textile	\$1,665	\$6,660	
3	Seating	PAS FS17 SS3	2	120° Inner Seat, Fully Upholstered, Grade 1 Textile	\$3,071	\$6,142	
4	Seating	PAS FS2 BNS3	1	Right-Angled End Bench, Fully Upholstered, Grade 1 Textile	\$1,590	\$1,590	
5	Seating	PAS FS2 BNS4	1	Left-Angled End Bench, Fully Upholstered, Grade 1 Textile	\$1,590	\$1,590	
6	Seating	PAS FS1 OS3	4	Mini Square Ottoman, Fully Upholstered, Grade 1 Textile	\$769	\$3,076	

TOTAL: \$23,152

Typical 4

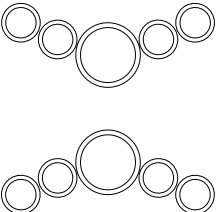
Line	Category	Part Number	Qty	Description	Unit Price	Ext Price	
1	Seating	PAS FS1 OS1	8	Mini Round Ottoman, Fully Upholstered, Grade 1 Textile	\$769	\$6,152	
2	Seating	PAS FS1 OS2	2	Large Round Ottoman, Fully Upholstered, Grade 1 Textile	\$1,472	\$2,944	

TOTAL: \$9,096

EFFECTIVE OCTOBER 17, 2022 | GSA SIN #: 33721

Typical 5

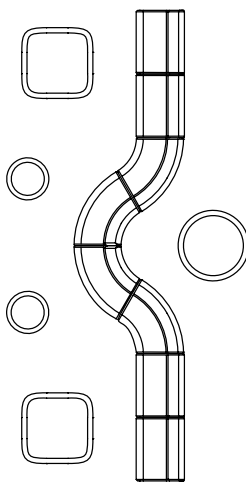
Line	Category	Part Number	Qty	Description	Unit Price	Ext Price	
1	Seating	PAS FS1 OS1	2	Mini Round Ottoman, Fully Upholstered, Grade 1 Textile	\$769	\$1,538	
2	Seating	PAS FS1 OS4	2	Large Square Ottoman, Fully Upholstered, Grade 1 Textile	\$1,472	\$2,944	
3	Seating	PAS FS17 SS4	2	120-Degree Outer Seat, Fully Upholstered, Grade 1 Textile	\$3,071	\$6,142	
4	Seating	PAS FS17 SS3	2	120-Degree Inner Seat, Fully Upholstered, Grade 1 Textile	\$3,071	\$6,142	
5	Seating	PAS FS17 SS2	4	1.5 Seat, Fully Upholstered, Grade 1 Textile	\$2,047	\$8,188	
6	Seating	PAS FS1 OS2	1	Large Round Ottoman, Fully Upholstered, Grade 1 Textile	\$1,472	\$1,472	

TOTAL: \$26,426

Typical 6

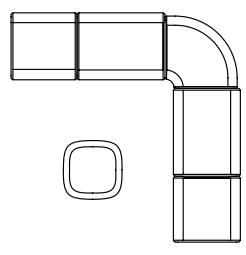
Line	Category	Part Number	Qty	Description	Unit Price	Ext Price	
1	Seating	PAS FS2 BNS1	2	Single Bench, Fully Upholstered, Grade 1 Textile	\$1,281	\$2,562	
2	Seating	PAS FS2 BNS2	2	1.5 Bench, Fully Upholstered, Grade 1 Textile	\$1,665	\$3,330	
3	Seating	PAS FS2 BNS5	1	90-Degree Corner Bench, Fully Upholstered, Grade 1 Textile	\$2,303	\$2,303	
4	Seating	PAS FS1 OS3	1	Mini Square Ottoman, Fully Upholstered, Grade 1 Textile	\$769	\$769	

TOTAL: \$8,964

Typical 7

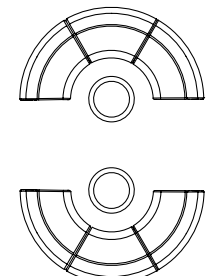
Line	Category	Part Number	Qty	Description	Unit Price	Ext Price	
1	Seating	PAS FS17 SS3	6	120-Degree Inner Seat, Fully Upholstered, Grade 1 Textile	\$3,071	\$18,426	
2	Seating	PAS FS1 OS1	2	Mini Round Ottoman, Fully Upholstered, Grade 1 Textile	\$769	\$1,538	

TOTAL: \$19,964

EFFECTIVE OCTOBER 17, 2022 | GSA SIN #: 33721

Typical 8

Line	Category	Part Number	Qty	Description	Unit Price	Ext Price
1	Seating	PAS FS2 BNS2	4	1.5 Bench, Fully Upholstered, Grade 1 Textile	\$1,665	\$6,660
2	Seating	PAS FS17 SS3	6	120-Degree Inner Seat, Fully Upholstered, Grade 1 Textile	\$3,071	\$18,426
3	Seating	PAS FS1 OS1	2	Mini Round Ottoman, Fully Upholstered, Grade 1 Textile	\$769	\$1,538

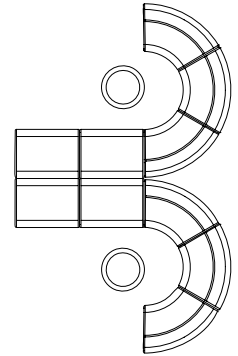

TOTAL: \$26,624

Typical 9

Line	Category	Part Number	Qty	Description	Unit Price	Ext Price
1	Seating	PAS FS17 SS3	4	120-Degree Inner Seat, Fully Upholstered, Grade 1 Textile	\$3,071	\$12,284
2	Seating	PAS FS2 BNS6	2	120-Degree Bench, Fully Upholstered, Grade 1 Textile	\$2,303	\$4,606
3	Seating	PAS FS1 OS1	2	Mini Round Ottoman, Fully Upholstered, Grade 1 Textile	\$769	\$1,538

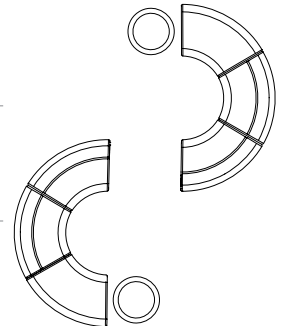

TOTAL: \$18,428

Typical 10

Line	Category	Part Number	Qty	Description	Unit Price	Ext Price
1	Seating	PAS FS17 SS2	8	1.5 Seat, Fully Upholstered, Grade 1 Textile	\$2,047	\$16,376
2	Seating	PAS FS2 BNS5	2	90-Degree Corner Bench, Fully Upholstered, Grade 1 Textile	\$2,303	\$4,606
3	Seating	PAS FS1 OS4	2	Large Square Ottoman, Fully Upholstered, Grade 1 Textile	\$1,472	\$2,944

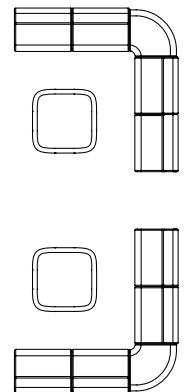

TOTAL: \$23,926

EFFECTIVE OCTOBER 17, 2022 | GSA SIN #: 33721

Typical 11

Line	Category	Part Number	Qty	Description	Unit Price	Ext. Price	
1	Seating	PAS FS1 OS1	3	Mini Round Ottoman, Fully Upholstered, Grade 1 Textile	\$769	\$2,307	
2	Seating	PAS FS2 BNS6	5	120-Degree Bench, Fully Upholstered, Grade 1 Textile	\$2,303	\$11,515	
3	Seating	PAS FS1 OS3	2	Mini Square Ottoman, Fully Upholstered, Grade 1 Textile	\$769	\$1,538	
						TOTAL: \$15,360	

Typical 12

Line	Category	Part Number	Qty	Description	Unit Price	Ext. Price	
1	Seating	PAS FS1 OS3	4	Mini Square Ottoman, Fully Upholstered, Grade 1 Textile	\$769	\$3,076	
2	Seating	PAS FS2 BNS4	4	Left-Angled End Bench, Fully Upholstered, Grade 1 Textile	\$1,590	\$6,360	
3	Seating	PAS FS2 BNS2	2	1.5 Bench, Fully Upholstered, Grade 1 Textile	\$1,665	\$3,330	
						TOTAL: \$12,766	

Typical 13

Line	Category	Part Number	Qty	Description	Unit Price	Ext. Price	
1	Seating	PAS FS1 OS1	3	Mini Round Ottoman, Fully Upholstered, Grade 1 Textile	\$769	\$2,307	
2	Seating	PAS FS17 SS4	3	120-Degree Outer Seat, Fully Upholstered, Grade 1 Textile	\$3,071	\$9,213	
						TOTAL: \$11,520	

Paséa

MODULAR LOUNGE SEATING

Lounge that works.

Work, wait, welcome or wind down, experience the freedom to do anything in a single solution. The tapered base, comfort-scaled seat and built-in backrest with lumbar curve promote an active working posture and lasting support. Rethink what a lounge collection can (and should) be with Paséa.



Single Seat

EFFECTIVE OCTOBER 17, 2022

Featured Models

SINGLE BENCH :: \$1,348

Single seat bench, fully upholstered, grade 3 seat textile

SINGLE SEAT :: \$1,859

Single seat, multi-upholstery, grade 3 seat and back textile

120° SEAT :: \$3,398

120° inner seat, multi-upholstery, grade 4 seat and back textile

MODULAR LOUNGE SEATING

Features



- Choose from a wide variety of benches and seats
- Build using right- or left-angled, 90- or 120-degree pieces
- Configure rectilinear and curvilinear setups with modular seats and benches
- Promote an active working posture with built-in lumbar curve and comfort-scaled seat
- Blend with any environment using graphite or slate base colors

- Add brilliant diamond-cut details with multi-upholstery
- Provide extra convenience with power options
- Adjustable glides standard on modular lounge models
- 400 lb weight capacity warranty (per seat)

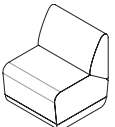
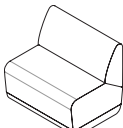
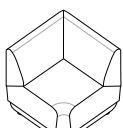
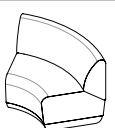
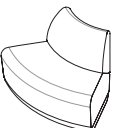
1. Product

Model	Code	Price	
Seat			
Single Seat	PAS FS17 SS1	\$1,665	
1.5 Seat	PAS FS17 SS2	\$2,047	
90-Degree Corner Seat	PAS FS17 SS5	\$2,534	
120-Degree Inner Seat	PAS FS17 SS3	\$3,071	
120-Degree Outer Seat	PAS FS17 SS4	\$3,071	

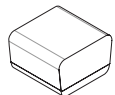
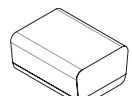
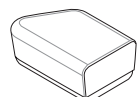
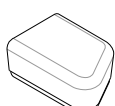
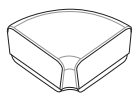
1. Product (Cont.)

Model	Code	Price	
Bench			
Single Bench	PAS FS2 BNS1	\$1,281	
1.5 Bench	PAS FS2 BNS2	\$1,665	
Right-Angled End Bench	PAS FS2 BNS3	\$1,590	
Left-Angled End Bench	PAS FS2 BNS4	\$1,590	
90-Degree Corner Bench	PAS FS2 BNS5	\$2,303	
120-Degree Bench	PAS FS2 BNS6	\$2,303	

2. Base



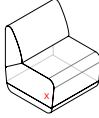
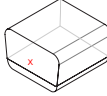
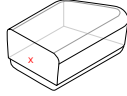
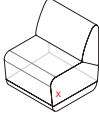
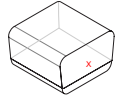
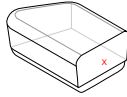
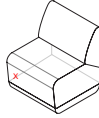
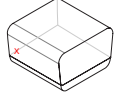
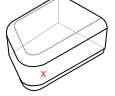

Base Finish	Code	Price
Graphite	LBC2	+ \$0
Slate	LBC3	+ \$0

3. Power



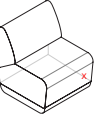
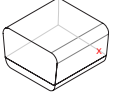
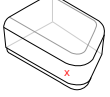
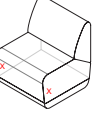

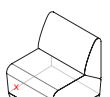
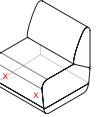
Power Location	Code	Price	
Right-Hand, Side of Unit			
AC/110V	PSR	+ \$125	
Dual USB	PSR	+ \$175	
AC/110V and Dual USB	PSR	+ \$300	
Left-Hand, Side of Unit			
AC/110V	PSL	+ \$125	
Dual USB	PSL	+ \$175	
AC/110V and Dual USB	PSL	+ \$300	
Right-Hand, Front of Unit			
AC/110V	PFR	+ \$125	
Dual USB	PFR	+ \$175	
AC/110V and Dual USB	PFR	+ \$300	

MODULAR LOUNGE SEATING

3. Power (Cont.)

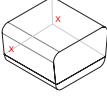
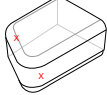
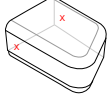
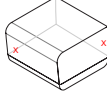

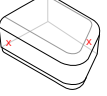
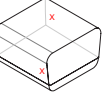

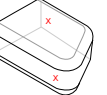
Power Location	Code	Price	
Left-Hand, Front of Unit			
AC/110V	PFL	+ \$125	
Dual USB	PFL	+ \$175	
AC/110V and Dual USB	PFL	+ \$300	
Both Hands, Side of Unit			
AC/110V	PSB	+ \$250	
Dual USB	PSB	+ \$350	
AC/110V and Dual USB	PSB	+ \$600	
Both Hands, Front of Unit			
AC/110V	PFB	+ \$250	
Dual USB	PFB	+ \$350	
AC/110V and Dual USB	PFB	+ \$600	

3. Power (Cont.)

Power Location	Code	Price	
One-Hand, 1 Front and 1 Back			
AC/110V	PBRL	+ \$250	
Dual USB	PBRL	+ \$350	
AC/110V and Dual USB	PBRL	+ \$600	
Both Hands (Right), 1 Front and 1 Back			
AC/110V	PBR	+ \$250	
Dual USB	PBR	+ \$350	
AC/110V and Dual USB	PBR	+ \$600	
Both Hands (Left), 1 Front and 1 Back			
AC/110V	PBL	+ \$250	
Dual USB	PBL	+ \$350	
AC/110V and Dual USB	PBL	+ \$600	

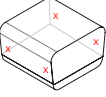
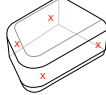
MODULAR LOUNGE SEATING

3. Power (Cont.)

Power Location	Code	Price	
Both Hands, 2 Front and Two Back			
AC/110V	PBB	+ \$500	
Dual USB	PBB	+ \$700	
AC/110V and Dual USB	PBB	+ \$1,200	
Power Type	Code	Price	
AC/110V and Dual USB	PT2	Priced by Number of Units and Location	
Dual USB	PT3	Priced by Number of Units and Location	
AC/110V	PT4	Priced by Number of Units and Location	

Power is storm colored. Power not available on 120-Degree models (FS17 SS3, FS17 SS4, FS2 BNS6) or 90-degree models (FS17 SS5, FS2 BNS5).

4. Material

Protection: CAL 133	Code	Price	
Fire Retardancy			
Single Seat	UCAL	+ \$262	
1.5 Seat	UCAL	+ \$393	
90-Degree Corner Seat	UCAL	+ \$377	
120-Degree Seat	UCAL	+ \$377	
Single Bench	UCAL	+ \$88	
1.5 Bench	UCAL	+ \$175	
Angled Bench	UCAL	+ \$175	
90-Degree Bench	UCAL	+ \$175	
120-Degree Bench	UCAL	+ \$175	

Additional CAL 133 information can be found on page 15.

4. Material (Cont.)

Cleaning	Code	Price	
Moisture Barrier: Seat Only			
Single Seat	UM2	+ \$59	
1.5 Seat	UM2	+ \$89	
90-Degree Corner Seat	UM2	+ \$118	
120-Degree Corner Seat	UM2	+ \$118	
Single Bench	UM2	+ \$59	
1.5 Bench	UM2	+ \$118	
Angled Bench	UM2	+ \$118	
90-Degree Bench	UM2	+ \$177	
120-Degree Bench	UM2	+ \$177	
Moisture Barrier: Back Only			
Single Seat	UM1	+ \$59	
1.5 Seat	UM1	+ \$89	
90-Degree Corner Seat	UM1	+ \$118	
120-Degree Corner Seat	UM1	+ \$118	
Moisture Barrier: Seat and Back			
Single Seat	UM3	+ \$118	
1.5 Seat	UM3	+ \$177	
90-Degree Corner Seat	UM3	+ \$236	
120-Degree Corner Seat	UM3	+ \$236	
Fully Upholstered	Code	Price	
Single Seat			
Fabric/Vinyl Grade 1	FG1/VG1	+ \$0	
COM	COM	+ \$65	
Fabric/Vinyl Grade 2	FG2/VG2	+ \$65	
Fabric/Vinyl Grade 3	FG3/VG3	+ \$101	
Fabric/Vinyl Grade 4	FG4/VG4	+ \$144	
Fabric/Vinyl Grade 5	FG5/VG5	+ \$216	
Fabric/Vinyl Grade 6	FG6/VG6	+ \$288	
Fabric/Vinyl Grade 7	FG7/VG7	+ \$360	

4. Material (Cont.)

Fully Upholstered	Code	Price	
1.5 Seat			
Fabric/Vinyl Grade 1	FG1/VG1	+ \$0	
COM	COM	+ \$86	
Fabric/Vinyl Grade 2	FG2/VG2	+ \$86	
Fabric/Vinyl Grade 3	FG3/VG3	+ \$134	
Fabric/Vinyl Grade 4	FG4/VG4	+ \$192	
Fabric/Vinyl Grade 5	FG5/VG5	+ \$288	
Fabric/Vinyl Grade 6	FG6/VG6	+ \$384	
Fabric/Vinyl Grade 7	FG7/VG7	+ \$480	
90-Degree Corner Seat			
Fabric/Vinyl Grade 1	FG1/VG1	+ \$0	
COM	COM	+ \$113	
Fabric/Vinyl Grade 2	FG2/VG2	+ \$113	
Fabric/Vinyl Grade 3	FG3/VG3	+ \$176	
Fabric/Vinyl Grade 4	FG4/VG4	+ \$252	
Fabric/Vinyl Grade 5	FG5/VG5	+ \$378	
Fabric/Vinyl Grade 6	FG6/VG6	+ \$504	
Fabric/Vinyl Grade 7	FG7/VG7	+ \$630	
120-Degree Seat			
Fabric/Vinyl Grade 1	FG1/VG1	+ \$0	
COM	COM	+ \$94	
Fabric/Vinyl Grade 2	FG2/VG2	+ \$94	
Fabric/Vinyl Grade 3	FG3/VG3	+ \$147	
Fabric/Vinyl Grade 4	FG4/VG4	+ \$210	
Fabric/Vinyl Grade 5	FG5/VG5	+ \$315	
Fabric/Vinyl Grade 6	FG6/VG6	+ \$420	
Fabric/Vinyl Grade 7	FG7/VG7	+ \$525	
Single Seat Bench			
Fabric/Vinyl Grade 1	FG1/VG1	+ \$0	
COM	COM	+ \$43	
Fabric/Vinyl Grade 2	FG2/VG2	+ \$43	
Fabric/Vinyl Grade 3	FG3/VG3	+ \$67	
Fabric/Vinyl Grade 4	FG4/VG4	+ \$96	
Fabric/Vinyl Grade 5	FG5/VG5	+ \$144	
Fabric/Vinyl Grade 6	FG6/VG6	+ \$192	
Fabric/Vinyl Grade 7	FG7/VG7	+ \$240	

4. Material (Cont.)

Fully Upholstered	Code	Price
1.5 Seat Bench		
Fabric/Vinyl Grade 1	FG1/VG1	+ \$0
COM	COM	+ \$54
Fabric/Vinyl Grade 2	FG2/VG2	+ \$54
Fabric/Vinyl Grade 3	FG3/VG3	+ \$84
Fabric/Vinyl Grade 4	FG4/VG4	+ \$120
Fabric/Vinyl Grade 5	FG5/VG5	+ \$180
Fabric/Vinyl Grade 6	FG6/VG6	+ \$240
Fabric/Vinyl Grade 7	FG7/VG7	+ \$300
90-Degree Corner Bench		
Fabric/Vinyl Grade 1	FG1/VG1	+ \$0
COM	COM	+ \$54
Fabric/Vinyl Grade 2	FG2/VG2	+ \$54
Fabric/Vinyl Grade 3	FG3/VG3	+ \$84
Fabric/Vinyl Grade 4	FG4/VG4	+ \$120
Fabric/Vinyl Grade 5	FG5/VG5	+ \$180
Fabric/Vinyl Grade 6	FG6/VG6	+ \$240
Fabric/Vinyl Grade 7	FG7/VG7	+ \$300
120-Degree Seat Bench		
Fabric/Vinyl Grade 1	FG1/VG1	+ \$0
COM	COM	+ \$54
Fabric/Vinyl Grade 2	FG2/VG2	+ \$54
Fabric/Vinyl Grade 3	FG3/VG3	+ \$84
Fabric/Vinyl Grade 4	FG4/VG4	+ \$120
Fabric/Vinyl Grade 5	FG5/VG5	+ \$180
Fabric/Vinyl Grade 6	FG6/VG6	+ \$240
Fabric/Vinyl Grade 7	FG7/VG7	+ \$300
Angled End Bench		
Fabric/Vinyl Grade 1	FG1/VG1	+ \$0
COM	COM	+ \$54
Fabric/Vinyl Grade 2	FG2/VG2	+ \$54
Fabric/Vinyl Grade 3	FG3/VG3	+ \$84
Fabric/Vinyl Grade 4	FG4/VG4	+ \$120
Fabric/Vinyl Grade 5	FG5/VG5	+ \$180
Fabric/Vinyl Grade 6	FG6/VG6	+ \$240
Fabric/Vinyl Grade 7	FG7/VG7	+ \$300

MODULAR LOUNGE SEATING

4. Material (Cont.)

Multi-Upholstery	Code	Price
Multi-Upholstery Upcharge	UMU	+ \$75
Single Seat		Seat Only Back Only
Fabric/Vinyl Grade 1	FG1/VG1	+ \$0 + \$0
COM	COM	+ \$43 + \$34
Fabric/Vinyl Grade 2	FG2/VG2	+ \$43 + \$34
Fabric/Vinyl Grade 3	FG3/VG3	+ \$67 + \$52
Fabric/Vinyl Grade 4	FG4/VG4	+ \$96 + \$75
Fabric/Vinyl Grade 5	FG5/VG5	+ \$144 + \$112
Fabric/Vinyl Grade 6	FG6/VG6	+ \$192 + \$150
Fabric/Vinyl Grade 7	FG7/VG7	+ \$240 + \$187
1.5 Seat		Seat Only Back Only
Fabric/Vinyl Grade 1	FG1/VG1	+ \$0 + \$0
COM	COM	+ \$54 + \$38
Fabric/Vinyl Grade 2	FG2/VG2	+ \$54 + \$38
Fabric/Vinyl Grade 3	FG3/VG3	+ \$84 + \$59
Fabric/Vinyl Grade 4	FG4/VG4	+ \$120 + \$84
Fabric/Vinyl Grade 5	FG5/VG5	+ \$180 + \$126
Fabric/Vinyl Grade 6	FG6/VG6	+ \$240 + \$168
Fabric/Vinyl Grade 7	FG7/VG7	+ \$300 + \$210



120-Degree Inner Seat

4. Material (Cont.)

Multi-Upholstery	Code	Price	
90-Degree Seat		Seat Only	Back Only
Fabric/Vinyl Grade 1	FG1/VG1	+ \$0	+ \$0
COM	COM	+ \$59	+ \$65
Fabric/Vinyl Grade 2	FG2/VG2	+ \$59	+ \$65
Fabric/Vinyl Grade 3	FG3/VG3	+ \$92	+ \$101
Fabric/Vinyl Grade 4	FG4/VG4	+ \$132	+ \$144
Fabric/Vinyl Grade 5	FG5/VG5	+ \$198	+ \$216
Fabric/Vinyl Grade 6	FG6/VG6	+ \$264	+ \$288
Fabric/Vinyl Grade 7	FG7/VG7	+ \$330	+ \$360
120-Degree Seat		Seat Only	Back Only
Fabric/Vinyl Grade 1	FG1/VG1	+ \$0	+ \$0
COM	COM	+ \$59	+ \$54
Fabric/Vinyl Grade 2	FG2/VG2	+ \$59	+ \$54
Fabric/Vinyl Grade 3	FG3/VG3	+ \$92	+ \$84
Fabric/Vinyl Grade 4	FG4/VG4	+ \$132	+ \$120
Fabric/Vinyl Grade 5	FG5/VG5	+ \$198	+ \$180
Fabric/Vinyl Grade 6	FG6/VG6	+ \$264	+ \$240
Fabric/Vinyl Grade 7	FG7/VG7	+ \$330	+ \$300

If different fabrics are selected for the seat and back, add the multiple upholstery upcharge as well, even if the fabrics are the same grade.

Please reference the *Textile Reference Guide* for pricing on fabric over grade 7 and leather over grade 3. Additional CAL 133 information can be found on page 15.

5. Options

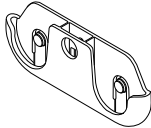
Accessories	Code	Price	
Two Ganging Brackets to Connect to Left-Side or Right-Side	XGV	+ \$52	

One XGV set connects one side of a unit. Order two sets if you need the unit connected on both sides.

6. Packaging

Packaging	Code	Price	
Fully Assembled in Carton	P1	+ \$0	

MODULAR LOUNGE SEATING

SINGLE SEAT AND BENCH SPECIFICATIONS

Model:	PAS FS17 SS1 Single Seat	PAS FS2 BNS1 Single Bench
Dimensions		
Height	31.5"	17.5"
Width	27"	27"
Depth	27"	27"
Seat Depth	17.9"	27"
Seat Height	17.5"	17.5"
Back Height	14.5"	N/A
Materials		
COM (Fully Upholstered)	3 yd	2 yd
COM (Multi-Upholstery) Seat Only	2 yd	N/A
Back Only	1.56 yd	
Weight and Capacity		
Weight	64.5 lb	49 lb
Weight Capacity Warranty	400 lb	400 lb

1.5 SEAT AND BENCH SPECIFICATIONS

Model:	PAS FS17 SS2 1.5 Seat	PAS FS2 BNS2 1.5 Bench
Dimensions		
Height	31.5"	17.5"
Width	36"	36"
Depth	27"	27"
Seat Depth	17.9"	27"
Seat Height	17.5"	17.5"
Back Height	14.5"	N/A
Materials		
COM (Fully Upholstered)	4 yd	2.5 yd
COM (Multi-Upholstery) Seat Only	2.5 yd	N/A
Back Only	1.75 yd	
Weight and Capacity		
Weight	82.5 lb	58.5 lb
Weight Capacity Warranty	800 lb	800 lb

90-DEGREE SEAT AND BENCH SPECIFICATIONS

Model:	PAS FS17 SS5 90-Degree Corner Seat	PAS FS2 BNS5 90-Degree Corner Bench
Dimensions		
Height	31.5"	17.5"
Width	30"	42.5"
Depth	30"	27"
Seat Depth	17.9"	27"
Seat Height	17.5"	17.5"
Back Height	14.5"	N/A
Materials		
COM (Fully Upholstered)	5.25 yd	2.5 yd
COM (Multi-Upholstery)		
Seat Only	2.75 yd	N/A
Back Only	3 yd	
Weight and Capacity		
Weight	86 lb	47 lb
Weight Capacity Warranty	400 lb	400 lb

120-DEGREE SEAT AND BENCH SPECIFICATIONS

Model:	PAS FS17 SS3 120-Degree Inner Seat	PAS FS17 SS4 120-Degree Outer Seat	PAS FS2 BNS6 120-Degree Bench
Dimensions			
Height	31.5"	31.5"	17.5"
Width	47.5"	47.5"	47.5"
Depth	27"	27"	27"
Seat Depth	17.9"	17.9"	27"
Seat Height	17.5"	17.5"	17.5"
Back Height	14.5"	14.5"	N/A
Materials			
COM (Fully Upholstered)	4.38 yd	4.38 yd	2.5 yd
COM (Multi-Upholstery)			
Seat Only	2.75 yd	2.75 yd	N/A
Back Only	2.5 yd	2.5 yd	
Weight and Capacity			
Weight	87.5 lb	78 lb	63 lb
Weight Capacity Warranty	800 lb	800 lb	800 lb

MODULAR LOUNGE SEATING

ANGLED BENCH SPECIFICATIONS

	PAS FS2 BNS3 Right-Angled	PAS FS2 BNS4 Left-Angled
Dimensions		
Height	17.5"	17.5"
Width	47.5"	47.5"
Depth	27"	27"
Seat Depth	27"	27"
Seat Height	17.5"	17.5"
Materials		
COM (Single Upholstery)	2.5 yd	2.5 yd
Weight and Capacity		
Weight	61.5 lb	61.5 lb
Weight Capacity Warranty	800 lb	800 lb



Single Seat Bench

Paséa

TABLES AND OTTOMANS

Lounge that works.

Whether it's to rest your bag or your body, the modularity of the Paséa collection makes it easy to ensure there's always an extra place. This comprehensive collection includes a variety of ottomans and tables that pair perfectly with gapless seats and benches.



Mini Round Ottoman

Large Square Ottoman

EFFECTIVE OCTOBER 17, 2022

Featured Models

MINI ROUND OTTOMAN :: \$844

Mini round ottoman, multi-upholstery, grade 1 textiles

MINI ROUND OTTOMAN TABLE :: \$1,145

Mini round ottoman, grade 4 textile, laminate tabletop



LARGE SQUARE OTTOMAN :: \$1,685

Large square ottoman, multi-upholstery, grade 4 seat textile grade 3 chassis textile

Features

- Choose from an assortment of large and mini ottoman and table options, including square and round pieces
- Blend with any environment using graphite or slate base colors
- Tabletops come in five attractive laminate finishes
- Adjustable glides standard on large ottomans
- Fixed multi-surface glides standard on easy-to-move mini ottomans
- 400 lb weight capacity warranty (per seat)

1. Product

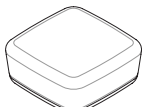
Model	Code	Price	
Mini Round Ottoman	PAS FS1 OS1	\$769	
Mini Square Ottoman	PAS FS1 OS3	\$769	
Large Round Ottoman	PAS FS1 OS2	\$1,472	
Large Square Ottoman	PAS FS1 OS4	\$1,472	

2. Base

Base Finish	Code	Price
Graphite	LBC2	+ \$0
Slate	LBC3	+ \$0

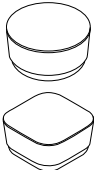
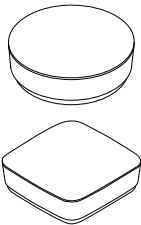

MODULAR TABLES AND OTTOMANS

3. Tabletop

Tabletop Material	Code	Price	
No Tabletop	TM0	+ \$0	
Mini Round or Square Laminate Top	TM3	+ \$328	
Large Round or Square Laminate Top	TM3	+ \$722	

Tabletop Finish	Code	Price	
Field Elm	TL13	+ \$0	
Uptown Walnut	TL14	+ \$0	
Skyline Walnut	TL15	+ \$0	
Frosty White	TL16	+ \$0	
Classic Linen	TL17	+ \$0	

4. Power

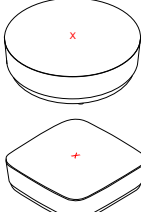
Power Type	Code	Price	
AC/110V and Dual USB	PT2	+ \$300	
Dual USB	PT3	+ \$175	
AC/110V	PT4	+ \$125	
Power Location	Code	Price	
Top Center	PTCC	Priced by Power Type	

Power is only available on large ottomans with tabletops. Power is located in the center of the laminate top.

5. Material

Protection	Code	Price	
Fire Retardancy		Mini Ottoman	Large Ottoman
CAL 133	UCAL	+ \$88	+ \$262
Cleaning	Code	Price	
Moisture Barrier		Mini Ottoman	Large Ottoman
Seat Only	UM2	+ \$35	+ \$177
Fully Upholstered	Code	Price	
Round		Mini Ottoman	Large Ottoman
Fabric/Vinyl Grade 1	FG1/VG1	+ \$0	+ \$0
COM	COM	+ \$38	+ \$72
Fabric/Vinyl Grade 2	FG2/VG2	+ \$38	+ \$72
Fabric/Vinyl Grade 3	FG3/VG3	+ \$59	+ \$112
Fabric/Vinyl Grade 4	FG4/VG4	+ \$84	+ \$161
Fabric/Vinyl Grade 5	FG5/VG5	+ \$126	+ \$241
Fabric/Vinyl Grade 6	FG6/VG6	+ \$168	+ \$322
Fabric/Vinyl Grade 7	FG7/VG7	+ \$210	+ \$402
Square		Mini Ottoman	Large Ottoman
Fabric/Vinyl Grade 1	FG1/VG1	+ \$0	+ \$0
COM	COM	+ \$40	+ \$74
Fabric/Vinyl Grade 2	FG2/VG2	+ \$40	+ \$74
Fabric/Vinyl Grade 3	FG3/VG3	+ \$63	+ \$115
Fabric/Vinyl Grade 4	FG4/VG4	+ \$90	+ \$165
Fabric/Vinyl Grade 5	FG5/VG5	+ \$135	+ \$247
Fabric/Vinyl Grade 6	FG6/VG6	+ \$180	+ \$330
Fabric/Vinyl Grade 7	FG7/VG7	+ \$225	+ \$412
Round or Square With Tabletop		Mini Ottoman	Large Ottoman
Fabric/Vinyl Grade 1	FG1/VG1	+ \$0	+ \$0
COM	COM	+ \$22	+ \$40
Fabric/Vinyl Grade 2	FG2/VG2	+ \$22	+ \$40
Fabric/Vinyl Grade 3	FG3/VG3	+ \$34	+ \$63
Fabric/Vinyl Grade 4	FG4/VG4	+ \$48	+ \$90
Fabric/Vinyl Grade 5	FG5/VG5	+ \$72	+ \$135
Fabric/Vinyl Grade 6	FG6/VG6	+ \$96	+ \$180
Fabric/Vinyl Grade 7	FG7/VG7	+ \$120	+ \$225

Cleaning and protection options are not applicable on ottomans with laminate tops.

5. Material (Cont.)

Multi-Upholstery	Code	Price	
Multi-Upholstery Upcharge	UMU	+ \$75	
Mini Round or Square Ottoman	Seat	Chassis	
Fabric/Vinyl Grade 1	FG1/VG1	+ \$0	+ \$0
COM	COM	+ \$22	+ \$22
Fabric/Vinyl Grade 2	FG2/VG2	+ \$22	+ \$22
Fabric/Vinyl Grade 3	FG3/VG3	+ \$34	+ \$34
Fabric/Vinyl Grade 4	FG4/VG4	+ \$48	+ \$48
Fabric/Vinyl Grade 5	FG5/VG5	+ \$72	+ \$72
Fabric/Vinyl Grade 6	FG6/VG6	+ \$96	+ \$96
Fabric/Vinyl Grade 7	FG7/VG7	+ \$120	+ \$120
Large Round or Square Ottoman	Seat	Chassis	
Fabric/Vinyl Grade 1	FG1/VG1	+ \$0	+ \$0
COM	COM	+ \$34	+ \$40
Fabric/Vinyl Grade 2	FG2/VG2	+ \$34	+ \$40
Fabric/Vinyl Grade 3	FG3/VG3	+ \$52	+ \$63
Fabric/Vinyl Grade 4	FG4/VG4	+ \$75	+ \$90
Fabric/Vinyl Grade 5	FG5/VG5	+ \$112	+ \$135
Fabric/Vinyl Grade 6	FG6/VG6	+ \$150	+ \$180
Fabric/Vinyl Grade 7	FG7/VG7	+ \$187	+ \$225

Ottomans with tabletops are only available fully upholstered.

If different fabrics are selected for the seat and chassis, add the multi-upholstery upcharge as well, even if the fabrics are the same grade

Please reference the Textile Reference Guide for pricing on fabric over grade 7. Additional CAL 133 information can be found on page 15.

6. Packaging

Packaging	Code	Price	
Fully Assembled in Carton	P1	+ \$0	

SPECIFICATIONS: MINI OTTOMAN

Model:	PAS FS1 OS1 Mini Round Ottoman	PAS FS1 OS3 Mini Square Ottoman
Dimensions		
Height	17.5"	17.5"
Width	24"	24"
Depth	24"	24"
Seat Depth	24"	24"
Seat Height	17.5"	17.5"
Materials		
COM (Fully Upholstered)	1.75 lb	1.88 yd
COM (Multi-Upholstery)		
Seat Top Only	1 yd	1 yd
Chassis Only	1 yd	1 yd
Weight and Capacity		
Weight	34 lb	43.5 lb
Weight Capacity Warranty	400 lb	400 lb

SPECIFICATIONS: LARGE OTTOMAN

Model:	PAS FS1 OS2 Large Round Ottoman	PAS FS1 OS4 Large Square Ottoman
Dimensions		
Height	17.5"	17.5"
Width	40"	40"
Depth	40"	40"
Seat Depth	40"	40"
Seat Height	17.5"	17.5"
Materials		
COM (Fully Upholstered)	3.35 yd	3.44 yd
COM (Multi-Upholstery)		
Seat Top Only	1.56 yd	1.56 yd
Chassis Only	1.88 yd	1.88 yd
Weight and Capacity		
Weight	74.5 lb	89.5 lb
Weight Capacity Warranty	800 lb	800 lb

MODULAR TABLES AND OTTOMANS

SPECIFICATIONS: MINI OTTOMAN TABLES

Model:	FS1 OS1 Mini Round Table	FS1 OS3 Mini Square Table
Dimensions		
Height	13"	13"
Width	24"	24"
Depth	24"	24"
Materials		
COM	1.25 yd	1.25 yd
Weight and Capacity		
Weight	37 lb	37 lb
Weight Capacity Warranty	400 lb	400 lb

SPECIFICATIONS: LARGE OTTOMAN TABLES

Model:	FS1 OS2 Large Round Table	FS1 OS4 Large Square Table
Dimensions		
Height	13.3"	13.3"
Width	40"	40"
Depth	40"	40"
Materials		
COM	2 yd	2 yd
Weight and Capacity		
Weight	85 lb	85 lb
Weight Capacity Warranty	800 lb	800 lb

Paséa

INLINE TABLES

Lounge that works.

Whether it's to rest your bag or your body, the modularity of the Paséa collection makes it easy to ensure there's always an extra place. This comprehensive collection includes a variety of inline tables that pair perfectly with gapless seats and benches.

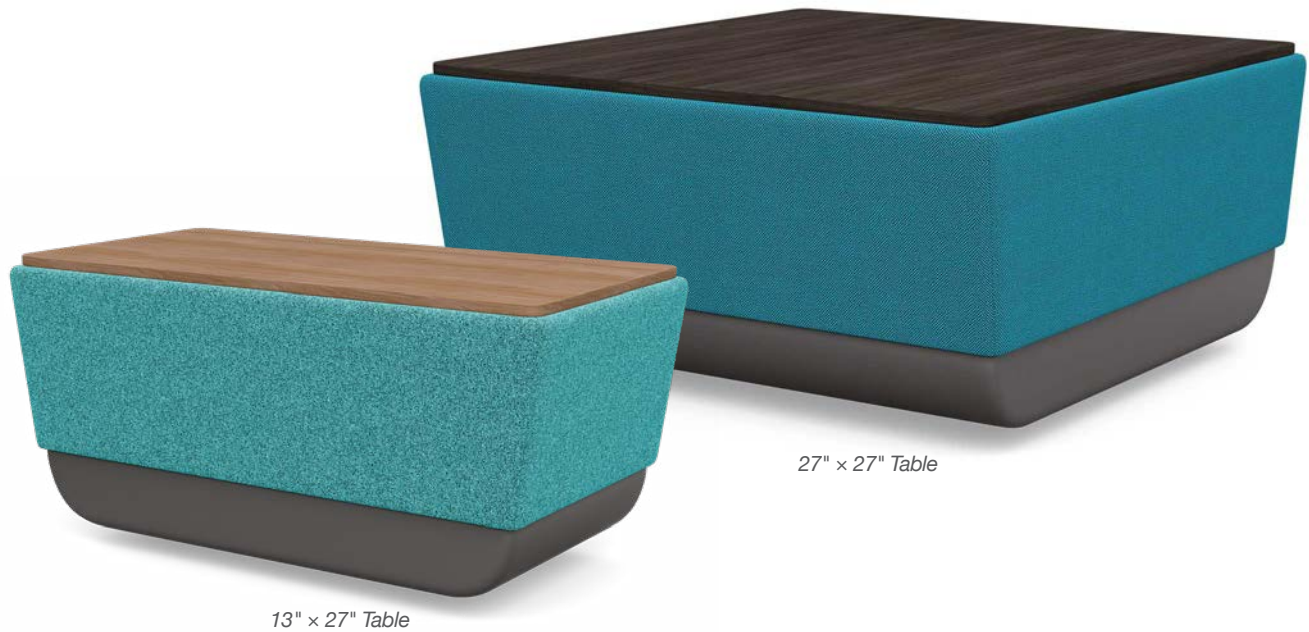

EFFECTIVE OCTOBER 17, 2022

Featured Models

13" x 27" :: \$1,204

13" x 27" table, laminate top, grade 1 textile

27" x 27" :: \$1,612

27" x 27" table, laminate top, grade 1 textile

90° CORNER :: \$2,495

90-degree corner table, laminate top, grade 1 textile

Features

- Choose from an assortment of large and mini ottoman
Designed by Q Design
- Part of a comprehensive collection that also includes seats, benches and ottomans
- Provide extra convenience with available AC and USB power options
- Three tables that are designed to be used inline with Paséa seats and benches: the 13" x 27" table, 27" x 27" table and the 90-degree corner table
- Adjustable glides standard on all Paséa tables (except mini ottoman tables).
- Blend with any environment using graphite or slate base colors
- Tabletops come in five attractive laminate finishes

1. Product

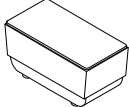
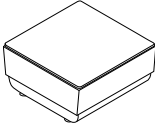
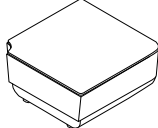
Model	Code	Price	
13" x 27" Table	FS18 BNS7	\$1,204	
27" x 27" Table	FS18 BNS1	\$1,612	
90-Degree Corner Table	FS18 BNS5	\$2,495	

2. Table Base

Base Finish	Code	Price
Graphite	LBC2	+ \$0
Slate	LBC3	+ \$0



INLINE TABLES

3. Tabletop

Top Material	Code	Price
Laminate	TM3	+ \$0

Laminate Finish	Code	Price
Field Elm	TL13	+ \$0
Uptown Walnut	TL14	+ \$0
Skyline Walnut	TL15	+ \$0
Frosty White	TL16	+ \$0
Classic Linen	TL17	+ \$0

4. Power

Power Type	Code	Price	
AC/110V and Dual USB	PT2	+ \$300	
Dual USB	PT3	+ \$175	
AC/110V	PT4	+ \$125	

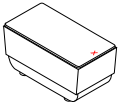
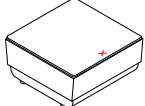
Power Location	Code	Price	
Top Rear	PTRC	Priced by Power Type	
Top Center	PTCC	Priced by Power Type	

13" x 27" (FS18 BNS7) and 27" x 27" (FS18 BNS1) tables are available with top rear power only. 90-degree corner table (FS18 BNS5) is available with top center power only.

5. Material

Fully Upholstered	Code	Price
13" x 27" Table		
Fabric/Vinyl Grade 1	FG1/VG1	+ \$0
COM	COM	+ \$27
Fabric/Vinyl Grade 2	FG2/VG2	+ \$27
Fabric/Vinyl Grade 3	FG3/VG3	+ \$42
Fabric/Vinyl Grade 4	FG4/VG4	+ \$60
Fabric/Vinyl Grade 5	FG5/VG5	+ \$90
Fabric/Vinyl Grade 6	FG6/VG6	+ \$120
Fabric/Vinyl Grade 7	FG7/VG7	+ \$150
27" x 27" Table		
Fabric/Vinyl Grade 1	FG1/VG1	+ \$0
COM	COM	+ \$40
Fabric/Vinyl Grade 2	FG2/VG2	+ \$40
Fabric/Vinyl Grade 3	FG3/VG3	+ \$63
Fabric/Vinyl Grade 4	FG4/VG4	+ \$90
Fabric/Vinyl Grade 5	FG5/VG5	+ \$135
Fabric/Vinyl Grade 6	FG6/VG6	+ \$180
Fabric/Vinyl Grade 7	FG7/VG7	+ \$225
90-Degree Corner Table		
Fabric/Vinyl Grade 1	FG1/VG1	+ \$0
COM	COM	+ \$40
Fabric/Vinyl Grade 2	FG2/VG2	+ \$40
Fabric/Vinyl Grade 3	FG3/VG3	+ \$63
Fabric/Vinyl Grade 4	FG4/VG4	+ \$90
Fabric/Vinyl Grade 5	FG5/VG5	+ \$135
Fabric/Vinyl Grade 6	FG6/VG6	+ \$180
Fabric/Vinyl Grade 7	FG7/VG7	+ \$225

Please reference the *Textile Reference Guide* for pricing on fabric over grade 7. Additional CAL 133 information can be found on page 15.

INLINE TABLES

6. Packaging

Packaging	Code	Price
Fully Assembled in Carton	P1	+ \$0

SPECIFICATIONS

Model:	FS18 BNS7 13" x 27" Table	FS18 BNS1 27" x 27" Table	FS18 BNS5 90-Degree Corner Table
Dimensions			
Height	13.3"	13.3"	13.3"
Width	13.4"	27"	30"
Depth	27"	27"	30"
Materials			
COM	1.25 yd	1.5 yd	1.5 yd
Weight and Capacity			
Weight	35 lb	64 lb	64 lb
Weight Capacity Warranty	400 lb	400 lb	400 lb

Visit Modular

CLUB CHAIR AND OTTOMAN

Sit. Stay awhile.

With contemporary aesthetics, the Visit Modular collection features flexible modularity and arm options for inventive space planning. Link arm and armless models with ganging brackets and an ottoman for common areas and waiting rooms. Handy seat-back handles and functional tablet arms make Visit Modular perfect for collaborative spaces and pull-up meetings.

Our customizable lounge line is now even more convenient thanks to our new power modules. Crafted with minimal seams for smoother integration and a cleaner look, they can be installed on either the fronts or sides of our models.



Armless Club Chair

EFFECTIVE OCTOBER 17, 2022

Featured Models

OTTOMAN :: \$1,304

Ottoman, fully upholstered, plastic feet, multi-upholstery, grade 5 top and front textile, grade 4 side textile

ARMLESS CLUB CHAIR :: \$2,024

Club chair, armless, wood tapered cylinder feet, multi-upholstery, grade 3 textiles

CLUB CHAIR WITH ARMS :: \$2,135

Club chair, two upholstered arms, brushed aluminum pole feet, fully upholstered, grade 3 textile

VISIT MODULAR

EFFECTIVE OCTOBER 17, 2022 | GSA SIN #: 33721

Features

- Armless chair and ottoman for modular seating
- Ganging brackets
- Two arm styles: armless or upholstered
- Optional tablet arm
- Back hook or handle
- Optional power module available
- 300 lb weight capacity warranty

1. Product

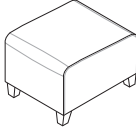
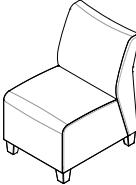
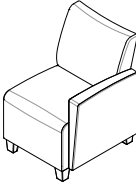
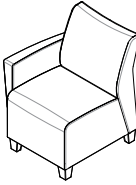
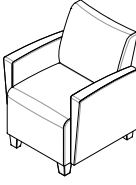
Model and Arm Style	Code	Price	
Ottoman	VS FS1	\$1,049	
Club Chair, Armless	VS	\$1,665	
Club Chair With Upholstered Left Arm	VS FS12	\$1,765	
Club Chair With Upholstered Right Arm	VS FS10	\$1,765	
Club Chair With Upholstered Left and Right Arms	VS FS8	\$1,865	



Left and right arms are designated from the seated position.

CLUB CHAIR AND OTTOMAN

2. Back

Back Options	Code	Price	
Hook/Handle (Not Available on Ottoman)	BX1	+ \$147	

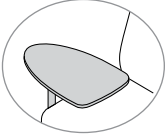
3. Tablet Arm

Tablet Arm	Code	Price	
Tablet Arm, Right, Black Pole	AX3	+ \$342	
Tablet Arm, Right, Silver Pole	AX2	+ \$342	
Tablet Arm, Left, Black Pole	AX6	+ \$342	
Tablet Arm, Left, Silver Pole	AX5	+ \$342	

Tablet arms are available on the left or right side if the chair is configured as armless.

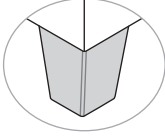
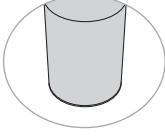
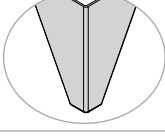
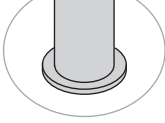

4. Foot

Front Foot Style and Color	Code	Price	
Feet			
Standard Plastic, Black	LS1	+ \$0	
Wood Tapered Square	LS12	+ \$70	
Wood Tapered Cylinder	LS11	+ \$70	
Metal Angular, Brushed Aluminum	LS6	+ \$60	
Metal 1.5" Pole, Brushed Aluminum	LS7	+ \$60	
Metal 1.5" Pole, Silver Powder Coat	LS8	+ \$60	

VISIT MODULAR

EFFECTIVE OCTOBER 17, 2022 | GSA SIN #: 33721

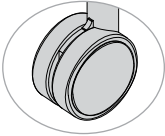
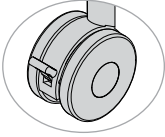
4. Foot (Cont.)

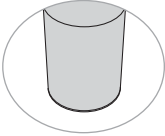
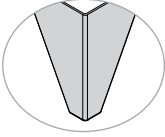
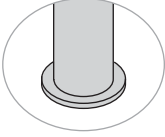
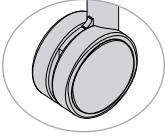
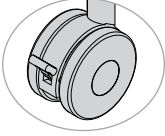
Front Foot Style and Color	Code	Price	
Casters			
Non-Locking Caster, Black	LS2	+ \$50	
Non-Locking Caster, Silver	LS3	+ \$50	
Locking Caster, Black	LS4	+ \$60	
Locking Caster, Silver	LS5	+ \$60	
Back Foot Style and Color			
Feet			
Standard Plastic, Black	LS1	+ \$0	
Wood Tapered Square	LS12	+ \$70	
Wood Tapered Cylinder	LS11	+ \$70	
Metal Angular, Brushed Aluminum	LS6	+ \$60	
Metal 1.5" Pole, Brushed Aluminum	LS7	+ \$60	
Metal 1.5" Pole, Silver Powder Coat	LS8	+ \$60	
Casters			
Non-Locking Caster, Black	LS2	+ \$50	
Non-Locking Caster, Silver	LS3	+ \$50	
Locking Caster, Black	LS4	+ \$60	
Locking Caster, Silver	LS5	+ \$60	

CLUB CHAIR AND OTTOMAN

5. Frame (For Wooden Feet L11/L12)

Frame Finish Color	Code	Price	
Clear Maple	FCW1	+ \$0	
Medium Cherry	FCW2	+ \$0	
Amber Mahogany	FCW3	+ \$0	
Espresso	FCW4	+ \$0	
Stain-to-Match	STM	+ \$70	
New Custom Stain	STL	+ \$275	

New Custom Stain (STL): If stain is not in our library, add this one-time fee in addition to the stain-to-match (STM) cost.

6. Power

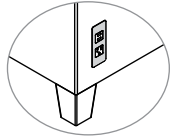
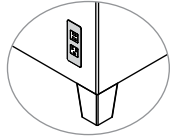
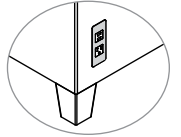
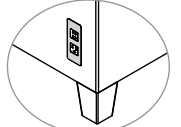
Location	Code	Price	
Right Hand, Front of Chair	PFR	+ \$250	
Left Hand, Front of Chair	PFL	+ \$250	
Right Hand, Side of Chair (Only Available on Armless Model)	PSR	+ \$250	
Left Hand, Side of Chair (Only Available on Armless Model)	PSL	+ \$250	

Color	Code	Price	
Silver	PC2	+ \$0	
Black	PC1	+ \$0	

Power only available on the side of chairs.

Each chair can only have power specified in one of the location options. Power cannot be specified on the same side of a chair where a tablet arm or magazine rack is specified.

7. Material

Protection	Code	Price	
Fire Retardancy			
CAL 133	UCAL	+ \$262	
Cleaning	Code	Price	
Moisture Barrier			
Seat Only	UM2	+ \$59	
Back Only	UM1	+ \$59	
Seat and Back	UM3	+ \$118	
Upholstery	Code	Price	
Fully Upholstered			Two Arms One Arm
Fabric/Vinyl Grade 1	FG1/VG1	+ \$0	+ \$0
COM	COM	+ \$50	+ \$39
Fabric/Vinyl Grade 2	FG2/VG2	+ \$50	+ \$39
Fabric/Vinyl Grade 3	FG3/VG3	+ \$150	+ \$119
Fabric/Vinyl Grade 4	FG4/VG4	+ \$250	+ \$198
Fabric/Vinyl Grade 5	FG5/VG5	+ \$375	+ \$298
Fabric/Vinyl Grade 6	FG6/VG6	+ \$550	+ \$439
Fabric/Vinyl Grade 7	FG7/VG7	+ \$775	+ \$616
Leather Grade 1	LG1	+ \$800	+ \$636
COL	COL	+ \$1,050	+ \$834
Leather Grade 2	LG2	+ \$1,050	+ \$834
Leather Grade 3	LG3	+ \$1,450	+ \$1,152
Fully Upholstered			Armless Ottoman
Fabric/Vinyl Grade 1	FG1/VG1	+ \$0	+ \$0
COM	COM	+ \$35	+ \$23
Fabric/Vinyl Grade 2	FG2/VG2	+ \$35	+ \$23
Fabric/Vinyl Grade 3	FG3/VG3	+ \$105	+ \$68
Fabric/Vinyl Grade 4	FG4/VG4	+ \$175	+ \$113
Fabric/Vinyl Grade 5	FG5/VG5	+ \$263	+ \$169
Fabric/Vinyl Grade 6	FG6/VG6	+ \$385	+ \$248
Fabric/Vinyl Grade 7	FG7/VG7	+ \$543	+ \$349
Leather Grade 1	LG1	+ \$556	+ \$363
COL	COL	+ \$730	+ \$476
Leather Grade 2	LG2	+ \$730	+ \$476
Leather Grade 3	LG3	+ \$1,008	+ \$657

CLUB CHAIR AND OTTOMAN

7. Material (Cont.)

Multi-Upholstery		Price	
Multi-Upholstery	UMU	+ \$113	
Seat or Top and Front Textile Only			Two Arms One Arm
Fabric/Vinyl Grade 1	FG1/VG1	+ \$0	+ \$0
COM	COM	+ \$15	+ \$15
Fabric/Vinyl Grade 2	FG2/VG2	+ \$15	+ \$15
Fabric/Vinyl Grade 3	FG3/VG3	+ \$45	+ \$45
Fabric/Vinyl Grade 4	FG4/VG4	+ \$74	+ \$74
Fabric/Vinyl Grade 5	FG5/VG5	+ \$111	+ \$111
Fabric/Vinyl Grade 6	FG6/VG6	+ \$163	+ \$163
Fabric/Vinyl Grade 7	FG7/VG7	+ \$229	+ \$229
Leather Grade 1	LG1	+ \$237	+ \$237
COL	COL	+ \$310	+ \$310
Leather Grade 2	LG2	+ \$310	+ \$310
Leather Grade 3	LG3	+ \$428	+ \$428
Seat or Top and Front Textile Only			Armless Ottoman
Fabric/Vinyl Grade 1	FG1/VG1	+ \$0	+ \$0
COM	COM	+ \$18	+ \$12
Fabric/Vinyl Grade 2	FG2/VG2	+ \$18	+ \$12
Fabric/Vinyl Grade 3	FG3/VG3	+ \$53	+ \$34
Fabric/Vinyl Grade 4	FG4/VG4	+ \$88	+ \$57
Fabric/Vinyl Grade 5	FG5/VG5	+ \$132	+ \$85
Fabric/Vinyl Grade 6	FG6/VG6	+ \$193	+ \$124
Fabric/Vinyl Grade 7	FG7/VG7	+ \$272	+ \$175
Leather Grade 1	LG1	+ \$278	+ \$182
COL	COL	+ \$365	+ \$238
Leather Grade 2	LG2	+ \$365	+ \$238
Leather Grade 3	LG3	+ \$504	+ \$329

If different fabrics are selected for the seat and back, add the multiple upholstery upcharge as well, even if the fabrics are the same grade

Please reference the *Textile Reference Guide* for pricing on fabric over grade 7 and leather over grade 3. Additional CAL 133 information can be found on page 15.



Ottoman

7. Material (Cont.)

Multi-Upholstery	Code	Price	
Back or Side Textile Only		Two Arms	One Arm
Fabric/Vinyl Grade 1	FG1/VG1	+ \$0	+ \$0
COM	COM	+ \$15	+ \$15
Fabric/Vinyl Grade 2	FG2/VG2	+ \$15	+ \$15
Fabric/Vinyl Grade 3	FG3/VG3	+ \$45	+ \$45
Fabric/Vinyl Grade 4	FG4/VG4	+ \$74	+ \$74
Fabric/Vinyl Grade 5	FG5/VG5	+ \$111	+ \$111
Fabric/Vinyl Grade 6	FG6/VG6	+ \$163	+ \$163
Fabric/Vinyl Grade 7	FG7/VG7	+ \$229	+ \$229
Leather Grade 1	LG1	+ \$237	+ \$237
COL	COL	+ \$310	+ \$310
Leather Grade 2	LG2	+ \$310	+ \$310
Leather Grade 3	LG3	+ \$428	+ \$428
Back or Side Textile Only		Armless	Ottoman
Fabric/Vinyl Grade 1	FG1/VG1	+ \$0	+ \$0
COM	COM	+ \$18	+ \$12
Fabric/Vinyl Grade 2	FG2/VG2	+ \$18	+ \$12
Fabric/Vinyl Grade 3	FG3/VG3	+ \$53	+ \$34
Fabric/Vinyl Grade 4	FG4/VG4	+ \$88	+ \$57
Fabric/Vinyl Grade 5	FG5/VG5	+ \$132	+ \$85
Fabric/Vinyl Grade 6	FG6/VG6	+ \$193	+ \$124
Fabric/Vinyl Grade 7	FG7/VG7	+ \$272	+ \$175
Leather Grade 1	LG1	+ \$278	+ \$182
COL	COL	+ \$365	+ \$238
Leather Grade 2	LG2	+ \$365	+ \$238
Leather Grade 3	LG3	+ \$504	+ \$329
Arm/Arms Textile Only		Two Arms	One Arm
Fabric/Vinyl Grade 1	FG1/VG1	+ \$0	+ \$0
COM	COM	+ \$21	+ \$11
Fabric/Vinyl Grade 2	FG2/VG2	+ \$21	+ \$11
Fabric/Vinyl Grade 3	FG3/VG3	+ \$62	+ \$31
Fabric/Vinyl Grade 4	FG4/VG4	+ \$103	+ \$52
Fabric/Vinyl Grade 5	FG5/VG5	+ \$154	+ \$77
Fabric/Vinyl Grade 6	FG6/VG6	+ \$226	+ \$113
Fabric/Vinyl Grade 7	FG7/VG7	+ \$318	+ \$159
Leather Grade 1	LG1	+ \$328	+ \$164
COL	COL	+ \$431	+ \$216
Leather Grade 2	LG2	+ \$431	+ \$216
Leather Grade 3	LG3	+ \$595	+ \$298

If different fabrics are selected for the seat and back, add the multiple upholstery upcharge as well, even if the fabrics are the same grade.

Please reference the Textile Reference Guide for pricing on fabric over grade 7 and leather over grade 3. Additional CAL 133 information can be found on page 15.

CLUB CHAIR AND OTTOMAN

8. Options

Ganging Bracket	Code	Price
One Set of Ganging Brackets, Left-Attaching	XGVL	+ \$52
One Set of Ganging Brackets, Right-Attaching	XGVR	+ \$52
Two Sets of Ganging Brackets, One Set Left-Attaching and One Set Right-Attaching	XGV	+ \$103

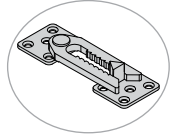

SPECIFICATIONS: WITH ARMS

Model:	VS FS8 Club Chair With 2 Upholstered Arms	VS FS11 / VS FS12 Club Chair With 1 Upholstered Arm
Dimensions		
Height	35"	35"
Width	28.5"	28.5"
Depth	29"	29"
Seat Width	22"	22"
Seat Depth	21"	21"
Seat Height	19.5"	19.5"
Back Height	17"	17"
Arm Height	26.5"	26.5"
Materials		
COM		
Fully Upholstered	5.4 yd	4.25 yd
Seat Only	1.9 yd	1.9 yd
Back Only	2.2 yd	2.2 yd
Arms Only	2.9 yd	1.75 yd
Side Only	N/A	N/A
Seat and Side Only	N/A	N/A
COL		
Fully Upholstered	83.3 sq ft	72 sq ft
Seat Only	29.4 sq ft	29.4 sq ft
Back Only	34.3 sq ft	34.3 sq ft
Arms Only	44.1 sq ft	26 sq ft
Side Only	N/A	N/A
Seat and Side Only	N/A	N/A
Weight and Capacity		
Weight	48 lb	43 lb
Weight Capacity	300 lb	300 lb
Warranty (Per Seat)		

Yardage requirements for COM and COL are for solid and non-directional fabrics. Additional material may be required for larger repeating patterns.

EFFECTIVE OCTOBER 17, 2022 | GSA SIN #: 33721

SPECIFICATIONS: NO ARMS

Model:	VS Armless Club Chair	VS S1 Ottoman
Dimensions		
Height	35"	N/A
Width	22.5"	N/A
Depth	29"	N/A
Seat Width	22"	22"
Seat Depth	21"	21"
Seat Height	19.5"	17.5"
Back Height	17"	N/A
Arm Height	N/A	N/A
Materials		
COM		
Fully Upholstered	3.5 yd	1.88 yd
Seat Only	1.9 yd	N/A
Back Only	2.2 yd	N/A
Side Only	N/A	0.94 yd
Seat and Side Only	N/A	1.88 yd
COL		
Fully Upholstered	54.5 sq ft	29.4 sq ft
Seat Only	29.4 sq ft	N/A
Back Only	34.3 sq ft.	N/A
Side Only	N/A	14.7 sq ft
Seat and Side Only	N/A	29.4 sq ft
Weight and Capacity		
Weight	38 lb	28 lb
Weight Capacity	300 lb	300 lb
Warranty (Per Seat)		

Yardage requirements for COM and COL are for solid and non-directional fabrics. Additional material may be required for larger repeating patterns.



Club Chair With Arms

Tables and Desks

COFFEE TABLE | END TABLE
HEIGHT-ADJUSTABLE TABLE
MULTIPURPOSE TABLE
DESK AND RETURN

Statement of Line

COFFEE TABLE | END TABLE | CAFÉ TABLE | MULTIPURPOSE TABLE
HEIGHT-ADJUSTABLE TABLE | DESK AND RETURN

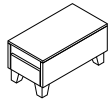

Mezzanine

Cube End Table
Plastic/Wood Tapered Square Feet
MCM TT1 LS1/LS12
Page 409

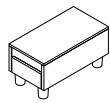

Mezzanine

Cube End Table
Tapered Cylinder Feet
MCM TT1 LS11
Page 409

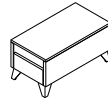

Mezzanine

Cube End Table
Angular Feet
MCM TT1 LS6
Page 409

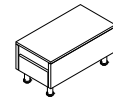

Mezzanine

Cube End Table
Pole Feet
MCM TT1 LS7/LS8
Page 409

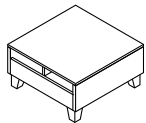

Mezzanine

Cube Coffee Table
Plastic/Wood Tapered Square Feet
MCM TT2 LS1/LS12
Page 409

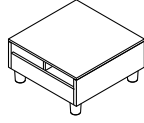

Mezzanine

Cube Coffee Table
Tapered Cylinder Feet
MCM TT2 LS11
Page 409

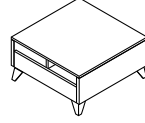

Mezzanine

Cube Coffee Table
Angular Feet
MCM TT2 LS6
Page 409

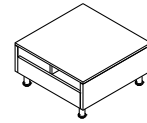

Mezzanine

Cube Coffee Table
Pole Feet
MCM TT2 LS7/LS8
Page 409

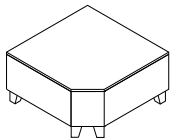

Mezzanine

Cube Corner Table
Plastic/Wood Tapered Square Feet
MCM TT3 LS1/LS12
Page 409

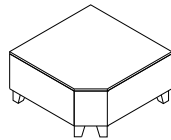

Mezzanine

Cube Corner Table
Tapered Cylinder Feet
MCM TT3 LS1/LS12
Page 409

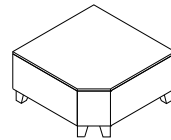

Mezzanine

Cube Corner Table
Angular Feet
MCM TT3 LS6
Page 409

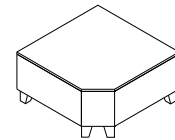

Mezzanine

Cube Corner Table
Pole Feet
MCM LS7/LS8
Page 409

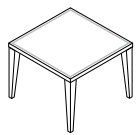

Mezzanine

Square Occasional Table
Wood Tapered Square Legs
MZM TT8 LSL2
Page 412

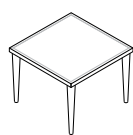

Mezzanine

Square Occasional Table
Wood Tapered Cylinder Legs
MZM TT8 LSL3
Page 412

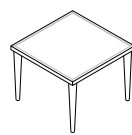

Mezzanine

Square Occasional Table
Pole Legs
MZM TT8 LSL1
Page 412

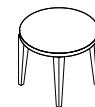

Mezzanine

Round Occasional Table
Wood Tapered Square Legs
MZM TT6 LSL2
Page 412

Statement of Line

COFFEE TABLE | END TABLE | CAFÉ TABLE | MULTIPURPOSE TABLE
HEIGHT-ADJUSTABLE TABLE | DESK AND RETURN



Mezzanine

Round Occasional Table
Wood Tapered Cylinder Legs
MZM TT6 LSL3
Page 412

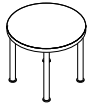

Mezzanine

Round Occasional Table
Pole Legs
MZM TT6 LSL1
Page 412

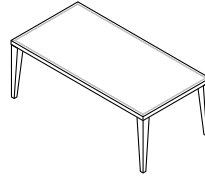

Mezzanine

Rectangular Occasional Table
Wood Tapered Square Legs
MZM TT5 LSL2
Page 412

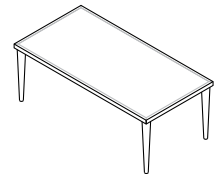

Mezzanine

Rectangular Occasional Table
Wood Tapered Cylinder Legs
MZM TT5 LSL3
Page 412

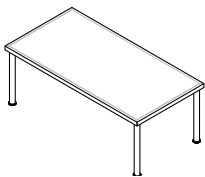

Mezzanine

Rectangular Occasional Table
Pole Legs
MZM TT5 LSL1
Page 412

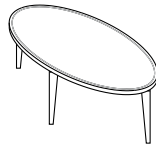

Mezzanine

Oval Occasional Table
Wood Tapered Square Legs
MZM TT4 LSL2
Page 412

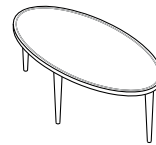

Mezzanine

Oval Occasional Table
Wood Tapered Cylinder Legs
MZM TT5 LSL3
Page 412

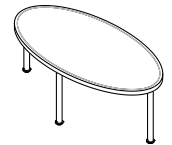

Mezzanine

Pole Legs
Wood Tapered Square Legs
MZM TT5 LSL1
Page 412

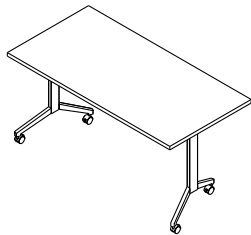

Ocala

Rectangular Top
Flip-Top Base
3061 TBT2
Page 415

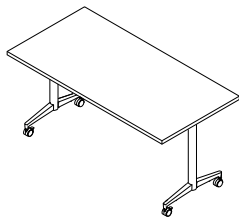

Parallon Training

Rectangular Tabletop
Fixed/Flip-Top T-Leg Base
3271/3272 TZ TBT2/TBT3
Page 423

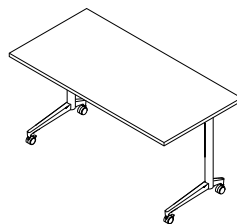

Parallon Training

Rectangular Tabletop
Fixed C-Leg Base
3271/3272 TZ TBT3C
Page 423

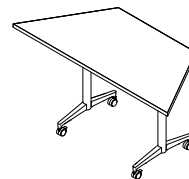

Parallon Training

Trapezoid Tabletop
Fixed/Flip-Top T-Leg Base
3271/3272 TPZ TBT2/TBT3
Page 423

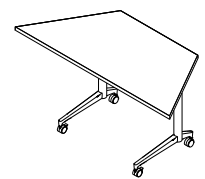

Parallon Training

Trapezoid Tabletop
Fixed C-Leg Base
3271/3272 TPZ TBT3C
Page 423

Statement of Line

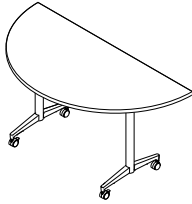

Parallon Training

Half-Round Tabletop
Fixed/Flip-Top T-Leg Base
3271/3272 THR TBT2/TBT3
Page 423

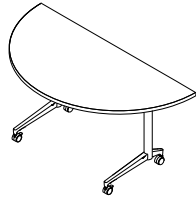

Parallon Training

Half-Round Tabletop
Fixed C-Leg Base
3271/3272 THR TBT3C
Page 423

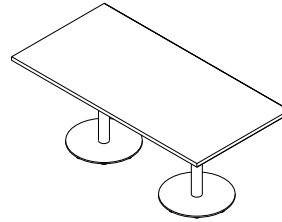

Parallon Meeting

Rectangular Tabletop
Standard-Height Dual-Disc Base
3271/3272 THR TBT2/TBT3
Page 430

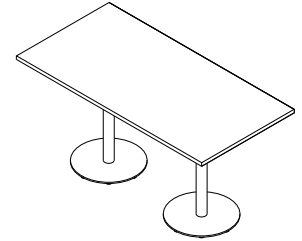

Parallon Meeting

Rectangular Tabletop
Counter-Height Dual-Disc Base
3271/3272 THR TBT2/TBT3
Page 430

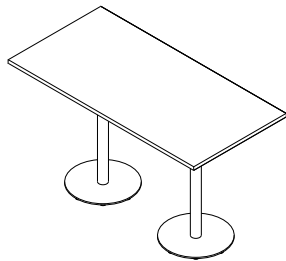

Parallon Meeting

Rectangular Tabletop
Bar-Height Dual-Disc Base
3271/3272 THR TBT2/TBT3
Page 430

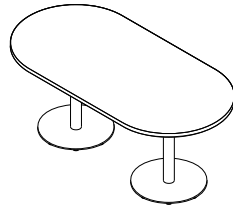

Parallon Meeting

Racetrack Tabletop
Standard-Height Dual-Disc Base
3271/3272 THR TBT2/TBT3
Page 430

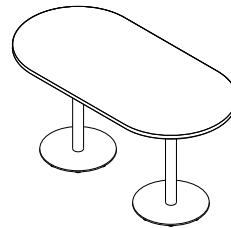

Parallon Meeting

Racetrack Tabletop
Counter-Height Dual-Disc Base
3271/3272 THR TBT2/TBT3
Page 430

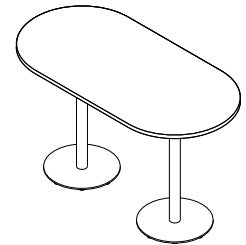

Parallon Meeting

Racetrack Tabletop
Bar-Height Dual-Disc Base
3271/3272 THR TBT2/TBT3
Page 430



Parallon Café

Square Tabletop
Occasional X-Base
3271/3272 TS TBT4 TH16/TH20
Page 430

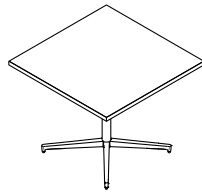

Parallon Café

Square Tabletop
Standard-Height X-Base
3271/3272 TS TBT4/TBT4P TH29
Page 430

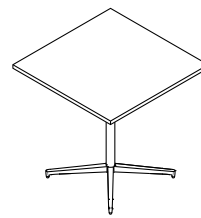

Parallon Café

Square Tabletop
Counter-Height X-Base
3271/3272 TS TBT4/TBT4P TH36
Page 430

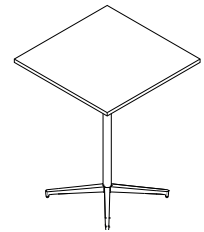

Parallon Café

Square Tabletop
Bar-Height X-Base
3271/3272 TS TBT4/TBT4P TH42
Page 430

Statement of Line

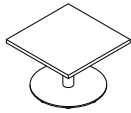

Parallon Café

Square Tabletop
Occasional Disc-Base
3271/3272 TS TBT16/TBT16P TH16/TH20
Page 430

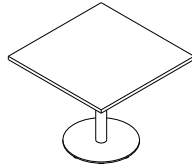

Parallon Café

Square Tabletop
Standard-Height Disc-Base
3271/3272 TS TBT15/TBT15P TH29
Page 430

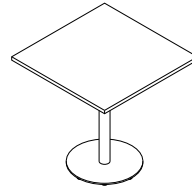

Parallon Café

Square Tabletop
Counter-Height X-Base
3271/3272 TS TBT15/TBT15P TH36
Page 430

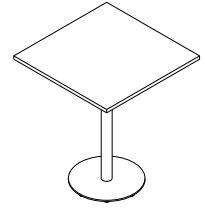

Parallon Café

Square Tabletop
Bar-Height Disc-Base
3271/3272 TS TBT15/TBT15P TH42
Page 430



Parallon Café

Round Tabletop
Occasional X-Base
3271/3272 TR TBT4 TH16/TH20
Page 430



Parallon Café

Round Tabletop
Standard-Height X-Base
3271/3272 TR TBT4/TBT4P TH29
Page 430



Parallon Café

Round Tabletop
Counter-Height X-Base
3271/3272 TR TBT4/TBT4P TH36
Page 430

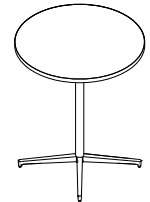

Parallon Café

Round Tabletop
Bar-Height X-Base
3271/3272 TR TBT4/TBT4P TH42
Page 430

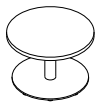

Parallon Café

Round Tabletop
Occasional Disc-Base
3271/3272 TR TBT16/TBT16P TH16/TH20
Page 430

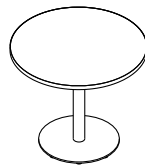

Parallon Café

Round Tabletop
Occasional Disc-Base
3271/3272 TR TBT16/TBT16P TH29
Page 430

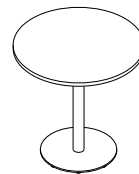

Parallon Café

Round Tabletop
Occasional Disc-Base
3271/3272 TR TBT16/TBT16P TH36
Page 430

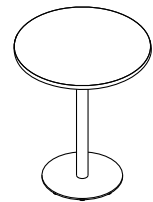

Parallon Café

Round Tabletop
Occasional Disc-Base
3271/3272 TR TBT16/TBT16P TH42
Page 430

Statement of Line

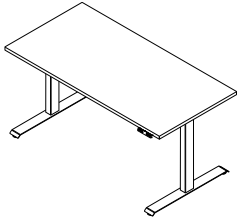

Surge

Rectangular Tabletop
2-Leg T-Leg
3301/3302 TZ TBT6
Page 435

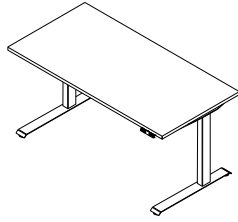

Surge

Rectangular Tabletop
2-Leg C-Leg
3301/3302 TZ TBT6C
Page 435

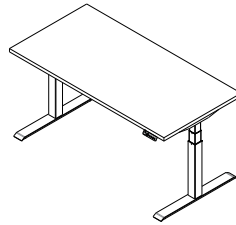

Switchback

Rectangular Tabletop
2-Leg T-Leg
3161/3162 TZ TBT6/TBT7
Page 445

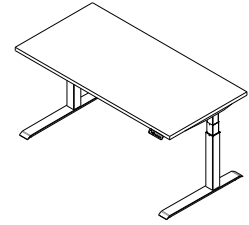

Switchback

Rectangular Tabletop
2-Leg C-Leg
3161/3162 TZ TBT6C/TBT7C
Page 445

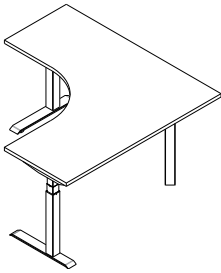

Switchback

90-Degree Tabletop
3-Leg C-Leg
3161/3162 TA
Page 453

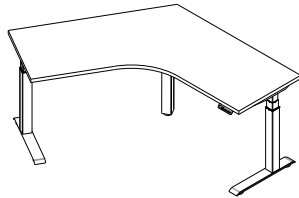

Switchback

120-Degree Tabletop
3-Leg C-Leg
3161/3162 TA
Page 453

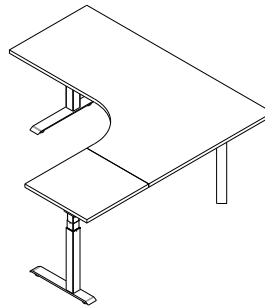

Switchback

Extended Left Corner
3-Leg C-Leg
3161/3162 OL
Page 471

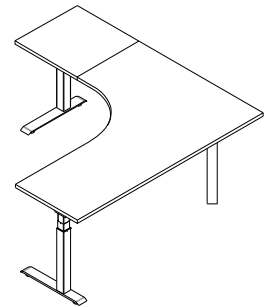

Switchback

Extended Right Corner With Return
3-Leg C-Leg
3161/3162 TXR
Page 453

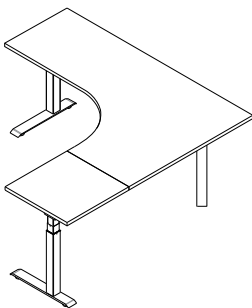

Switchback

Extended Left Corner With Return
3-Leg C-Leg
3161/3162 TXL
Page 453

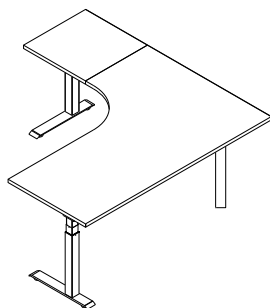

Switchback

Extended Right Corner
3-Leg C-Leg
3161/3162 OR
Page 453

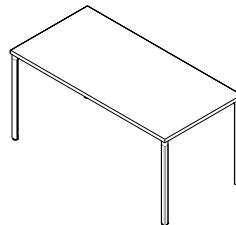

Tensor Multipurpose

Extended Left Corner With Return
3-Leg C-Leg
3231/3232 TBT9 TZ
Page 471

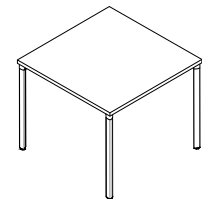

Tensor Café

Square Tabletop
3231/3232 TBT9 TS
Page 467

Statement of Line

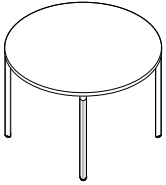

Tensor Café

Round Tabletop
3231/3232 TBT9 TR
[Page 467](#)



Uni

Laptop Table
3260 TT9
[Page 485](#)

Mezzanine

END TABLE, COFFEE TABLE AND CORNER TABLE

Get in top shape.

Mezzanine® tables are available in two popular styles—cube and occasional. From the modernist cube to the transitional occasional style, these accent pieces are designed to complement any SitOnIt Seating chair, settee or sofa. Built with the highest quality veneers and hardwoods, Mezzanine tables are designed to withstand the repeated use required of high traffic lobbies and waiting areas. Add a finishing touch to any space with tables as distinctive as your seating.



Coffee Table

EFFECTIVE OCTOBER 17, 2022

Featured Models

END TABLE :: \$1,157

End table, standard black plastic feet

COFFEE TABLE :: \$1,595

Coffee table, wood tapered square feet

CORNER TABLE :: \$1,871

Corner table, brushed aluminum pole feet

Features

- Three functional cube designs
- Four finishes
- 10 foot/caster styles

1. Product

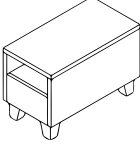
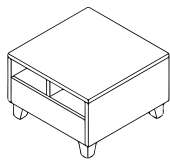
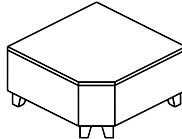
Table Type	Code	Price	
End Table	MCM TT1	\$1,157	
Coffee Table	MCM TT2	\$1,455	
Corner Table	MCM TT3	\$1,751	



End Table





END TABLE, COFFEE TABLE AND CORNER TABLE

2. Appearance

Table Finish Color	Code	Price	
Clear Maple	FCW1	+ \$0	
Medium Cherry	FCW2	+ \$0	
Amber Mahogany	FCW3	+ \$0	
Espresso	FCW4	+ \$0	
Stain-to-Match	STM	+ \$70	
New Custom Stain	STL	+ \$275	

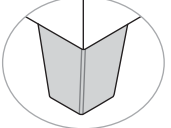
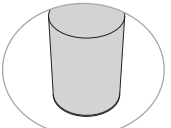
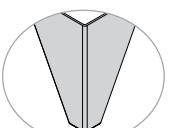
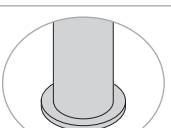
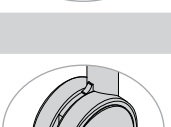
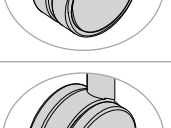
New Custom Stain (STL): If stain is not in our library, add this one-time \$275 net fee in addition to the \$70 stain-to-match (STM) cost.

2. Feet

Foot Style and Color	Code	Price	
Feet			
Standard Plastic, Black	LS1	+ \$0	
Wood Tapered Square	LS12	+ \$140	
Wood Tapered Cylinder	LS11	+ \$140	
Metal Angular, Brushed Aluminum	LS6	+ \$120	
Metal 1.5" Pole, Brushed Aluminum	LS7	+ \$120	
Metal 1.5" Pole, Silver Powder Coat	LS8	+ \$120	
Castors			
Non-Locking Caster, Black	LS2	+ \$100	
Non-Locking Caster, Silver	LS3	+ \$100	
Locking Caster, Black	LS4	+ \$120	
Locking Caster, Silver	LS5	+ \$120	

EFFECTIVE OCTOBER 17, 2022 | GSA SIN #: 33721

3. Options

Ganging Brackets	Code	Price
One Set, Left-Attaching	XGVL	+ \$52
One Set, Right-Attaching	XGVR	+ \$52
Two Sets, Left- and Right-Attaching	XGV	+ \$103

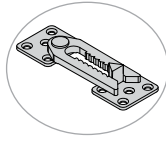

4. Packaging

Packaging	Code	Price
Knocked Down	P7	+ \$0

SPECIFICATIONS

Model:	MCM TT1 End Table	MCM TT2 Coffee Table	MCM TT3 Corner Table
Height	17"	17"	17"
Width	13.5"	25"	31.5"
Depth	25"	25"	31.5"
Weight	35 lb	52 lb	59 lb



Corner Table

Mezzanine

OCCASIONAL TABLE

Get in top shape.

Mezzanine® tables are available in two popular styles—cube and occasional. From the modernist cube to the transitional occasional style, these accent pieces are designed to complement any chair, settee or sofa. Built with the highest quality veneers and hardwoods, Mezzanine tables are designed to withstand the repeated use required of high traffic lobbies and waiting areas. Add a finishing touch to any space with tables as distinctive as your seating.



Square Occasional Table

EFFECTIVE OCTOBER 17, 2022

Featured Models

SQUARE :: \$1,594

Square occasional table, 21" tabletop, 24" high, wood tapered square legs

RECTANGULAR :: \$2,096

Rectangular occasional table, 48" tabletop, 24" high, wood tapered square legs





OVAL :: \$2,196

Oval occasional table, 48" tabletop, 18" high, brushed aluminum pole legs

Features

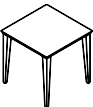
- Four occasional table shapes
- Three edge types
- Three leg styles
- Four wood stain finishes and stain-to-match program

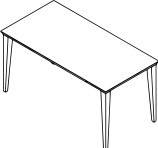
1. Product

Table Type	Code	Price	
Square Occasional Table	MZM TT8	\$1,534	
Round Occasional Table	MZM TT6	\$1,534	
Rectangular Occasional Table	MZM TT5	\$2,036	
Oval Occasional Table	MZM TT4	\$2,036	

2. Size

Table Top Size	Code	Price	
For Square and Round Tables			
21"	TZ21	+\$0	
24"	TZ24	+\$99	
36"	TZ36	+\$495	
For Rectangular and Oval Tables			
48"	TZ48	+\$0	
Table Height	Code	Price	
16"	TH16	+\$0	
18"	TH18	+\$20	
21"	TH21	+\$40	
24"	TH24	+\$60	

OCCASIONAL TABLES

3. Appearance

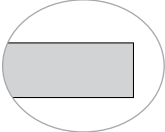
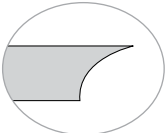
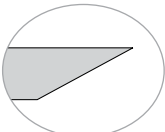
Table Top Edge Style	Code	Price	
Square	TE1	+\$0	
Bevel	TE2	+\$0	
Knife	TE3	+\$0	

Finish Color	Code	Price	
Clear Maple	FCW1	+\$0	
Medium Cherry	FCW2	+\$0	
Amber Mahogany	FCW3	+\$0	
Espresso	FCW4	+\$0	
Stain-to-Match	STM	+\$70	
New Custom Stain	STL	+\$275	

New Custom Stain (STL): If stain is not in our library, add this one-time \$275 net fee in addition to the \$70 stain-to-match (STM) cost.

4. Legs

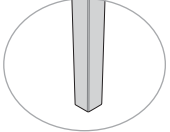
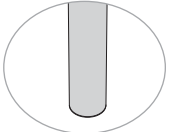
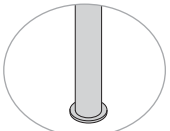
Leg Style	Code	Price	
Wood Tapered Square Leg	LSL2	+\$0	
Wood Tapered Cylinder Leg	LSL3	+\$0	
Metal 1.5" Pole, Brushed Aluminum Leg	LSL1	+\$140	

5. Options

Protection	Code	Price
Protective Wood Guard Clear Tape	LX1	+ \$84

Protective Wood Guard (LX1) is available on wood legs (LSL2/LSL3) only.

4. Packaging

Packaging	Code	Price
Knocked Down	P7	+ \$0

OCCASIONAL TABLES

SPECIFICATIONS

Model:	MZM TT8 Square Table		
	21"	24"	36"
Width	21"	24"	36"
Depth	21"	24"	36"
Weight	30 lb	34 lb	57 lb
Model:	MZM TT6 Round Table		
	21"	24"	36"
Width	21"	24"	36"
Depth	21"	24"	36"
Weight	27 lb	30 lb	48 lb
Model:	MZM TT5 Rectangular Table		
Width	48"		
Depth	24"		
Weight	52 lb		
Model:	MZM TT4 Oval Table		
Width	48"		
Depth	24"		
Weight	52 lb		

Square, round, rectangular and oval tables are available in multiple heights.



Rectangular Occasional Table

Ocala

FLIP-TOP TABLES

Mighty and mobile.

The Ocala flip-top table is the simple yet sophisticated nesting table that solves all of your training and meeting room needs. Set-up takes just seconds—table surface flips and locks with the pull of a lever. The table nests for convenient, space-saving storage.



24" x 60"

Chair sold separately; see [page 255](#) for Movi.

EFFECTIVE OCTOBER 17, 2022

Featured Models

24" x 60" :: \$946

24" x 60" top, grade 1 laminate, flip-top base, no grommets

30" x 72" :: \$1,106

30" x 72" top, grade 1 laminate, flip-top base, no grommets

Features

- Welded and bolted construction with steel end caps
- Multiple laminate options to fit your style
- Optional grommets for easy and clean setup of electronic devices
- Silver and white base finishes
- Casters are standard on all models
- 60", 66" and 72" top lengths
- 130 lb weight capacity warranty

SPECIFICATIONS

	3061 TBT2 Ocala Flip-Top Table
Height	28.59"
Height With Top Flipped Up	41.11"
Base Length	58.99"
Foot Length:	21.9"
Base Top Support Length:	52.84"
Distance Between Legs:	50.15"
Weight Capacity Warranty	130 lb

Height includes 1.125" tabletop and casters.

See the Stand-Alone Tabletop appendix on [page 588](#) for tabletop weights.

TABLETOP

TOPS AND BASES ARE SPECIFIED AND SOLD SEPARATELY.

1. Product

Product Type	Code	Price
Tabletop	3061 TBT2	Priced by Size

2. Finish

Laminate	Code	Price
Grade 1 Laminate		
Ankara Cherry	TL18	Priced by Size
Black	TL19	Priced by Size
Brazilian Walnut	TL20	Priced by Size
Cabinet Maple	TL21	Priced by Size
Driftwood	TL23	Priced by Size
Folkstone Grey	TL24	Priced by Size
Libretti	TL25	Priced by Size
Queenston Oak	TL26	Priced by Size
Sandalwood	TL27	Priced by Size
Walnut Amati	TL28	Priced by Size
White	TL29	Priced by Size
Grade 2 Laminate		
Classic Linen	TL17	Priced by Size
Colombian Walnut	TL55	Priced by Size
Crisp Linen	TL64	Priced by Size
Designer White	TL66	Priced by Size
Field Elm	TL13	Priced by Size
Frosty White	TL16	Priced by Size
Grey	TL62	Priced by Size
Grey Elm	TL51	Priced by Size
Kingswood Walnut	TL53	Priced by Size
Manitoba	TL56	Priced by Size
Neo Walnut	TL50	Priced by Size
Platinum	TL61	Priced by Size
Portico Teak	TL60	Priced by Size
Skyline Walnut	TL15	Priced by Size
Steel Mesh	TL59	Priced by Size
Tuscan Walnut	TL57	Priced by Size
Uptown Walnut	TL14	Priced by Size
Laminate Grade	Code	Price
Laminate Grade 1	GR1	Priced by Size
Laminate Grade 2	GR2	Priced by Size

EFFECTIVE OCTOBER 17, 2022

TABLETOP

TOPS AND BASES ARE SPECIFIED AND SOLD SEPARATELY.

3. Shape

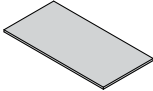
Product Type	Code	Price	
Rectangular Tabletop	TZ	Priced by Size	

4. Size

Tabletop Size (D x W)	Code	Price	
Rectangular Tabletop		Grade 1	Grade 2
24" x 60"	2460	\$324	\$486
24" x 66"	2466	\$358	\$537
24" x 72"	2472	\$389	\$584
30" x 60"	3060	\$404	\$606
30" x 66"	3066	\$445	\$668
30" x 72"	3072	\$484	\$726

5. Grommets

Grommet Location	Code	Price	
None	GP00	+ \$0	
Left	GP01	+ \$30	
Center	GP02	+ \$30	
Right	GP03	+ \$30	
Left and Center	GP04	+ \$60	
Left and Right	GP05	+ \$60	
Right and Center	GP06	+ \$60	
Left, Right and Center	GP07	+ \$90	

Grommet Color	Code	Price	
Black	GC01	+ \$0	
White	GC02	+ \$0	

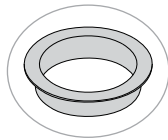

EFFECTIVE OCTOBER 17, 2022

1. Product

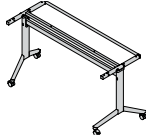
Product Type	Code	Price	
Flip-Top Base	3062 TBT2	\$622	

2. Finish

Paint Color	Code	Price
Silver	BF01	+ \$0
White	BF02	+ \$0

TABLE BASE

TOPS AND BASES ARE SPECIFIED AND SOLD SEPARATELY.

3. Matching Tabletop

Tabletop Shape	Code	Price
Matching Tabletop	TZ	+ \$0
Tabletop Size (D x W)	Code	Price
24" x 60"	TZ2460	+ \$0
24" x 66"	TZ2466	+ \$0
24" x 72"	TZ2472	+ \$0
30" x 60"	TZ3060	+ \$0
30" x 66"	TZ3066	+ \$0
30" x 72"	TZ3072	+ \$0

Bases require the specification of a tabletop size. Bases take their size from their corresponding tabletop.

1. Additional Options (Sold Separately)

Product Type	Code	Price	
Pair of Ganging Brackets	3159 XGV	\$50	



Parallon

TYPICALS

Everything to the table.

When you want cohesion in spaces large, small, shared or separate, there's Parallon. It's a single collection with a singular look, offering an array of choices for a variety of environments—and all the features to fit. Continue the cohesion even when it's time to “take five” from meeting or training. Our café + occasional tables help carry the design into your casual and touch-down spaces.



EFFECTIVE OCTOBER 17, 2022

1. Collaborative Hexagon

Category	Code	Quantity	Description	List Price	Ext Price
Tabletop	3271 TBT3 GR1 TPZ 3060 GP00	6	Trapezoidal Tabletop: 30" x 60", Grade 1 Laminate, No Grommets	\$600	\$3,600
Table Base	3272 TBT3C TPZ 3060 LS18	6	Fixed Top C-Leg Base, Glides	\$515	\$3,090
Ganging	3159 XGV	3	Pair of Ganging Brackets	\$50	\$150

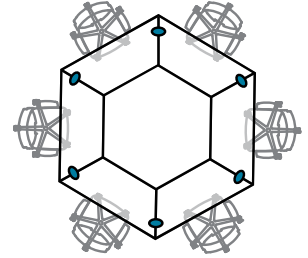

TOTAL: \$6,840

2. Small U-Shaped Training Space

Category	Code	Quantity	Description	List Price	Ext Price
Tabletop	3271 TBT3 GR1 TZ 3060 GP00	2	Rectangular Tabletop: 30" x 60", Grade 1 Laminate, No Grommets	\$385	\$770
Table Base	3272 TBT3 TZ 3060 TBT3C LS18	2	Fixed Top T-Leg Base, Glides (Pairs With 30" x 60" Rectangular Tabletop)	\$515	\$1,030
Tabletop	3271 TBT3 GR1 TPZ 3060 GP00	3	Trapezoidal Tabletop: 30" x 60", Grade 1 Laminate, No Grommets	\$600	\$1,800
Table Base	3272 TBT3 TPZ 3060 TBT3C LS18	3	Fixed Top T-Leg Base, Glides (Pairs With 30" x 60" Trapezoid Tabletop)	\$515	\$1,545
Ganging	3159 XGV	2	Pair of Ganging Brackets	\$50	\$100

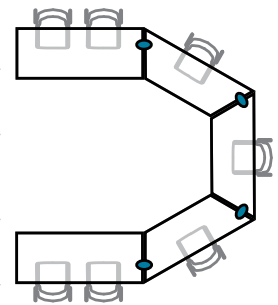

TOTAL: \$5,245

3. U-Shaped Training Space

Category	Code	Quantity	Description	List Price	Ext Price
Tabletop	3271 TBT2 GR1 TZ 3060 TE5 GP00	7	Rectangular Tabletop: 30" x 60", Grade 1 Laminate, No Grommets	\$385	\$2,695
Table Base	3260 TBT2 TZ 3072 LS18	7	Flip-Top T-Leg Base (Pairs With 30" x 60" Rectangular Tabletop)	\$723	\$5,061
Ganging	3159 XGV	6	Pair of Ganging Brackets	\$50	\$300

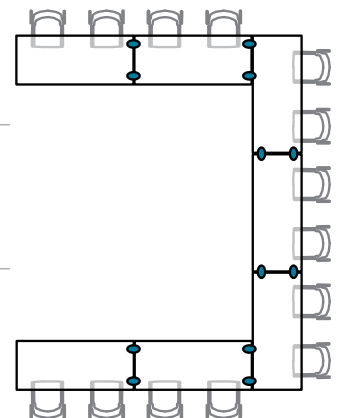

TOTAL: \$8,056

EFFECTIVE OCTOBER 17, 2022

4. Collaborative Trapezoid Workstation

Category	Code	Quantity	Description	List Price	Ext Price
Tabletop	3271 TBT3 GR1 TPZ 3060 TE5 GP00	8	Trapezoidal Tabletop: 30" x 60", Grade 1 Laminate, No Grommets	\$600	\$4,800
Table Base	3272 TBT3 TPZ 3060 TBT3C LS18	8	Fixed Top T-Leg Base, Casters Pairs With 30" x 60" Trapezoid Tabletop	\$515	\$4,120
Ganging	3159 XGV	4	Pair of Ganging Brackets	\$50	\$200
TOTAL:					\$9,120

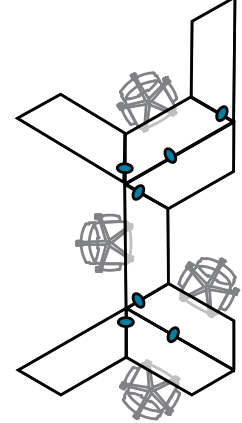

5. Classroom-Style, Individual Tables

Category	Code	Quantity	Description	List Price	Ext Price
Tabletop	3231 TBT2 GR2 TZ 3060 TE31 GP00	6	Rectangular Tabletop: 30" x 60", Grade 2 Laminate, Knife-Edged, No Grommets	\$694	\$4,164
Table Base	3272 TBT2 TZ 3060 LS18	6	Flip-Top T-Leg Base (Pairs With 30" x 60" Rectangular Tabletop)	\$723	\$4,338
TOTAL:					\$8,502

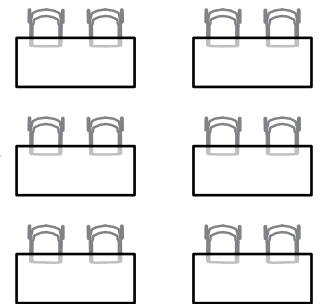

5. Classroom-Style, Rows

Category	Code	Quantity	Description	List Price	Ext Price
Tabletop	3271 TBT2 GR1 TZ 3060 TE5 GP00	6	Rectangular Tabletop: 30" x 60", Grade 1 Laminate, Flat-Edged No Grommets	\$385	\$2,310
Table Base	3272 TBT2C TZ 3060 LS18	6	Fixed-Top C-Leg Base, Casters (Pairs With 30" x 60" Half Round Tabletop)	\$515	\$3,090
Ganging	3159 XGV	4	Pair of Ganging Brackets	\$50	\$200
TOTAL:					\$5,600

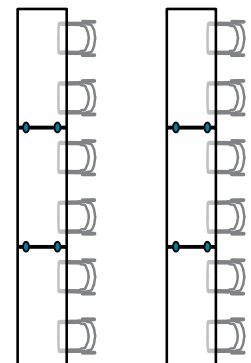

EFFECTIVE OCTOBER 17, 2022

6. Reconfigurable Conference Table

Category	Code	Quantity	Description	List Price	Ext Price
Tabletop	3231 TBT2 GR1 TZ 3060 TL27 GP00	6	Rectangular Tabletop: 30" x 60", Flat-Edged Laminate, No Grommets	\$385	\$2,310
Table Base	3272 TBT2 TZ 3060 LS18	6	Flip-Top T-Leg Base (Pairs With 30" x 60" Rectangular Tabletop)	\$515	\$3,090
Ganging	3159 XGV	5	Pair of Ganging Brackets	\$50	\$250
TOTAL:				\$5,650	

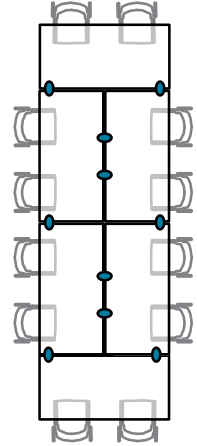

7. Impromptu Conference Table

Category	Code	Quantity	Description	List Price	Ext Price
Tabletop	3271 TBT3 GR1 TZ 3060 GP00	2	Rectangular Tabletop: 30" x 72", Grade 1 Laminate, No Grommets	\$450	\$900
Table Base	3272 TBT3 TZ 3060 TBT2 LS19	2	Fixed-Top T-Leg Base, Casters (Pairs With 30" x 72" Rectangular Tabletop)	\$515	\$1,030
Tabletop	3271 TBT3 GR1 THR 3060 GP00	2	Half-Round Tabletop: 30" x 60", Grade 1 Laminate, No Grommets	\$600	\$1,200
Table Base	3272 TBT3 TE5 THR 3060 LS19	2	Fixed-Top T-Leg Base, Casters (Pairs With 30" x 60" Half Round Tabletop)	\$515	\$1,030
Ganging	3159 XGV	3	Pair of Ganging Brackets	\$50	\$150
TOTAL:				\$4,310	

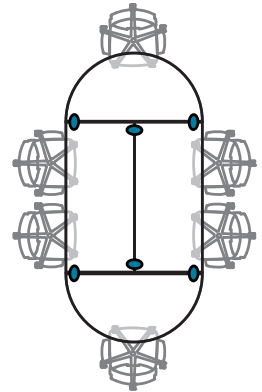

8. Collapsible Round

Category	Code	Quantity	Description	List Price	Ext Price
Tabletop	3271 TBT3 GR1 THR 3060 GP00	2	Half-Round Tabletop: 30" x 60", Grade 1 Laminate, No Grommets	\$600	\$1,200
Table Base	3272 TBT3 TE5 THR 3060 LS19	2	Flip-Top T-Leg Base, Casters (Pairs With 30" x 60" Half Round Tabletop)	\$723	\$1,446
Ganging	3159 XGV	1	Pair of Ganging Brackets	\$50	\$50
TOTAL:				\$2,696	

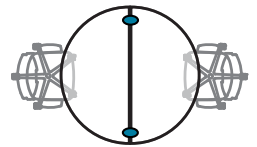

Parallon

FLIP-TOP AND FIXED TOP TRAINING TABLE

Everything to the table.

When you want cohesion in spaces large, small, shared or separate, there's Parallon. It's a single collection with a singular look, offering an array of choices for a variety of environments—and all the features to fit. Ensure design is never a distraction in the places where everyone needs to focus. Our Parallon line of training tables provides a unified and streamlined look from room to room.



30" x 60" Fixed Top
Chairs sold separately.
See [page 255](#) for *Movi*.

EFFECTIVE OCTOBER 17, 2022

Featured Models

30" x 60" T-LEG :: \$900

30" x 60" tabletop, grade 1 laminate,
fixed base, glides

30" x 60" C-LEG :: \$1,115

30" x 60" trapezoid tabletop, grade 1
laminate, C-leg fixed base, glides

30" x 60" FLIP-TOP :: \$1,108

30" x 60" rectangular tabletop,
grade 1 laminate, flip-top base, casters

Features

- A broad yet curated collection that's easy to specify across countless applications
- Developed entirely in-house (from the ground up) to make space cohesion effortless
- Training or collaboration—enjoy a variety of table types, tops, bases and more
- Soft-close flip-top models with quick-release latches can nest, store and deploy easily
- Powder-coated metal finishes in black, white or silver
- An array of 28 laminate options; 11 Grade 1 and 17 Grade 2
- 300 lb weight capacity warranty
- Exceeds BIFMA requirements for safety.

1. Product

Product Type	Code	Price
Tabletop	3271	Priced by Size
Table Base	Code	Price
Flip-Top, T-Leg	TBT2	Priced by Size
Fixed Top, T-Leg	TBT3	Priced by Size
Fixed Top, C-Leg	TBT3C	Priced by Size

2. Tabletop Finish

Laminate Color	Code	Price
Grade 1 Laminate		
Ankara Cherry	TL18	Priced by Size
Black	TL19	Priced by Size
Brazilian Walnut	TL20	Priced by Size
Cabinet Maple	TL21	Priced by Size
Driftwood	TL23	Priced by Size
Folkstone Grey	TL24	Priced by Size
Libretti	TL25	Priced by Size
Queenston Oak	TL26	Priced by Size
Sandalwood	TL27	Priced by Size
Walnut Amati	TL28	Priced by Size
White	TL29	Priced by Size

FLIP-TOP AND TRAINING TABLETOP TOPS AND BASES ARE SPECIFIED AND SOLD SEPARATELY.

2. Tabletop Finish

Laminate Color	Code	Price
Grade 2 (HPL) Laminates		
Classic Linen	TL17	Priced by Grade
Colombian Walnut	TL55	Priced by Grade
Crisp Linen	TL64	Priced by Grade
Designer White	TL66	Priced by Grade
Field Elm	TL13	Priced by Grade
Frosty White	TL16	Priced by Grade
Grey	TL62	Priced by Grade
Grey Elm	TL51	Priced by Grade
Kingswood Walnut	TL53	Priced by Grade
Manitoba	TL56	Priced by Grade
Neo Walnut	TL50	Priced by Grade
Platinum	TL61	Priced by Grade
Portico Teak	TL60	Priced by Grade
Skyline Walnut	TL15	Priced by Grade
Steel Mesh	TL59	Priced by Grade
Tuscan Walnut	TL57	Priced by Grade
Uptown Walnut	TL14	Priced by Grade
Laminate Grade	Code	Price
Grade 1	GR1	Priced by Size
Grade 2	GR2	Priced by Size

3. Shape

Tabletop Size	Code	Price
Rectangular Tabletop	TZ	Priced by Size
Half Round Tabletop	THR	Priced by Size
Trapezoid Tabletop	TPZ	Priced by Size

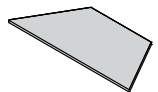
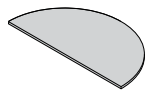
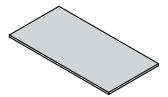

EFFECTIVE OCTOBER 17, 2022

4. Edge

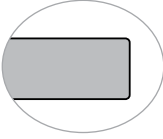
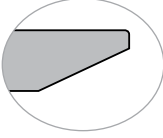
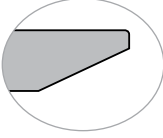
Edge Profile	Code	Price	
Flat Edge	TE5	Priced by Size	
Knife Edge, Front Only	TE31	Priced by Size	
Knife Edge, Front and Back	TE32	Priced by Size	

Knife edges are only available on grade 2 (GR2) laminate tabletops. Front and back knife edge option (TE5) is not available on half round (THR) tabletops.

5. Size

Tabletop Size	Code	Price		
Rectangular (D x W)		Grade 1 Flat Edge	Grade 2 Flat Edge	Grade 2 Knife Edge
18" x 42"	1842	\$176	\$264	\$317
18" x 48"	1848	\$200	\$300	\$360
18" x 54"	1854	\$225	\$338	\$406
18" x 60"	1860	\$248	\$372	\$447
18" x 66"	1866	\$275	\$413	\$496
18" x 72"	1872	\$300	\$450	\$540
24" x 42"	2442	\$229	\$344	\$413
24" x 48"	2448	\$261	\$392	\$471
24" x 54"	2454	\$292	\$438	\$526
24" x 60"	2460	\$324	\$486	\$584
24" x 66"	2466	\$358	\$537	\$645
24" x 72"	2472	\$389	\$584	\$701
30" x 42"	3042	\$285	\$428	\$514
30" x 48"	3048	\$324	\$486	\$584
30" x 54"	3054	\$366	\$549	\$659
30" x 60"	3060	\$385	\$578	\$694
30" x 66"	3066	\$445	\$668	\$802
30" x 72"	3072	\$450	\$675	\$810
36" x 42"	3642	\$540	\$810	\$972
36" x 48"	3648	\$570	\$855	\$1,026
36" x 54"	3654	\$625	\$938	\$1,126
36" x 60"	3660	\$700	\$1,050	\$1,260
36" x 66"	3666	\$790	\$1,185	\$1,422
36" x 72"	3672	\$800	\$1,200	\$1,440

FLIP-TOP AND TRAINING TABLETOP

TOPS AND BASES ARE SPECIFIED AND SOLD SEPARATELY.

5. Size (Cont.)

Tabletop Size	Code	Price		
Half Round		Grade 1 Flat Edge	Grade 2 Flat Edge	Grade 2 Knife Edge
24" x 48"	2448	\$340	\$510	\$612
30" x 60"	3060	\$600	\$900	\$1,080
Trapezoid		Grade 1 Flat Edge	Grade 2 Flat Edge	Grade 2 Knife Edge
24" x 48"	2448	\$340	\$510	\$612
30" x 60"	3060	\$600	\$900	\$1,080

36" (D) tabletops are not compatible with C-leg table bases.

6. Grommets

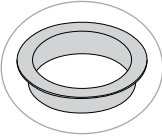
Grommet Location	Code	Price	
No Grommets	GP00	+ \$0	
Circular Grommets			
Left Only	GP01	+ \$30	
Center Only	GP02	+ \$30	
Right Only	GP03	+ \$30	
Left and Center	GP04	+ \$60	
Left and Right	GP05	+ \$60	
Right and Center	GP06	+ \$60	
Left, Right and Center	GP07	+ \$90	
Cutouts			
Precut for Parallon Power Accessory	GP08	+ \$30	
Grommet Color	Code	Price	
Black	GC01	+ \$0	
White	GC02	+ \$0	

Cutout option (GP08) is intended for use with a power unit. Corresponding grommet comes packaged with the power, which is sold separately. See [page 429](#) to purchase Parallon power accessories.

Circular grommets cannot be paired with power options.

EFFECTIVE OCTOBER 17, 2022

1. Product

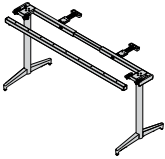
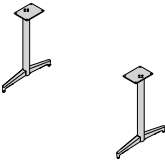
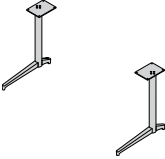
Product Type	Code	Price	
Table Base	3272	Priced by Base Style	
Base Style	Code	Price	
Flip-Top T	TBT2	\$723	
Fixed Top T	TBT3	\$515	
Fixed Top C	TBT3C	\$515	

2. Matching Tabletop

Tabletop Shape	Code	Price	
Half Round Tabletop	THR	+ \$0	
Rectangular Tabletop	TZ	+ \$0	
Trapezoid Tabletop	TPZ	+ \$0	

FLIP-TOP AND TRAINING TABLE BASE TOPS AND BASES ARE SPECIFIED AND SOLD SEPARATELY.

2. Matching Tabletop

Tabletop Size	Code	Price	
Rectangular			
18" x 42"	1842	+ \$0	
18" x 48"	1848	+ \$0	
18" x 54"	1854	+ \$0	
18" x 60"	1860	+ \$0	
18" x 66"	1866	+ \$0	
18" x 72"	1872	+ \$0	
24" x 42"	2442	+ \$0	
24" x 48"	2448	+ \$0	
24" x 54"	2454	+ \$0	
24" x 60"	2460	+ \$0	
24" x 66"	2466	+ \$0	
24" x 72"	2472	+ \$0	
30" x 42"	3042	+ \$0	
30" x 48"	3048	+ \$0	
30" x 54"	3054	+ \$0	
30" x 60"	3060	+ \$0	
30" x 66"	3066	+ \$0	
30" x 72"	3072	+ \$0	
36" x 42"	3642	+ \$0	
36" x 48"	3648	+ \$0	
36" x 54"	3654	+ \$0	
36" x 60"	3660	+ \$0	
36" x 66"	3666	+ \$0	
36" x 72"	3672	+ \$0	
Half Round			
24" x 48"	2448	+ \$0	
30" x 60"	3060	+ \$0	
Trapezoid			
24" x 48"	2448	+ \$0	
30" x 60"	3060	+ \$0	

C-leg bases are not compatible with 36" deep tabletops.

EFFECTIVE OCTOBER 17, 2022

3. Base Finish

Paint Color	Code	Price
Silver	BF01	+ \$0
White	BF02	+ \$0
Black	BF03	+ \$0

4. Feet

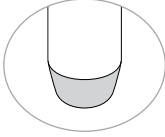
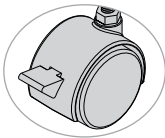
Foot Style	Code	Price	
Glides	LS18	+ \$0	
Casters	LS19	+ \$0	

Glide color will match base finish color. Casters (LS19) include two locking casters for the front feet and two non-locking casters for the back feet.



30" x 60" Flip-Top (Flipped and Nested)

FLIP-TOP AND TRAINING TABLE BASE

TOPS AND BASES ARE SPECIFIED AND SOLD SEPARATELY.

BASE SPECIFICATIONS

	Fixed T-Leg	Flip-Top T-Leg	Fixed C-Leg
Rectangular Tabletops			
18" x 42"	21.48 lb	30.92 lb	21.97 lb
18" x 48"	21.48 lb	36.04 lb	21.97 lb
18" x 54"	21.48 lb	36.69 lb	21.97 lb
18" x 60"	24.91 lb	37.54 lb	25.40 lb
18" x 66"	25.48 lb	38.19 lb	25.97 lb
18" x 72"	26.05 lb	39.04 lb	26.54 lb
24" x 42"	22.32 lb	31.98 lb	23.27 lb
24" x 48"	22.32 lb	37.10 lb	23.27 lb
24" x 54"	22.32 lb	37.75 lb	23.27 lb
24" x 60"	25.75 lb	38.60 lb	26.70 lb
24" x 66"	26.32 lb	39.25 lb	27.27 lb
24" x 72"	26.89 lb	40.10 lb	27.84 lb
30" x 42"	22.32 lb	32.12 lb	27.85 lb
30" x 48"	22.32 lb	37.24 lb	27.85 lb
30" x 54"	22.32 lb	37.89 lb	27.85 lb
30" x 60"	25.75 lb	38.74 lb	31.28 lb
30" x 66"	26.32 lb	39.39 lb	31.85 lb
30" x 72"	26.89 lb	40.24 lb	32.42 lb
36" x 42"	22.32 lb	32.12 lb	N/A
36" x 48"	22.32 lb	37.24 lb	N/A
36" x 54"	22.32 lb	37.89 lb	N/A
36" x 60"	25.75 lb	38.74 lb	N/A
36" x 66"	26.32 lb	39.39 lb	N/A
36" x 72"	26.89 lb	40.24 lb	N/A
Half Round Tabletops			
24" x 48"	21.48 lb	30.17 lb	21.97 lb
30" x 60"	22.32 lb	31.98 lb	23.27 lb
Trapezoid Tabletops			
24" x 48"	21.48 lb	29.42 lb	21.97 lb
30" x 60"	22.32 lb	31.23 lb	23.27 lb

See the Stand-Alone Tabletop appendix on page 588 for tabletop weights.

Features

- Daisy chain power and cable management will put a charge into any area
- Corded, hardwired daisy chain kit options: 5A/120V AC power receptacles and 2.1A/5V dual USB charging ports
- UL/ETL listed for US and Canada
- Hardwire power (4-circuit) for more demanding applications: 8 wire 4 circuit (3+1) system, single-sided quad power blocks, 4-15A/120V AC simplex receptacles, 4 data knockouts for RJ45 connectors -
- ETL listed for US and Canada.

1. Standalone Power Kit

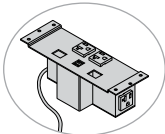
Product Type	Code	Price	
Standalone 3-Prong Infeed	3131 PV1 SA1	\$513	
Power Type	Code	Price	
2AC, Dual USB, 2 Data	PT8	+ \$0	
Power Color	Code	Price	
Silver	PC2	+ \$0	

ACCESSORIES AND POWER

EACH PRODUCT SOLD SEPARATELY.

1. Daisy Chain Power

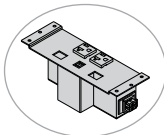
Daisy Chain Power Kit	Code	Price	
Single Quick Kit	3131 PV1 Q1	\$652	
Table Length	Code	Price	
48"	DL48	+ \$0	
60"	DL60	+ \$21	
72"	DL72	+ \$42	
Power Type	Code	Price	
2AC, Dual USB, 2 Data	PT8	+ \$0	
Power Color	Code	Price	
Silver	PC2	+ \$0	

2. Daisy Chain Power Infeed

Product Type	Code	Price	
Power Infeed	3131 PV1 IF	Priced by Style	
Product Style	Code	Price	
Hardwire, 72"	HWC72	+ \$160	
20-Amp, 3-Prong, 72"	TPC72	+ \$244	

Maximum of 9 tables per infeed.

EFFECTIVE OCTOBER 17, 2022

1. Hardwire Power

Power Style	Code	Price	
4-Circuit, Single Sided, Power and Data Ready	3132 PS1 SB1 PT7	\$369	
Power Color	Code	Price	
Black	PC1	+ \$0	

2. Hardwire Power Linking Cables

Linking Cables	Code	Price	
8-Wire, 4-Circuit Interconnect Cables	3132 PS1 IC	Priced by Style	
Length (IC Only)	Code	Price	
42" for 48" Tabletops	IC42	\$130	
54" for 60" Tabletops	IC54	\$167	
66" for 72" Tabletops	IC66	\$205	

3. Hardwire Power Infeed

Product Style	Code	Price	
Hardwire Power Infeed, 72"	3132 PS1 IF HWC72	\$221	

Maximum of 5 linked tables per circuit. Maximum of 20 linked tables if all 4 circuits are used.

1. Wire Management

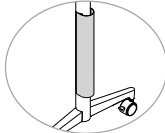
Product Type	Code	Price	
Vertical Wire Leg Cover	3279 WM07	\$56	
Paint Color	Code	Price	
Silver	WMC01	\$0	
White	WMC02	\$0	
Black	WMC03	\$0	

1. Other Accessories

Ganging	Code	Price	
Pair of Ganging Brackets	3159 XGV	\$50	

ACCESSORIES AND POWER

EACH PRODUCT SOLD SEPARATELY.

NUMBER OF GANGING BRACKET LOCATIONS

	Flat Edge	Knife Edge (Front Only)	Knife Edge (Front and Back)
T-Leg Flip-Top Rectangle			
18" (D) x 42"-66" (W)	10	6	2
18" (D) x 72" (W)	8	6	2
24" Deep	10	6	2
30" Deep	12	8	4
36" Deep	12	8	4
T-Leg Fixed-Top Rectangle			
18" Deep	12	8	4
24" Deep	10	6	2
30" Deep	12	8	4
36" Deep	12	8	4
C-Leg Fixed-Top Rectangle			
18" Deep	8	4	2
24" Deep	8	4	2
30" Deep	12	8	4
T-Leg Flip-Top Half Round			
24" Deep	6	4	4
30" Deep	6	4	4
T-Leg Fixed-Top Half Round			
24" Deep	6	4	4
30" Deep	6	4	4
C-Leg Fixed-Top Half Round			
24" Deep	6	4	4
30" Deep	6	4	4
T-Leg Flip-Top Trapezoid			
24" Deep	6	4	4
30" Deep	6	4	4
T-Leg Fixed-Top Trapezoid			
24" Deep	6	4	4
30" Deep	6	4	4
C-Leg Fixed-Top Trapezoid			
24" Deep	6	4	4
30" Deep	6	4	4

Parallon

MEETING, CAFÉ AND OCCASIONAL TABLE

Everything to the table.

When you want cohesion in spaces large, small, shared or separate, there's Parallon. It's a single collection with a singular look, offering an array of choices for a variety of environments—and all the features to fit. Continue the cohesion even when it's time to “take five” from meeting or training. Our café + occasional tables help carry the design into your casual and touch-down spaces.



Meeting Table
Chairs sold separately. See [page 251](#) for Hexy.

EFFECTIVE OCTOBER 17, 2022

Featured Models

MEETING :: \$1,868

36" x 72" rectangular laminate tabletop, dual disc base, 29" column height, grade 1 laminate

CAFÉ :: \$902

36" square laminate tabletop, grade 1 laminate, 42" column height, disc-base

OCCASIONAL :: \$557

24" round laminate tabletop, grade 1 laminate, 16" column height, x-base,

Features

- A broad yet curated collection that's easy to specify across countless applications
- Developed entirely in-house (from the ground up) to make space cohesion effortless
- Meeting, café or occasional—enjoy a variety of table types, tops, bases and more
- Five column height choices
- Powder-coated metal finishes in black, white or silver
- Universal built-in desktop power fits all outlet types, including AC, USB-A and USB-C
- An array of 28 laminate options; 11 Grade 1 and 17 Grade 2
- 300 lb weight capacity warranty
- Exceeds BIFMA requirements for safety

1. Product

Product Type	Code	Price
Tabletop	3271	Priced by Size
Pairs With	Code	Price
X-Base Café/Occasional	TBT4	Priced by Size
X-Base Power Ready	TBT4P	Priced by Size
Disc-Base	TBT15	Priced by Size
Disc Base Power Ready	TBT15P	Priced by Size
Dual Disc-Base	TBT16	Priced by Size
Dual Disc Base Power Ready	TBT16P	Priced by Size

2. Tabletop Finish

Laminate Color	Code	Price
Grade 1 Laminate		
Ankara Cherry	TL18	Priced by Grade
Black	TL19	Priced by Grade
Brazilian Walnut	TL20	Priced by Grade
Cabinet Maple	TL21	Priced by Grade
Driftwood	TL23	Priced by Grade
Folkstone Grey	TL24	Priced by Grade
Libretti	TL25	Priced by Grade
Queenston Oak	TL26	Priced by Grade
Sandalwood	TL27	Priced by Grade
Walnut Amati	TL28	Priced by Grade
White	TL29	Priced by Grade
Grade 2 Laminate		
Classic Linen	TL17	Priced by Grade
Colombian Walnut	TL55	Priced by Grade
Crisp Linen	TL64	Priced by Grade
Designer White	TL66	Priced by Grade
Field Elm	TL13	Priced by Grade
Frosty White	TL16	Priced by Grade
Grey	TL62	Priced by Grade
Grey Elm	TL51	Priced by Grade
Kingswood Walnut	TL53	Priced by Grade
Manitoba	TL56	Priced by Grade
Neo Walnut	TL50	Priced by Grade
Platinum	TL61	Priced by Grade
Portico Teak	TL60	Priced by Grade
Skyline Walnut	TL15	Priced by Grade
Steel Mesh	TL59	Priced by Grade
Tuscan Walnut	TL57	Priced by Grade
Uptown Walnut	TL14	Priced by Grade
Laminate Grade	Code	Price
Laminate Grade 1	GR1	Priced by Size
Laminate Grade 2	GR2	Priced by Size

3. Shape

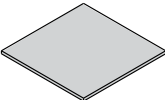
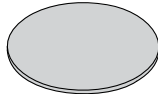
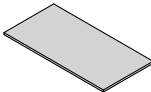
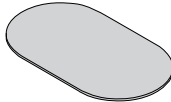
Tabletop Shape	Code	Price	
Square	TS	Priced by Size	
Round	TR	Priced by Size	
Rectangular	TZ	Priced by Size	
Racetrack	TK	Priced by Size	

Actual size of 30" x 30" tabletop is 30.75" x 30.75".

4. Edge

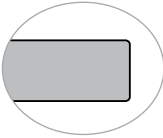
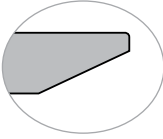
Edge Profile	Code	Price	
Flat Edge	TE5	+ \$0	
Knife Edge, All Sides	TE3	+ \$0	

Knife edges are only available on grade 2 (GR2) laminate tabletops.

5. Size

Tabletop Size	Code	Laminate Price		
Occasional and Café (Square or Round)		Grade 1 Flat Edge	Grade 2 Flat Edge	Grade 2 Knife Edge
24"	2424	\$274	\$411	\$494
30"	3030	\$297	\$446	\$536
36"	3636	\$345	\$518	\$622
42"	4242	\$385	\$578	\$694
48"	4848	\$458	\$687	\$825
54"	5454	\$800	\$1,200	\$1,440
60"	6060	\$1,200	\$1,800	\$2,160
Meeting (Rectangular or Racetrack)		Grade 1 Flat Edge	Grade 2 Flat Edge	Grade 2 Knife Edge
24" x 60"	2460	\$324	\$486	\$584
30" x 72"	3072	\$450	\$675	\$810
30" x 84"	3084	\$565	\$848	\$1,018
30" x 96"	3096	\$850	\$1,275	\$1,530
36" x 72"	3672	\$800	\$1,200	\$1,440
36" x 84"	3684	\$875	\$1,313	\$1,576
36" x 96"	3696	\$950	\$1,425	\$1,710

Actual size of 30" x 30" tabletop is 30.75" x 30.75".

Disc base is not available with 54" and 60" tabletops. 16", 20", and 42" tall columns are not compatible with 54" and 60" tabletops.

6. Edge

Grommet/Power Location (Power-Ready Models Only)	Code	Price	
Round and Square Tabletop			
Center Only	TE5	+ \$30	
Racetrack and Rectangular Tabletop			
Left Only	TE5	+ \$30	
Right Only	TE5	+ \$30	
Left and Right	TE5	+ \$60	

1. Product

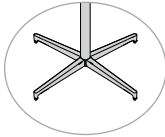
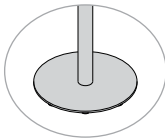
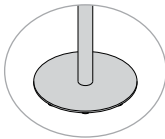
Product Type	Code	Price	
Table Base	3272	Priced by Column Height	
Base Style	Code	Price	
Round and Square Tabletops			
X-Base	TBT4	\$356	
X-Base Power Ready	TBT4P	\$496	
Disc-Base	TBT15	\$534	
Disc Base Power Ready	TBT15P	\$674	
Racetrack and Rectangular Tabletops			
Dual Disc-Base	TBT16	\$1068	
Dual Disc Base Power Ready	TBT16P	\$1,348	

Power module (PT111) must be ordered separately.

2. Base Finish

Paint Color	Code	Price	
Silver	BF01	+ \$0	
White	BF02	+ \$0	
Black	BF03	+ \$0	

3. Power

Standalone Power Unit	Code	Price	
1AC-1USBA-1USBC Outlet With 8 Foot Cable	PT111	+ \$335	
Power Color	Code	Price	
Black	PC1	+ \$0	
White	PC4	+ \$0	

MEETING, CAFÉ AND OCCASIONAL TABLETOP TOPS AND BASES ARE SPECIFIED AND SOLD SEPARATELY.

4. Matching Tabletop

Table Top Size	Code	Price	
Occasional and Café (Square or Round)			
24"	2424	+ \$0	
30"	3030	+ \$0	
36"	3636	+ \$0	
42"	4242	+ \$0	
48"	4848	+ \$0	
54"	5454	+ \$0	
60"	6060	+ \$0	
Meeting (Rectangular or Racetrack)			
24" x 60"	2460	+ \$0	
30" x 72"	3072	+ \$0	
30" x 84"	3084	+ \$0	
30" x 96"	3096	+ \$0	
36" x 72"	3672	+ \$0	
36" x 84"	3684	+ \$0	
36" x 96"	3696	+ \$0	

Table bases require the specification of a tabletop size. Bases take their size from their corresponding top size.

Disc base is not available with 54" and 60" tabletops. 16", 20" and 42" height columns are not compatible with 54" and 60" tabletops.

5. Height

Column Height	Code	Price	
Occasional (Square or Round)			
16"	TH16	- \$53	
20"	TH20	- \$43	
Café (Square or Round)			
29"	TH29	+ \$0	
36"	TH36	+ \$11	
42"	TH42	+ \$23	
Meeting (Rectangular or Racetrack)			
29"	TH29	+ \$0	
36"	TH36	+ \$22	
42"	TH42	+ \$46	

6. Feet

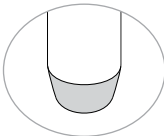
Foot Style	Code	Price	
Glides	LS18	+ \$0	

Glide color will match base finish color.

SPECIFICATIONS: WEIGHT

Table Depth	X-Base	Disc-Base
Square Tabletop		
24" x 16" (H)	15.35 lb	78.25 lb
24" x 20" (H)	16.25 lb	79.47 lb
24" x 29" (H)	18.26 lb	80.95 lb
24" x 36" (H)	19.85 lb	84.33 lb
24" x 42" (H)	21.20 lb	84.90 lb
30" x 16" (H)	17.95 lb	78.25 lb
30" x 20" (H)	18.85 lb	79.47 lb
30" x 29" (H)	20.86 lb	80.95 lb
30" x 36" (H)	22.45 lb	84.33 lb
30" x 42" (H)	23.80 lb	84.90 lb
36" x 16" (H)	17.95 lb	78.25 lb
36" x 20" (H)	18.85 lb	79.47 lb
36" x 29" (H)	20.86 lb	80.95 lb
36" x 36" (H)	22.45 lb	84.33 lb
36" x 42" (H)	23.80 lb	84.90 lb
42" x 16" (H)	19.19 lb	78.25 lb
42" x 20" (H)	20.09 lb	79.47 lb
42" x 29" (H)	22.10 lb	80.95 lb
42" x 36" (H)	23.69 lb	84.33 lb
42" x 42" (H)	25.04 lb	84.90 lb
48" x 16" (H)	19.19 lb	78.25 lb
48" x 20" (H)	20.09 lb	79.47 lb
48" x 29" (H)	22.10 lb	80.95 lb
48" x 36" (H)	23.69 lb	84.33 lb
48" x 42" (H)	25.04 lb	84.90 lb
54" x 29" (H)	22.10 lb	80.95 lb
54" x 36" (H)	23.69 lb	84.33 lb
60" x 29" (H)	22.10 lb	80.95 lb
60" x 36" (H)	23.69 lb	84.33 lb
Round Tabletop		
24" x 16" (H)	15.35 lb	52.92 lb
24" x 20" (H)	16.25 lb	54.14 lb
24" x 29" (H)	18.26 lb	55.62 lb
24" x 36" (H)	19.85 lb	59 lb
24" x 42" (H)	21.2 lb	59.57 lb
30" x 16" (H)	15.35 lb	52.92 lb
30" x 20" (H)	16.25 lb	54.14 lb
30" x 29" (H)	18.26 lb	55.62 lb
30" x 36" (H)	19.85 lb	59 lb
30" x 42" (H)	21.2 lb	59.57 lb
36" x 16" (H)	17.95 lb	52.92 lb
36" x 20" (H)	18.85 lb	54.14 lb
36" x 29" (H)	20.86 lb	55.62 lb
36" x 36" (H)	22.45 lb	59 lb
36" x 42" (H)	23.8 lb	59.57 lb
42" x 16" (H)	19.19 lb	52.92 lb
42" x 20" (H)	20.09 lb	54.14 lb
42" x 29" (H)	22.1 lb	55.62 lb
42" x 36" (H)	23.69 lb	59 lb
42" x 42" (H)	25.04 lb	59.57 lb
48" x 16" (H)	19.19 lb	52.92 lb
48" x 20" (H)	20.09 lb	54.14 lb
48" x 29" (H)	22.1 lb	55.62 lb
48" x 36" (H)	23.69 lb	59 lb
48" x 42" (H)	25.04 lb	59.57 lb
54" x 29" (H)	22.1 lb	55.62 lb
54" x 36" (H)	23.69 lb	59 lb
60" x 29" (H)	22.1 lb	55.62 lb
60" x 36" (H)	23.69 lb	59 lb

MEETING, CAFÉ AND OCCASIONAL TABLETOP TOPS AND BASES ARE SPECIFIED AND SOLD SEPARATELY.

SPECIFICATIONS: WEIGHT

Table Depth	Disc-Base
Rectangular Tabletop	
24" x 29" (H)	161.90 lb
24" x 36" (H)	168.66 lb
24" x 42" (H)	169.80 lb
30" x 29" (H)	161.90 lb
30" x 36" (H)	168.66 lb
30" x 42" (H)	169.80 lb
36" x 29" (H)	161.90 lb
36" x 36" (H)	168.66 lb
36" x 42" (H)	169.80 lb
Racetrack Tabletop	
24" x 29" (H)	111.24 lb
24" x 36" (H)	118.00 lb
24" x 42" (H)	119.14 lb
30" x 29" (H)	111.24 lb
30" x 36" (H)	118.00 lb
30" x 42" (H)	119.14 lb
36" x 29" (H)	111.24 lb
36" x 36" (H)	118.00 lb
36" x 42" (H)	119.14 lb

See the Stand-Alone Tabletop appendix on page 588 for tabletop weights.

SPECIFICATIONS: DIMENSIONS

Table Depth	X-Base	Disc-Base	Dual Disc
	Diagonal Footprint	Base Diameter	Base Diameter
24"	22.58"	21.00"	21.00"
30"	22.58"	21.00"	21.00"
36"	34.08"	21.00"	21.00"
42"	38.08"	27.00"	
48"	38.08"	27.00"	
54"	38.08"		
60"	38.08"		
	Column Diameter		
	2.25"	3"	3"
	Disc Base Thickness		
		0.39"	

Surge

2-LEG HEIGHT-ADJUSTABLE TABLE

Well-made wellness.

Add elevated design and sound ergonomics to any workspace with our Surge height-adjustable table. Its rugged dual-beam base is one of the quickest to assemble in the industry and can take on extra weight, giving you more tabletop options — all while providing peace of mind with enhanced safety features, including meeting BIFMA X5.5 standards.



EFFECTIVE OCTOBER 17, 2022

Featured Models

2-STAGE T-LEG :: \$1,108

2-Stage T-leg base, 24" x 60" laminate top, grade 1 laminate, no grommets, glides

2-STAGE T-LEG :: \$1,188

2-Stage T-leg base, 30" x 60" laminate top, grade 1 laminate, no grommets, glides

Features

- Support healthy working postures, whether seated or standing
- Surge offers a height range of 26.9"–46.6" (excluding top)
- Weight capacity warranty, including worksurface: Rated load is 250 lb at 10,000 cycles; maximum load is 265 lb
- Quick installation features an enhanced and exclusive locking mechanism
- Advanced anti-collision Sensor stops (and retracts) the table upon contact with any objects
- LED height display and push-button controls offer three user-customizable positions
- Available with T-leg and C-leg on adjustable glides
- 28 different durable laminate options to fit your style
- Three durable powder-coated metal finishes in silver, black or white
- Adjustment speed: 1.4 inches per second
- Operational noise level: approximately 48 dB (not including ambient noise)
- UL Certified and meets BIFMA X5.5 Certification

SPECIFICATIONS

Model:	3301/3302 TBT6/TBT6C
Dimensions	
Min and Max Height (Base Only)	26.9"–46.6"
Min and Max Height (With Table Top)	28"–47.7"
Foot Length With 23", 24" Tabletop Depth	22.72"
Foot Length With 29", 30" Tabletop Depth	28.62"
Tabletop Thickness	1.125"
Adjustment Speed	1.4 Inches Per Second
Number of Crossbar	2
Standby Power Consumption	2.6W
Noise	Approximately 48 DB (Not Including Ambient Noise)
Power Cord Lengths	106"
Rated Load Weight Capacity Warranty (Incl. Worksurface)	250 lb at 10,000 Cycles
Maximum Load Capacity (Incl. Worksurface)	265 lb

1. Tabletop

Product Type	Code	Price
Height-Adjustable Table	3301	Priced by Size
Product Style	Code	Price
2-Stage T-Leg Base	TBT6	Priced by Size
2-Stage C-Leg Base	TBT6C	Priced by Size
Laminate	Code	Price
Grade 1		
Ankara Cherry	TL18	Priced by Size
Black	TL19	Priced by Size
Brazilian Walnut	TL20	Priced by Size
Cabinet Maple	TL21	Priced by Size
Driftwood	TL23	Priced by Size
Folkstone Grey	TL24	Priced by Size
Libretti	TL25	Priced by Size
Queenston Oak	TL26	Priced by Size
Sandalwood	TL27	Priced by Size
Walnut Amati	TL28	Priced by Size
White	TL29	Priced by Size
Laminate	Code	Price
Grade 2		
Classic Linen	TL17	Priced by Size
Colombian Walnut	TL55	Priced by Size
Crisp Linen	TL64	Priced by Size
Designer White	TL66	Priced by Size
Field Elm	TL13	Priced by Size
Frosty White	TL16	Priced by Size
Grey	TL62	Priced by Size
Grey Elm	TL51	Priced by Size
Kingswood Walnut	TL53	Priced by Size
Manitoba	TL56	Priced by Size
Neo Walnut	TL50	Priced by Size
Platinum	TL61	Priced by Size
Portico Teak	TL60	Priced by Size
Skyline Walnut	TL15	Priced by Size
Steel Mesh	TL59	Priced by Size
Tuscan Walnut	TL57	Priced by Size
Uptown Walnut	TL14	Priced by Size
Laminate Grade	Code	Price
Laminate Grade 1	GR1	Priced by Size
Laminate Grade 2	GR2	Priced by Size

1. Tabletop (Cont.)

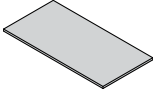
Tabletop Shape	Code	Price	
Rectangular	TZ	Priced by Size	

Tabletop Size	Code	Laminate Price	
		Grade 1	Grade 2
Rectangular (D x W)			
23" x 46"	TZ2346	\$261	\$392
23" x 52"	TZ2352	\$292	\$438
23" x 58"	TZ2358	\$324	\$486
23" x 64"	TZ2364	\$358	\$537
23" x 70"	TZ2370	\$389	\$584
23" x 76"	TZ2376	\$421	\$632
23" x 82"	TZ2382	\$453	\$680
24" x 42"	TZ2442	\$229	\$344
24" x 48"	TZ2448	\$261	\$392
24" x 54"	TZ2454	\$292	\$438
24" x 60"	TZ2460	\$324	\$486
24" x 66"	TZ2466	\$358	\$537
24" x 72"	TZ2472	\$389	\$584
24" x 78"	TZ2478	\$421	\$632
24" x 84"	TZ2484	\$453	\$680
29" x 46"	TZ2946	\$324	\$486
29" x 52"	TZ2952	\$366	\$549
29" x 58"	TZ2958	\$404	\$606
29" x 64"	TZ2964	\$445	\$668
29" x 70"	TZ2970	\$484	\$726
29" x 76"	TZ2976	\$526	\$789
29" x 82"	TZ2982	\$565	\$848
30" x 42"	TZ3042	\$285	\$428
30" x 48"	TZ3048	\$324	\$486
30" x 54"	TZ3054	\$366	\$549
30" x 60"	TZ3060	\$404	\$606
30" x 66"	TZ3066	\$445	\$668
30" x 72"	TZ3072	\$484	\$726
30" x 78"	TZ3078	\$526	\$789
30" x 84"	TZ3084	\$565	\$848

TABLE TOP

1. Tabletop (Cont.)

Grommet Location	Code	Price	
None	GP00	+ \$0	
Left	GP01	+ \$30	
Center	GP02	+ \$30	
Right	GP03	+ \$30	
Left and Center	GP04	+ \$60	
Left and Right	GP05	+ \$60	
Right and Center	GP06	+ \$60	
Left, Right and Center	GP07	+ \$90	

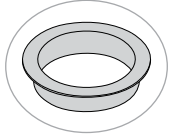

Grommet Color	Code	Price	
Black	GC01	+ \$0	
White	GC02	+ \$0	

Pilot Holes	Code	Price	
No Pre-Drilling for Accessories	BNDL00	+ \$0	

EFFECTIVE OCTOBER 17, 2022

1. Base

Product Type	Code	Price	
2-Leg Base	3302	Priced by Style	
Base Style	Code	Price	
2-Stage T-Leg Base	TBT6	\$784	
2-Stage C-Leg Base	TBT6C	\$784	

TABLE BASE

2. Matching Tabletop

Tabletop Shape	Code	Price	
Rectangular	TZ	Priced by Style	
Tabletop Size	Code	Price	
23" x 46"	TZ2346	+ \$0	+ \$0
23" x 52"	TZ2352	+ \$0	+ \$0
23" x 58"	TZ2358	+ \$0	+ \$0
23" x 64"	TZ2364	+ \$0	+ \$0
23" x 70"	TZ2370	+ \$0	+ \$0
23" x 76"	TZ2376	+ \$0	+ \$0
23" x 82"	TZ2382	+ \$0	+ \$0
24" x 42"	TZ2442	+ \$0	+ \$0
24" x 48"	TZ2448	+ \$0	+ \$0
24" x 54"	TZ2454	+ \$0	+ \$0
24" x 60"	TZ2460	+ \$0	+ \$0
24" x 66"	TZ2466	+ \$0	+ \$0
24" x 72"	TZ2472	+ \$0	+ \$0
24" x 78"	TZ2478	+ \$0	+ \$0
24" x 84"	TZ2484	+ \$0	+ \$0
29" x 46"	TZ2946	+ \$0	+ \$0
29" x 52"	TZ2952	+ \$0	+ \$0
29" x 58"	TZ2958	+ \$0	+ \$0
29" x 64"	TZ2964	+ \$0	+ \$0
29" x 70"	TZ2970	+ \$0	+ \$0
29" x 76"	TZ2976	+ \$0	+ \$0
29" x 82"	TZ2982	+ \$0	+ \$0
30" x 42"	TZ3042	+ \$0	+ \$0
30" x 48"	TZ3048	+ \$0	+ \$0
30" x 54"	TZ3054	+ \$0	+ \$0
30" x 60"	TZ3060	+ \$0	+ \$0
30" x 66"	TZ3066	+ \$0	+ \$0
30" x 72"	TZ3072	+ \$0	+ \$0
30" x 78"	TZ3078	+ \$0	+ \$0
30" x 84"	TZ3084	+ \$0	+ \$0

Switchback

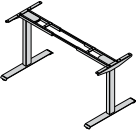
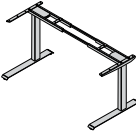
2-LEG HEIGHT-ADJUSTABLE TABLE BUNDLE

Find your fit.

Create a smarter workplace solution with Switchback, our number one height-adjustable table. Known for its class-leading anti-collision technology, compact shipping size and instant installation, it's the go-to for a dynamic workspace—and it gets even better when you bundle it with screens, power modules and keyboard trays for a complete, multifunctional workstation.



EFFECTIVE OCTOBER 17, 2022

Featured Models

ALL-IN-ONE :: \$4,791

2-leg 3-stage base, fixed glides, 24" x 60" pre-drilled rectangular tabletop, no grommets, height-adjustable screen mount, 30" x 60" fabric screen, Cable Caddy basket with power strip, laptop tray with HAT mechanism and U-brackets for crossrails, mini platform keyboard tray with mini trackless mechanism, half moon pencil drawer, Current clamp mount power module, Unity G2 single screen monitor arm, mobile pedestal with upholstered pad

Features

- The bundle can be built with any of Switchback's 2-leg models
- Switchback has three available base finishes and eleven tabletop finishes to fit your style
- Bundles have easy specification and installation; order together and the pilot holes for the accessories will be predrilled and ready to go
- Multiple monitor arm choices, including heavy duty options that support up to 33 lb
- Wire management and power module options to keep all of your electronics organized and powered on

1. Switchback Tabletop

Product Type	Code	Price
Tabletop	3161	Priced by Size
Product Style	Code	Price
2-Stage T-Leg Base	TBT6	Priced by Size
3-Stage T-Leg Base	TBT7	Priced by Size
2-Stage C-Leg Base	TBT6C	Priced by Size
3-Stage, C-Leg Base	TBT7C	Priced by Size
Laminate	Code	Price
Grade 1		
Ankara Cherry	TL18	Priced by Size
Black	TL19	Priced by Size
Brazilian Walnut	TL20	Priced by Size
Cabinet Maple	TL21	Priced by Size
Driftwood	TL23	Priced by Size
Folkstone Grey	TL24	Priced by Size
Libretti	TL25	Priced by Size
Queenston Oak	TL26	Priced by Size
Sandalwood	TL27	Priced by Size
Walnut Amati	TL28	Priced by Size
White	TL29	Priced by Size

SWITCHBACK BUNDLE

1. Switchback Tabletop (Cont.)

Laminate	Code	Price
Grade 2		
Classic Linen	TL17	Priced by Size
Colombian Walnut	TL55	Priced by Size
Crisp Linen	TL64	Priced by Size
Designer White	TL66	Priced by Size
Field Elm	TL13	Priced by Size
Frosty White	TL16	Priced by Size
Grey	TL62	Priced by Size
Grey Elm	TL51	Priced by Size
Kingswood Walnut	TL53	Priced by Size
Manitoba	TL56	Priced by Size
Neo Walnut	TL50	Priced by Size
Platinum	TL61	Priced by Size
Portico Teak	TL60	Priced by Size
Skyline Walnut	TL15	Priced by Size
Steel Mesh	TL59	Priced by Size
Tuscan Walnut	TL57	Priced by Size
Uptown Walnut	TL14	Priced by Size

Laminate Grade	Code	Price
Laminate Grade 1	GR1	Priced by Size
Laminate Grade 2	GR2	Priced by Size
Tabletop Shape	Code	Price

Rectangular TZ Priced by Size

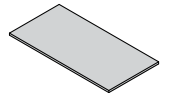

Tabletop Size	Code	Laminate Price	
Rectangular (D x W)		Grade 1	Grade 2
		24" x 60"	2460
24" x 66"	2466	\$358	\$537
24" x 72"	2472	\$389	\$584
30" x 60"	3060	\$404	\$606
30" x 66"	3066	\$445	\$668
30" x 72"	3072	\$484	\$726

SWITCHBACK

EFFECTIVE OCTOBER 17, 2022

1. Switchback Tabletop (Cont.)

Grommet Location	Code	Price
None	GP00	+ \$0
Left	GP01	+ \$30
Center	GP02	+ \$30
Right	GP03	+ \$30
Left and Center	GP04	+ \$60
Left and Right	GP05	+ \$60
Right and Center	GP06	+ \$60
Left, Right and Center	GP07	+ \$90

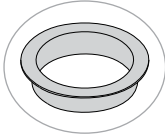

Grommet Color	Code	Price
Black	GC01	+ \$0
White	GC02	+ \$0

Pilot Holes	Code	Price
Pre-Drilled for Accessories	BNDL01	+ \$0

2. Switchback 2-Leg Base

Product Type	Code	Price
2-Leg Base	3162	Priced by Style

Base Style	Code	Price
2-Stage T-Leg Base	TBT6	\$874
3-Stage T-Leg Base	TBT7	\$1,005
2-Stage C-Leg Base	TBT6C	\$874
3-Stage C-Leg Base	TBT7C	\$1,005

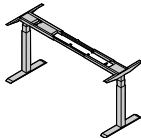
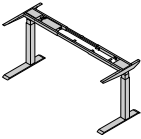
Matching Tabletop Shape	Code	Price
Rectangular	TZ	Priced by Style

Matching Tabletop Size (D x W)	Code	Price
24" x 60"	2460	Priced by Style
24" x 66"	2466	Priced by Style
24" x 72"	2472	Priced by Style
30" x 60"	3060	Priced by Style
30" x 66"	3066	Priced by Style
30" x 72"	3072	Priced by Style

Paint Color	Code	Price
Silver	BF01	+ \$0
White	BF02	+ \$0
Black	BF03	+ \$0

SWITCHBACK BUNDLE

2. Switchback 2-Leg Base (Cont.)

Foot Style	Code	Price
Glides	LS18	+ \$0
Casters	LS19	+ \$109

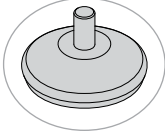
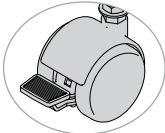
3. Screens

Product Type	Code	Price
Screen	3163	Priced by Size

Screen Material	Code	Price
Frosted Acrylic	DT101	+ \$0
Fabric	DT701	+ \$0
Markerboard	DT301	+ \$0

Screen Size	Code	Price
Frosted Acrylic		
24" x 60"	DS2460	\$569
24" x 66"	DS2466	\$625
24" x 72"	DS2472	\$683
30" x 60"	DS3060	\$711
30" x 66"	DS3066	\$781
30" x 72"	DS3072	\$851
Fabric		
24" x 60"	DS2460	\$593
24" x 66"	DS2466	\$657
24" x 72"	DS2472	\$731
30" x 60"	DS3060	\$717
30" x 66"	DS3066	\$738
30" x 72"	DS3072	\$757
Markerboard		
24" x 60"	DS2460	\$525
24" x 66"	DS2466	\$577
24" x 72"	DS2472	\$629
30" x 60"	DS3060	\$635
30" x 66"	DS3066	\$697
30" x 72"	DS3072	\$761

SWITCHBACK

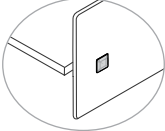
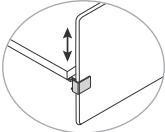

EFFECTIVE OCTOBER 17, 2022

3. Screens (Cont.)

Mount Style	Code	Price	
Midway	MT5	+ \$76	
Height-Adjustable	MT6	+ \$80	

Height-adjustable mount only available with 30" x 60" screen.

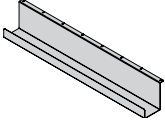
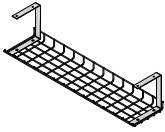
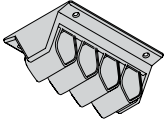
4. Wire Management

Product Type	Code	Price	
Cable Caddy	3152 WM03	\$178	
Cable Caddy Basket	3152 WM05	\$98	
Cable Caddy Clips	3152 WM01	\$82	
Cable Caddy Slim	3152 WM02	\$64	

5. Power Strip

Product Type	Code	Price	
Power Strip	3130 PST1 WM00	\$218	

SWITCHBACK BUNDLE

6. Laptop Tray

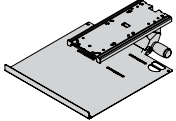
Product Type	Code	Price	
Laptop Tray	3154	Priced by Style	
Mechanism Style	Code	Price	
HAT	KBM01	\$154	
Platform Style	Code	Price	
Laptop Tray	KBP01	+ \$157	
Brackets	Code	Price	
U-Brackets for Crossrails	KBTA	+ \$114	

7. Keyboard Tray

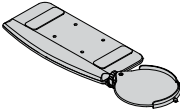
Product Type	Code	Price	
Keyboard Tray	3151	Priced by Style	
Mechanism Style	Code	Price	
Mini Trackless	KBM04	\$330	
Platform Style	Code	Price	
Mini Platform	KBP03	+ \$327	

8. Pencil Storage

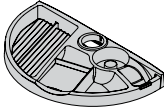
Product Type	Code	Price	
Half Moon	3155 PDT02	\$125	



SWITCHBACK

EFFECTIVE OCTOBER 17, 2022

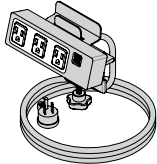
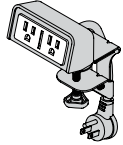
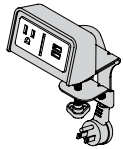
9. Power Module

Product Type	Code	Price	
Power	3130	Priced by Style	
Product Style	Code	Price	
Current With Clamp Mount	PCC	\$278	
EON Clamp On, Dual Outlet	PTC PT5	\$128	
EON Clamp On, Single Outlet, Dual USB	PTC PT2	\$185	
Power Color	Code	Price	
White	PC4	+ \$0	
Black	PC1	+ \$0	

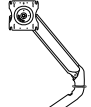
10. Monitor Arm

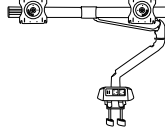
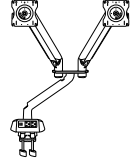
Product Type	Code	Price	
King Cobra Monitor Arm	3101	Priced by Style	
Unity G2 Monitor Arm	3111	Priced by Style	
Mobio Monitor Arm	3210	Priced by Style	
Product Style	Code	Price	
King Cobra			
Single Screen Light Duty	MAT01	\$729	
Single Screen Heavy Duty	MAT02	\$765	
Dual Screen Array Heavy Duty	MAT03	\$852	
Dual Screen High-Splitter Heavy Duty	MAT04	\$1,063	

SWITCHBACK BUNDLE

10. Monitor Arm (Cont.)

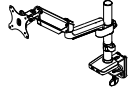
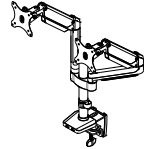
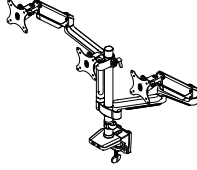
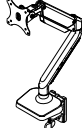
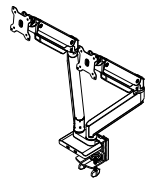
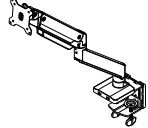
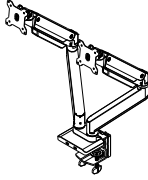
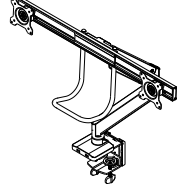
Product Style	Code	Price	
Mobio			
Single Pole	MAT30	\$387	
Dual Pole	MAT31	\$696	
Triple Pole	MAT32	\$807	
Single Desk	MAT33	\$303	
Dual Desk	MAT34	\$605	
Heavy Duty Single Desk	MAT35	\$473	
Heavy Duty Dual Desk	MAT36	\$1,060	
Heavy Duty Dual Array	MAT37	\$702	

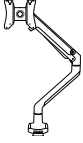
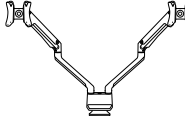

EFFECTIVE OCTOBER 17, 2022

10. Monitor Arm (Cont.)

Product Style	Code	Price	
Unity G2			
Single Monitor Arm	MAT06	\$356	
Dual Monitor Arm	MAT07	\$707	
Paint Color	Code	Price	
Black	MAC03	+ \$0	
Silver	MAC01	+ \$0	
White	MAC02	+ \$0	

King Cobra and Mobio HD monitor arms are available in silver only. Black finish available on Mobio monitor arms only (not available on heavy duty models).

11. Mobile Pedestal

Product Type	Code	Price	
Mobile Pedestal	3150	\$364	
Product Style	Code	Price	
No Upholstered Pad	CPT00	+ \$0	
Upholstered Pad	CPT01	+ \$144	
Paint Color	Code	Price	
Silver	PDC01	+ \$0	
White	PDC02	+ \$0	
Fabric Grade (CPT01 Only)	Code	Price	
Fabric/Vinyl Grade 1	FG1/VG1	+ \$0	
Fabric/Vinyl Grade 2	FG2/VG2	+ \$11	
Fabric/Vinyl Grade 3	FG3/VG3	+ \$30	
Fabric/Vinyl Grade 4	FG4/VG4	+ \$52	
Fabric/Vinyl Grade 5	FG5/VG5	+ \$90	
Fabric/Vinyl Grade 6	FG6/VG6	+ \$127	
Fabric/Vinyl Grade 7	FG7/VG7	+ \$165	

Please reference the [Textile Reference Guide](#) for pricing on fabric over grade 7.

Switchback

2-LEG HEIGHT-ADJUSTABLE TABLE

Find your fit.

Achieving the perfect position maximizes ergonomics and minimizes fatigue or injury. With the press of a button, you can make Switchback height-adjustable table elevate the way you work while ensuring it matches your unique needs. Configure your Switchback with a variety of leg options and an extensive portfolio of tabletop shapes and workstation add-ons. All that and quick installation make Switchback a leading solution in simplicity and endless versatility.



3-Stage T-Leg

Chair sold separately; see [page 69](#) for Focus 2.0

EFFECTIVE OCTOBER 17, 2022

Featured Models

2-STAGE T-LEG :: \$1,198

2-Stage T-leg base, 24" x 60" laminate top, grade 1 laminate, no grommets, glides

3-STAGE T-LEG :: \$1,409

3-Stage T-leg base, 30" x 60" laminate top, grade 1 laminate, no grommets, glides

3-Stage C-leg base, 30" x 72" laminate top, grade 1 laminate, no grommets, glides

3-STAGE C-LEG :: \$1,489

2-LEG HEIGHT-ADJUSTABLE TABLE

TOPS AND BASES ARE SPECIFIED AND SOLD SEPARATELY.

Features

- Gyro anti-collision technology from a patented sensor stops (and retracts) the table when it makes contact with any object
- Push-button controls with four user-customized positions
- Available with T-leg or C-leg options
- Eleven different durable laminate options to fit your style
- Three durable powder-coated metal base finishes in silver, black or white
- Optional grommets for easy and clean setup of electronic devices
- Chicago Code Compliant (3-conductor type cord with grounded 3-prong molded case plug)
- Meets G1 ANSI BIFMA Certification

SPECIFICATIONS

	3161 TBT6/ TBT6C 2-Stage Switchback	3161 TBT8/ TBT7C 3-Stage Switchback
Height Range	27.9"-47.625"	22.6"-48.7"
Foot Length With 24" Wide Tabletop	21.65" (T-Leg) 22.83" (C-Leg)	21.65" (T-Leg) 22.83" (C-Leg)
Foot Length With 30" Wide Tabletop	29.53"	29.53"
Tabletop Thickness	1.125"	1.125"
Adjustment Speed	1.22" Per Second	1.5" Per Second
Standby Power Consumption	<0.1W	<0.1W
Noise	Approximately 39 DB	Approximately 39 DB
Power Cord Length	98.5"	98.5"
Weight Capacity Warranty	220 lb	265 lb

Height range includes 1.125" tabletop.

See the Stand-Alone Tabletop appendix on [page 588](#) for tabletop weights.

TABLETOP FOR 2-LEG BASE

TOPS AND BASES ARE SPECIFIED AND SOLD SEPARATELY.

1. Product

Product Type	Code	Price
Tabletop	3161	Priced by Size

Product Style	Code	Price
For 2-Stage T-Leg Base	TBT6	Priced by Size
For 3-Stage T-Leg Base	TBT7	Priced by Size
For 2-Stage C-Leg Base	TBT6C	Priced by Size
For 3-Stage, C-Leg Base	TBT7C	Priced by Size

2. Finish

Laminate Color	Code	Price
Grade 1		
Ankara Cherry	TL18	Priced by Size
Black	TL19	Priced by Size
Brazilian Walnut	TL20	Priced by Size
Cabinet Maple	TL21	Priced by Size
Driftwood	TL23	Priced by Size
Folkstone Grey	TL24	Priced by Size
Libretti	TL25	Priced by Size
Queenston Oak	TL26	Priced by Size
Sandalwood	TL27	Priced by Size
Walnut Amati	TL28	Priced by Size
White	TL29	Priced by Size
Grade 2		
Classic Linen	TL17	Priced by Size
Colombian Walnut	TL55	Priced by Size
Crisp Linen	TL64	Priced by Size
Designer White	TL66	Priced by Size
Field Elm	TL13	Priced by Size
Frosty White	TL16	Priced by Size
Grey	TL62	Priced by Size
Grey Elm	TL51	Priced by Size
Kingswood Walnut	TL53	Priced by Size
Manitoba	TL56	Priced by Size
Neo Walnut	TL50	Priced by Size
Platinum	TL61	Priced by Size
Portico Teak	TL60	Priced by Size
Skyline Walnut	TL15	Priced by Size
Steel Mesh	TL59	Priced by Size
Tuscan Walnut	TL57	Priced by Size
Uptown Walnut	TL14	Priced by Size
Laminate Grade	Code	Price
Laminate Grade 1	GR1	Priced by Size
Laminate Grade 2	GR2	Priced by Size

3. Shape

Tabletop Shape	Code	Price
Rectangular Tabletop	TZ	Priced by Size

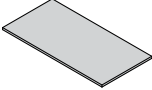

4. Size

Tabletop Size (D x W)	Code	Price	
Standard Sizes		Grade 1	Grade 2
24" x 42"	2442	\$229	\$344
24" x 48"	2448	\$261	\$392
24" x 54"	2454	\$292	\$438
24" x 60"	2460	\$324	\$486
24" x 66"	2466	\$358	\$537
24" x 72"	2472	\$389	\$584
24" x 78"	2478	\$421	\$632
24" x 84"	2484	\$453	\$680
30" x 42"	3042	\$285	\$428
30" x 48"	3048	\$324	\$486
30" x 54"	3054	\$366	\$549
30" x 60"	3060	\$404	\$606
30" x 66"	3066	\$445	\$668
30" x 72"	3072	\$484	\$726
30" x 78"	3078	\$526	\$789
30" x 84"	3084	\$565	\$848
For Use with eBEAM (-2")		Grade 1	Grade 2
24" x 46"	2446	\$261	\$392
24" x 58"	2458	\$324	\$486
24" x 70"	2470	\$389	\$584
30" x 46"	3046	\$324	\$486
30" x 58"	3058	\$404	\$606
30" x 70"	3070	\$484	\$726

EFFECTIVE OCTOBER 17, 2022 | GSA SIN #: 33721

5. Grommets

Grommet Location	Code	Price
None	GP00	+ \$0
Left	GP01	+ \$30
Center	GP02	+ \$30
Right	GP03	+ \$30
Left and Center	GP04	+ \$60
Left and Right	GP05	+ \$60
Right and Center	GP06	+ \$60
Left, Right and Center	GP07	+ \$90

Grommet Color	Code	Price
Black	GC01	+ \$0
White	GC02	+ \$0

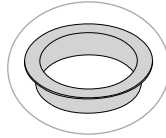

3-Stage C-Leg
 Chair sold separately; see [page 184](#) for Wit.

SWITCHBACK

EFFECTIVE OCTOBER 17, 2022 | GSA SIN #: 33721

1. Product

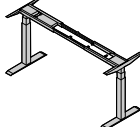
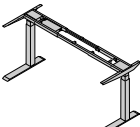
Product Type	Code	Price	
Switchback 2-Leg Base	3162	Priced by Style	
Product Style	Code	Price	
2-Stage T-Leg Base	TBT6	\$874	
3-Stage T-Leg Base	TBT7	\$1,005	
2-Stage C-Leg Base	TBT6C	\$874	
3-Stage C-Leg Base	TBT7C	\$1,005	

2. Base Finish

Paint Color	Code	Price
Silver	BF01	+ \$0
White	BF02	+ \$0
Black	BF03	+ \$0

2-LEG HEIGHT-ADJUSTABLE BASE

TOPS AND BASES ARE SPECIFIED AND SOLD SEPARATELY.

3. Matching Tabletop

Tabletop Shape	Code	Price	
Rectangular Tabletop	TZ	Priced by Size	
Tabletop Size	Code	Price	
Standard Sizes (D x W)			
24" x 42"	2442	+ \$0	
24" x 48"	2448	+ \$0	
24" x 54"	2454	+ \$0	
24" x 60"	2460	+ \$0	
24" x 66"	2466	+ \$0	
24" x 72"	2472	+ \$0	
24" x 78"	2478	+ \$0	
24" x 84"	2484	+ \$0	
30" x 42"	3042	+ \$0	
30" x 48"	3048	+ \$0	
30" x 54"	3054	+ \$0	
30" x 60"	3060	+ \$0	
30" x 66"	3066	+ \$0	
30" x 72"	3072	+ \$0	
30" x 78"	3078	+ \$0	
30" x 84"	3084	+ \$0	
For Use with eBEAM (-2") (D x W)			
24" x 46"	2446	+ \$0	
24" x 58"	2458	+ \$0	
24" x 70"	2470	+ \$0	
30" x 46"	3046	+ \$0	
30" x 58"	3058	+ \$0	
30" x 70"	3070	+ \$0	

Bases require the specification of a tabletop size. Bases take their size from their corresponding tabletop size.

4. Feet

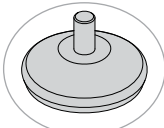
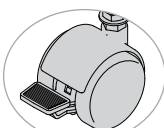
Foot Style	Code	Price	
Glides	LS18	+ \$0	
Casters	LS19	+ \$109	

Switchback

3-LEG HEIGHT-ADJUSTABLE TABLE TYPICALS

Find your fit.

Achieving the perfect position maximizes ergonomics and minimizes fatigue or injury. With the press of a button, you can make the Switchback height-adjustable table elevate the way you work while ensuring it matches your unique needs. Configure your height-adjustable table with a variety of leg options and an extensive portfolio of top shapes and workstation add-ons. All that and quick installation make Switchback a leading solution in simplicity and endless versatility.



T-Shape Collaborative



U-Shape



Pod



Extended Offset U-Shape



Extended Offset Corner With Return

EFFECTIVE OCTOBER 17, 2022 | GSA SIN #: 33721

1. Pod Typical

Category	Code	Quantity	Description	List Price	Ext. Price	
Tabletop	3161 TBT8C TA2448 TL27 GR1 GP00	3	120-Degree Tabletop: 24" x 48", Laminate, Grade 1 Laminate, No Grommets	\$908	\$2,724	
Table Base	3162 TBT8C TA2448 BF01	3	3-Leg Base (Pairs With 24" x 48" 120-Degree Tabletop)	\$1,705	\$5,115	

TOTAL: \$7,839

2. U-Shape Typical

Category	Code	Quantity	Description	List Price	Ext. Price	
Tabletop	3161 TBT8C TBCR2448 TL27 GR1 GP00	1	Right 90-Degree Tabletop: 24" x 48", Grade 1 Laminate, No Grommets	\$517	\$517	
Tabletop	3161 TBT8C TBCL2448 GR1 TL27 GP00	1	Left 90-Degree Tabletop: 24" x 48", Grade 1 Laminate, No Grommets	\$517	\$517	
Table Base	3162 TBT8C TBCL2448 BF01	1	3-Leg Base (Pairs With 24" x 48" 90-Degree Left Tabletop)	\$1,705	\$1,705	
Table Base	3162 TBT8C TBCR2448 BF01	1	3-Leg Base (Pairs With 24" x 48" 90-Degree Right Tabletop)	\$1,705	\$1,705	

TOTAL: \$4,444

3. Extended Offset U-Shape Typical

Category	Code	Quantity	Description	List Price	Ext. Price	
Tabletop	3161 TBT8C OR24367230 TL27 GR1 GP00	1	Right Extended Offset Corner Tabletop: 24" x 36" x 72" x 30", Grade 1 Laminate, No Grommets	\$685	\$685	
Tabletop	3161 TBT8C OL30723624 GR1 TL27 GP00	1	Left Extended Offset Corner Tabletop: 30" x 72" x 36" x 24", Grade 1 Laminate, No Grommets	\$685	\$685	
Return Top	3164 TBT8C TN2436 TL27 GR1 GPR00	2	Return Top: 24" x 36", Grade 1 Laminate, No Grommets	\$196	\$392	
Table Base	3162 TBT8C OR24367230 TN2436 BF01	1	3-Leg Base, Cross Beam and Extension Cable (Pairs With 24" x 36" x 72" x 30" Right Extended Offset Corner Tabletop and 24" x 36" Return Top)	\$1,929	\$1,929	
Table Base	3162 TBT8C OL30723624 TN2436 BF01	1	3-Leg Base, Cross Beam and Extension Cable (Pairs With 30" x 72" x 36" x 24" Left Extended Offset Corner Tabletop and 24" x 36" Return Top)	\$1,929	\$1,929	

TOTAL: \$5,620

EFFECTIVE OCTOBER 17, 2022 | GSA SIN #: 33721

4. Extended Offset Corner With Return Typical

Category	Code	Quantity	Description	List Price	Ext. Price
Tabletop	3161 TBT8C OL30723624 TL27 GR1 GP00	1	Left Extended Offset Corner Tabletop: 24" x 36" x 72" x 30", Laminate, No Grommets	\$685	\$685
Return Top	3164 TBT8C TN2436 TL27 GR1 GPR00	1	Return Top: 24" x 36", Laminate, No Grommets	\$196	\$196
Table Base	3162 TBT8C OL30723624 TN2436 BF01	1	3-Leg Base, Cross Beam and Extension Cable (Pairs With 24" x 36" x 72" x 30" Left Extended Corner Tabletop and 24" x 36" Return Top)	\$1,929	\$1,929

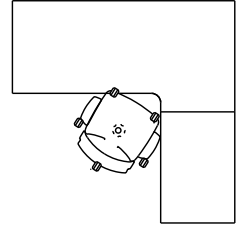

TOTAL: \$2,810

5. T-Shape Collaborative Typical

Category	Code	Quantity	Description	List Price	Ext. Price
Tabletop	3161 TBT8C TZ3072 TL27 GR1 GP00	2	Rectangular Tabletop: 30" x 72", Laminate, No Grommets	\$484	\$968
Return Top	3164 TBT8C TN2442 TL27 GR1 GPR00	2	Return Top: 24" x 42", Laminate, No Grommets	\$229	\$458
Table Base	3162 TBT8C TZ3072 TN2442 BF01	2	3-Leg Base, Cross Beam and Extension Cable (Pairs With 30" x 72" Tabletop and 24" x 42" Return)	\$1,929	\$3,858

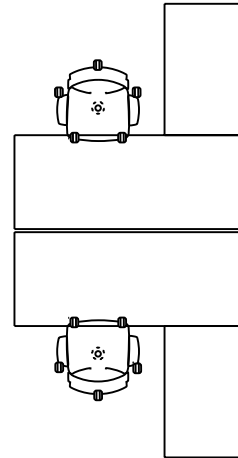

TOTAL: \$5,284

Switchback

3-LEG HEIGHT-ADJUSTABLE TABLE

Find your fit.

Achieving the perfect position maximizes ergonomics and minimizes fatigue or injury. With the press of a button, you can make the Switchback height-adjustable table elevate the way you work while ensuring it matches your unique needs. Configure your Switchback with a variety of leg options and an extensive portfolio of tabletop shapes and workstation add-ons. All that and quick installation make Switchback a leading solution in simplicity and endless versatility.



3-Leg 120-Degree
Chair sold separately;
see [page 174](#) for Vectra

EFFECTIVE OCTOBER 17, 2022

Featured Models

3-LEG 90° :: \$2,350

3-leg base with 24" × 60"
90° corner tabletop, laminate grade 1,
no grommets

3-LEG 120° :: \$2,613

3-leg base with 24" × 48"
120° tabletop, laminate grade 1,
no grommets

3-LEG EXTENDED :: \$2,854

3-leg base with 24" × 48" × 72"
right extended corner tabletop,
24" × 24" return top,
laminate grade 1, no grommets

Features

- Gyro anti-collision technology from a patented sensor stops (and retracts) the table when it makes contact with any object
- Push-button controls with four user-customized positions
- C-leg base
- Eleven different durable laminate options to fit your style
- Three durable powder-coated metal finishes in silver, black or white
- Optional grommets for easy and clean setup of electronic devices
- Chicago Code Compliant (3-conductor type cord with grounded 3-prong molded case plug)
- Meets G1 ANSI BIFMA Certification

3-LEG HEIGHT-ADJUSTABLE TABLE

TOPS AND BASES ARE SPECIFIED AND SOLD SEPARATELY.

SPECIFICATIONS

	C-Leg Switchback
Height Range	22.6"-48.7"
Foot Length With 24" Wide Tabletop	22.83"
Foot Length With 30" Wide Tabletop	29.53"
Tabletop Thickness	1.125"
Adjustment Speed	1.5" Per Second
Standby Power Consumption	<0.1W
Noise	Approximately 39 DB
Power Cord Length	98.5"
Weight Capacity Warranty	265 lb

Height range includes 1.125" tabletop.

See the Stand-Alone Tabletop appendix on [page 588](#) for tabletop weights.

1. Product

Product Type	Code	Price
Tabletop	3161	Priced by Size
Product Style	Code	Price
For Switchback 3-Leg 3-Stage C-Leg Base	TBT8C	Priced by Size

2. Finish

Laminate Color	Code	Price
Grade 1 Laminate		
Ankara Cherry	TL18	Priced by Size
Black	TL19	Priced by Size
Brazilian Walnut	TL20	Priced by Size
Cabinet Maple	TL21	Priced by Size
Driftwood	TL23	Priced by Size
Folkstone Grey	TL24	Priced by Size
Libretti	TL25	Priced by Size
Queenston Oak	TL26	Priced by Size
Sandalwood	TL27	Priced by Size
Walnut Amati	TL28	Priced by Size
White	TL29	Priced by Size
Grade 2 Laminate		
Classic Linen	TL17	Priced by Size
Colombian Walnut	TL55	Priced by Size
Crisp Linen	TL64	Priced by Size
Designer White	TL66	Priced by Size
Field Elm	TL13	Priced by Size
Frosty White	TL16	Priced by Size
Grey	TL62	Priced by Size
Grey Elm	TL51	Priced by Size
Kingswood Walnut	TL53	Priced by Size
Manitoba	TL56	Priced by Size
Neo Walnut	TL50	Priced by Size
Platinum	TL61	Priced by Size
Portico Teak	TL60	Priced by Size
Skyline Walnut	TL15	Priced by Size
Steel Mesh	TL59	Priced by Size
Tuscan Walnut	TL57	Priced by Size
Uptown Walnut	TL14	Priced by Size
Laminate Grade	Code	Price
Laminate Grade 1	GR1	Priced by Size
Laminate Grade 2	GR2	Priced by Size

1-PIECE TABLETOP FOR 3-LEG BASE

TOPS AND BASES ARE SPECIFIED AND SOLD SEPARATELY.

3. Shape

Tabletop Shape	Code	Price
120-Degree Tabletop	TA	Priced by Size
Right 90-Degree Tabletop	TBCR	Priced by Size
Left 90-Degree Tabletop	TBCL	Priced by Size

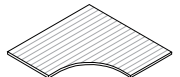
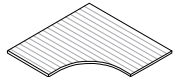
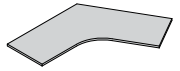

4. Size

Tabletop Size	Code	Price
120-Degree (D x W)		Grade 1
24" x 42"	TA2442	\$705
24" x 48"	TA2448	\$908
30" x 42"	TA3042	\$736
30" x 48"	TA3048	\$917
Right 90-Degree Corner (D x W)		Grade 1
24" x 48"	TBCR2448	\$517
24" x 54"	TBCR2454	\$582
24" x 60"	TBCR2460	\$645
30" x 48"	TBCR3048	\$645
30" x 54"	TBCR3054	\$729
30" x 60"	TBCR3060	\$805
Left 90-Degree Corner (D x W)		Grade 1
24" x 48"	TBCL2448	\$517
24" x 54"	TBCL2454	\$582
24" x 60"	TBCL2460	\$645
30" x 48"	TBCL3048	\$645
30" x 54"	TBCL3054	\$729
30" x 60"	TBCL3060	\$805

EFFECTIVE OCTOBER 17, 2022 | GSA SIN #: 33721

5. Grommets

Grommet Location	Code	Price
None	GP00	+ \$0
Left	GP01	+ \$30
Center	GP02	+ \$30
Right	GP03	+ \$30
Left and Center	GP04	+ \$60
Left and Right	GP05	+ \$60
Right and Center	GP06	+ \$60
Left, Right and Center	GP07	+ \$90

Grommet Color	Code	Price
Black	GC01	+ \$0
White	GC02	+ \$0

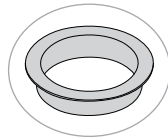

3-Leg 120°
Chair sold separately;
see page 180 for Vectra

SWITCHBACK

EFFECTIVE OCTOBER 17, 2022 | GSA SIN #: 33721

1. Product

Product Type	Code	Price
Switchback 3-Leg Base	3162	Priced by Style

Product Style	Code	Price
---------------	------	-------

3-Stage C-Leg Base

TBT8C

\$1,705

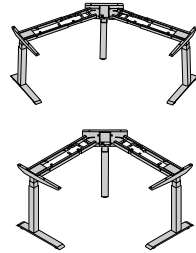

2. Base Finish

Paint Color	Code	Price
Silver	BF01	+ \$0
White	BF02	+ \$0
Black	BF03	+ \$0

3-LEG BASE FOR 1-PIECE TOP

TOPS AND BASES ARE SPECIFIED AND SOLD SEPARATELY.

3. Matching Tabletop

Tabletop Shape	Code	Price
120-Degree Tabletop	TA	Priced by Size
Right 90-Degree Tabletop	TBCR	Priced by Size
Left 90-Degree Tabletop	TBCL	Priced by Size

Tabletop Size	Code	Price
120-Degree Top		
Depth x Width		
24" x 42"	2442	+ \$0
24" x 48"	2448	+ \$0
30" x 42"	3042	+ \$0
30" x 48"	3048	+ \$0

Depth x Width	Right 90-Degree Corner Tabletop	
24" x 48"	2448	+ \$0
24" x 54"	2454	+ \$0
24" x 60"	2460	+ \$0
30" x 48"	3048	+ \$0
30" x 54"	3054	+ \$0
30" x 60"	3060	+ \$0

Depth x Width	Left 90-Degree Corner Tabletop	
24" x 48"	2448	+ \$0
24" x 54"	2454	+ \$0
24" x 60"	2460	+ \$0
30" x 48"	3048	+ \$0
30" x 54"	3054	+ \$0
30" x 60"	3060	+ \$0

Bases require the specification of a tabletop size. Bases take their size from their corresponding tabletop size.

SWITCHBACK

EFFECTIVE OCTOBER 17, 2022 | GSA SIN #: 33721

1. Product

Product Type	Code	Price
Switchback Tabletop	3161	Priced by Size

Product Style	Code	Price
For 3-Leg 3-Stage C-Leg Base	TBT8C	Priced by Size

2. Finish

Laminate	Code	Price
Grade 1 Laminate		
Ankara Cherry	TL18	Priced by Size
Black	TL19	Priced by Size
Brazilian Walnut	TL20	Priced by Size
Cabinet Maple	TL21	Priced by Size
Driftwood	TL23	Priced by Size
Folkstone Grey	TL24	Priced by Size
Libretti	TL25	Priced by Size
Queenston Oak	TL26	Priced by Size
Sandalwood	TL27	Priced by Size
Walnut Amati	TL28	Priced by Size
White	TL29	Priced by Size
Grade 2 Laminate		
Classic Linen	TL17	Priced by Size
Colombian Walnut	TL55	Priced by Size
Crisp Linen	TL64	Priced by Size
Designer White	TL66	Priced by Size
Field Elm	TL13	Priced by Size
Frosty White	TL16	Priced by Size
Grey	TL62	Priced by Size
Grey Elm	TL51	Priced by Size
Kingswood Walnut	TL53	Priced by Size
Manitoba	TL56	Priced by Size
Neo Walnut	TL50	Priced by Size
Platinum	TL61	Priced by Size
Portico Teak	TL60	Priced by Size
Skyline Walnut	TL15	Priced by Size
Steel Mesh	TL59	Priced by Size
Tuscan Walnut	TL57	Priced by Size
Uptown Walnut	TL14	Priced by Size

Laminate Grade	Code	Price
Laminate Grade 1	GR1	Priced by Size
Laminate Grade 2	GR2	Priced by Size

TABLETOP FOR 3-LEG BASE AND RETURN

TOPS AND BASES ARE SPECIFIED AND SOLD SEPARATELY.

3. Shape

Tabletop Shape	Code	Price
Rectangular	TZ	Priced by Size
Right Extended Corner	TXR	Priced by Size
Left Extended Corner	TXL	Priced by Size
Right Extended Offset	OR	Priced by Size
Left Extended Offset	OL	Priced by Size

4. Size

Tabletop Size	Code	Laminate Price	
		Grade 1	Grade 2
Rectangular (D x W)			
24" x 48"	2448	\$261	\$392
24" x 54"	2454	\$292	\$438
24" x 60"	2460	\$324	\$486
24" x 66"	2466	\$358	\$537
24" x 72"	2472	\$389	\$584
30" x 48"	3048	\$324	\$486
30" x 54"	3054	\$366	\$549
30" x 60"	3060	\$404	\$606
30" x 66"	3066	\$445	\$668
30" x 72"	3072	\$484	\$726

4. Size (Cont.)

Tabletop Size (Cont.)	Code	Laminate Price	
Right Extended Corner (A x B x C)		Grade 1	Grade 2
24" x 36" x 60"	243660	\$485	\$728
24" x 36" x 66"	243666	\$547	\$821
24" x 36" x 72"	243672	\$618	\$927
24" x 42" x 60"	244260	\$557	\$836
24" x 42" x 66"	244266	\$629	\$944
24" x 42" x 72"	244272	\$710	\$1,065
24" x 48" x 60"	244860	\$613	\$920
24" x 48" x 66"	244866	\$692	\$1,038
24" x 48" x 72"	244872	\$781	\$1,172
30" x 36" x 60"	303660	\$557	\$836
30" x 36" x 66"	303666	\$629	\$944
30" x 36" x 72"	303672	\$760	\$1,140
30" x 42" x 60"	304260	\$640	\$960
30" x 42" x 66"	304266	\$723	\$1,085
30" x 42" x 72"	304272	\$817	\$1,226
30" x 48" x 60"	304860	\$672	\$1,008
30" x 48" x 66"	304866	\$760	\$1,140
30" x 48" x 72"	304872	\$860	\$1,290
Left Extended Corner (A x B x C)		Grade 1	Grade 2
24" x 60" x 36"	246036	\$485	\$728
24" x 66" x 36"	246636	\$547	\$821
24" x 72" x 36"	247236	\$618	\$927
24" x 60" x 42"	246042	\$557	\$836
24" x 66" x 42"	246642	\$629	\$944
24" x 72" x 42"	247242	\$710	\$1,065
24" x 60" x 48"	246048	\$613	\$920
24" x 66" x 48"	246648	\$692	\$1,038
24" x 72" x 48"	247248	\$781	\$1,172
30" x 60" x 36"	306036	\$557	\$836
30" x 66" x 36"	306636	\$629	\$944
30" x 72" x 36"	307236	\$760	\$1,140
30" x 60" x 42"	306042	\$640	\$960
30" x 66" x 42"	306642	\$723	\$1,085
30" x 72" x 42"	307242	\$817	\$1,226
30" x 60" x 48"	306048	\$672	\$1,008
30" x 66" x 48"	306648	\$760	\$1,140
30" x 72" x 48"	307248	\$860	\$1,290

On extended corner tops, the main desk and return have equal depth. Multipiece tops must be paired with returns.

TABLETOP FOR 3-LEG BASE AND RETURN TOPS AND BASES ARE SPECIFIED AND SOLD SEPARATELY.

4. Size (Cont.)

Tabletop Size (Cont.)	Code	Laminate Price	
Right Extended Offset (A x B x C x D)		Grade 1	Grade 2
24" x 36" x 60" x 30"	24366030	\$531	\$797
24" x 36" x 66" x 30"	24366630	\$604	\$906
24" x 36" x 72" x 30"	24367230	\$685	\$1,028
24" x 42" x 60" x 30"	24426030	\$616	\$924
24" x 42" x 66" x 30"	24426630	\$697	\$1,046
24" x 42" x 72" x 30"	24427230	\$793	\$1,190
24" x 48" x 60" x 30"	24486030	\$648	\$972
24" x 48" x 66" x 30"	24486630	\$735	\$1,103
24" x 48" x 72" x 30"	24487230	\$835	\$1,253
Left Extended Offset (A x B x C x D)		Grade 1	Grade 2
30" x 60" x 36" x 24"	30603624	\$531	\$797
30" x 66" x 36" x 24"	30663624	\$604	\$906
30" x 72" x 36" x 24"	30723624	\$685	\$1,028
30" x 60" x 42" x 24"	30604224	\$616	\$924
30" x 66" x 42" x 24"	30664224	\$697	\$1,046
30" x 72" x 42" x 24"	30724224	\$793	\$1,190
30" x 60" x 48" x 24"	30604824	\$648	\$972
30" x 66" x 48" x 24"	30664824	\$735	\$1,103
30" x 72" x 48" x 24"	30724824	\$835	\$1,253

On extended offset corner tops, the main desk has a depth of 30", which tapers down to a depth of 24" on the return. Multipiece tops must be paired with returns.

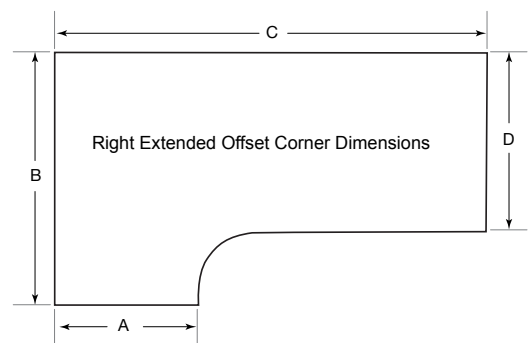
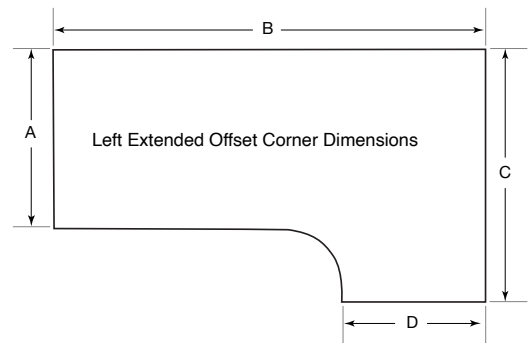

EFFECTIVE OCTOBER 17, 2022 | GSA SIN #: 33721

5. Grommets

Grommet Location	Code	Price
None	GP00	+ \$0
Left	GP01	+ \$30
Center	GP02	+ \$30
Right	GP03	+ \$30
Left and Center	GP04	+ \$60
Left and Right	GP05	+ \$60
Right and Center	GP06	+ \$60
Left, Right and Center	GP07	+ \$90

Grommet Color	Code	Price
Black	GC01	+ \$0
White	GC02	+ \$0

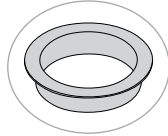

Left grommets (GP01/GP04/GP05/GP07) are not available on right extended corners or right extended offset corners.

Right grommets (GP03/GP05/GP06/GP07) are not available on left extended corners or left extended offset corners.



3-Leg Extended Corner
 Chair sold separately;
 see [page 127](#) for Novo.

1. Product

Product Type	Code	Price
Return Top	3164	Priced by Size
Product Style	Code	Price
For Switchback 3-Leg 3-Stage C-Leg Base	TBT8C	Priced by Size

2. Finish

Laminate	Code	Price
Grade 1 Laminate		
Ankara Cherry	TL18	Priced by Size
Black	TL19	Priced by Size
Brazilian Walnut	TL20	Priced by Size
Cabinet Maple	TL21	Priced by Size
Driftwood	TL23	Priced by Size
Folkstone Grey	TL24	Priced by Size
Libretti	TL25	Priced by Size
Queenston Oak	TL26	Priced by Size
Sandalwood	TL27	Priced by Size
Walnut Amati	TL28	Priced by Size
White	TL29	Priced by Size
Grade 2 Laminate		
Classic Linen	TL17	Priced by Size
Colombian Walnut	TL55	Priced by Size
Crisp Linen	TL64	Priced by Size
Designer White	TL66	Priced by Size
Field Elm	TL13	Priced by Size
Frosty White	TL16	Priced by Size
Grey	TL62	Priced by Size
Grey Elm	TL51	Priced by Size
Kingswood Walnut	TL53	Priced by Size
Manitoba	TL56	Priced by Size
Neo Walnut	TL50	Priced by Size
Platinum	TL61	Priced by Size
Portico Teak	TL60	Priced by Size
Skyline Walnut	TL15	Priced by Size
Steel Mesh	TL59	Priced by Size
Tuscan Walnut	TL57	Priced by Size
Uptown Walnut	TL14	Priced by Size
Laminate Grade	Code	Price
Laminate Grade 1	GR1	Priced by Size
Laminate Grade 2	GR2	Priced by Size

RETURN TOP FOR 3-LEG BASE

TOPS AND BASES ARE SPECIFIED AND SOLD SEPARATELY.

3. Shape

Product Shape	Code	Price
Rectangular Return	TN	Priced by Size

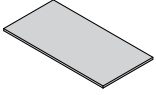

4. Size

Return Top Size	Code	Laminate Price	
Rectangular (D x W)	Code	Grade 1	Grade 2
24" x 24"	2424	\$144	\$216
24" x 30"	2430	\$165	\$248
24" x 36"	2436	\$196	\$294
24" x 42"	2442	\$229	\$344
24" x 48"	2448	\$261	\$392
30" x 24"	3024	\$172	\$258
30" x 30"	3030	\$205	\$308
30" x 36"	3036	\$244	\$366
30" x 42"	3042	\$285	\$428

5. Grommets

Grommet Location	Code	Price
None	GPR00	+ \$0
Left	GPR01	+ \$30
Center	GPR02	+ \$30
Right	GPR03	+ \$30
Grommet Color	Code	Price
Black	GC01	+ \$0
White	GC02	+ \$0

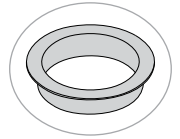

SWITCHBACK

EFFECTIVE OCTOBER 17, 2022 | GSA SIN #: 33721

1. Base

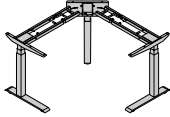
Product Type	Code	Base	
3-Leg 3-Stage C-Leg Base	3162 TBT8C	\$1,705	

2. Finish

Paint Color	Code	Price	
Silver	BF01	+ \$0	
White	BF02	+ \$0	
Black	BF03	+ \$0	

3. Matching Tabletop

Tabletop Shape	Code	Price	
Rectangular	TZ	+ \$0	
Right Extended Corner	TXR	+ \$0	
Left Extended Corner	TXL	+ \$0	
Right Extended Offset	OR	+ \$0	
Left Extended Offset	OL	+ \$0	

Tabletop Size	Code	Price	
Rectangular (D x W)			
24" x 48"	2448	+ \$0	
24" x 54"	2454	+ \$0	
24" x 60"	2460	+ \$0	
24" x 66"	2466	+ \$0	
24" x 72"	2472	+ \$0	
30" x 48"	3048	+ \$0	
30" x 54"	3054	+ \$0	
30" x 60"	3060	+ \$0	
30" x 66"	3066	+ \$0	
30" x 72"	3072	+ \$0	

3-LEG BASE FOR TABLETOP AND RETURN

TOPS AND BASES ARE SPECIFIED AND SOLD SEPARATELY.

3. Matching Tabletop Size (Cont.)

Tabletop Size	Code	Price	
Right Extended Corner (A x B x C)			
24" x 36" x 60"	243660	+ \$0	
24" x 36" x 66"	243666	+ \$0	
24" x 36" x 72"	243672	+ \$0	
24" x 42" x 60"	244260	+ \$0	
24" x 42" x 66"	244266	+ \$0	
24" x 42" x 72"	244272	+ \$0	
24" x 48" x 60"	244860	+ \$0	
24" x 48" x 66"	244866	+ \$0	
24" x 48" x 72"	244872	+ \$0	
30" x 36" x 60"	303660	+ \$0	
30" x 36" x 66"	303666	+ \$0	
30" x 36" x 72"	303672	+ \$0	
30" x 42" x 60"	304260	+ \$0	
30" x 42" x 66"	304266	+ \$0	
30" x 42" x 72"	304272	+ \$0	
30" x 48" x 60"	304860	+ \$0	
30" x 48" x 66"	304866	+ \$0	
30" x 48" x 72"	304872	+ \$0	
Left Extended Corner (A x B x C)			
24" x 60" x 36"	246036	+ \$0	
24" x 66" x 36"	246636	+ \$0	
24" x 72" x 36"	247236	+ \$0	
24" x 60" x 42"	246042	+ \$0	
24" x 66" x 42"	246642	+ \$0	
24" x 72" x 42"	247242	+ \$0	
24" x 60" x 48"	246048	+ \$0	
24" x 66" x 48"	246648	+ \$0	
24" x 72" x 48"	247248	+ \$0	
30" x 60" x 48"	306048	+ \$0	
30" x 66" x 36"	306636	+ \$0	
30" x 72" x 36"	307236	+ \$0	
30" x 60" x 42"	306042	+ \$0	
30" x 66" x 42"	306642	+ \$0	
30" x 72" x 42"	307242	+ \$0	
30" x 60" x 48"	306048	+ \$0	
30" x 66" x 48"	306648	+ \$0	
30" x 72" x 48"	307248	+ \$0	

3-LEG BASE FOR TABLETOP AND RETURN

TOPS AND BASES ARE SPECIFIED AND SOLD SEPARATELY.

3. Matching Tabletop Size (Cont.)

Tabletop Size	Code	Price
Right Extended Offset (A x B x C x D)		
24" x 36" x 60" x 30"	24366030	+ \$0
24" x 36" x 66" x 30"	24366630	+ \$0
24" x 36" x 72" x 30"	24367230	+ \$0
24" x 42" x 60" x 30"	24426030	+ \$0
24" x 42" x 66" x 30"	24426630	+ \$0
24" x 42" x 72" x 30"	24427230	+ \$0
24" x 48" x 60" x 30"	24486030	+ \$0
24" x 48" x 66" x 30"	24486630	+ \$0
24" x 48" x 72" x 30"	24487230	+ \$0
Left Extended Offset (A x B x C x D)		
30" x 60" x 36" x 24"	30603624	+ \$0
30" x 66" x 36" x 24"	30663624	+ \$0
30" x 72" x 36" x 24"	30723624	+ \$0
30" x 60" x 42" x 24"	30604224	+ \$0
30" x 66" x 42" x 24"	30664224	+ \$0
30" x 72" x 42" x 24"	30724224	+ \$0
30" x 60" x 48" x 24"	30604824	+ \$0
30" x 66" x 48" x 24"	30664824	+ \$0
30" x 72" x 48" x 24"	30724824	+ \$0

Bases require the specification of a tabletop size. Bases take their size from their corresponding tabletop size.

4. Matching Return

Return Shape	Code	Price
Rectangular Return	TN	Priced by Size
Return Top Size		
No Return	TN0	+ \$0
24" x 24"	TN2424	+ \$74
24" x 30"	TN2430	+ \$74
24" x 36"	TN2436	+ \$74
24" x 42"	TN2442	+ \$74
24" x 48"	TN2448	+ \$74
30" x 24"	TN3024	+ \$74
30" x 30"	TN3030	+ \$74
30" x 36"	TN3036	+ \$74
30" x 42"	TN3042	+ \$74

5. Base Extension

Parts	Code	Price
Cross Beam and Extension Cable	No Code	+ \$150

A base extension charge will be added automatically if the A or D measurement is equal to 72".

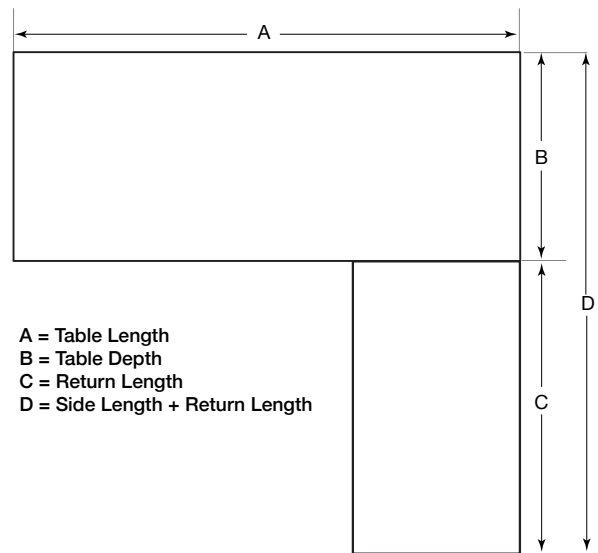
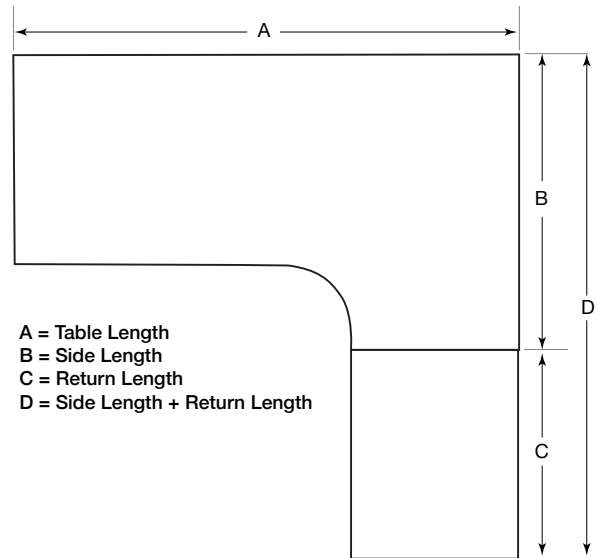

Tensor

CAFÉ, CLASSROOM, AND OFFICE TYPICALS

As your business grows and changes, your workspace should be able to keep up. That's why we created Tensor—one table that can adapt to your changing needs. It's the only table that can expand to support multiple tops on a single base. This allows you to install and reconfigure to fit any space quickly and easily.



L-Shaped With Main and Return



Conference



U-Shaped With Bridge



Multipurpose U-Shape



Classroom-Style Training



Café

EFFECTIVE OCTOBER 17, 2022

1. Café Typical

Category	Code	Quantity	Description	List Price	Ext Price	
Tabletop	3231 TBT9 TZ1872 TL27 GP00	2	Rectangular Tabletop: 18" x 72", Laminate, No Grommets	\$300	\$600	
Tabletop	3231 TBT9 TS4242 TL27	2	Square Tabletop: 42" x 42", Laminate	\$385	\$770	
Tabletop	3231 TBT9 TR4242 TL27	2	Round Tabletop: 42" x 42", Laminate	\$385	\$770	
Table Base	3232 TBT9 TZ1872 BF01	2	Base (Pairs With Rectangular 18" x 72" Tabletop)	\$606	\$1,212	
Table Base	3232 TBT9 TS4242 BF01	2	Base (Pairs With 42" x 42" Square Tabletop)	\$533	\$1,066	
Table Base	3232 TBT9 TR4242 BF01	2	Base (Pairs With 42" x 42" Round Tabletop)	\$533	\$1,066	
					TOTAL:	\$5,484

2. Classroom-Style Training Typical

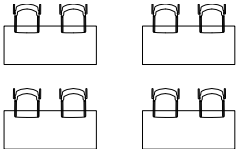
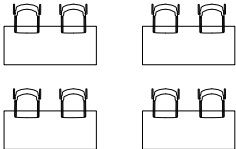
Category	Code	Quantity	Description	List Price	Ext Price	
Tabletop	3231 TBT9 TZ3072 TL24 GP00	8	Rectangular Tabletop: 30" x 72", Laminate, No Grommets	\$484	\$3,872	
Table Base	3232 TBT9 TZ3072 BF01	8	Base (Pairs With 30" x 72" Rectangular Tabletop)	\$606	\$4,848	
					TOTAL:	\$8,720

3. Multipurpose U-Shape Typical

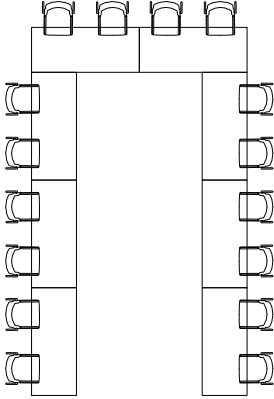
Category	Code	Quantity	Description	List Price	Ext Price	
Tabletop	3231 TBT9 TZ3072 TL22 GP00	8	Rectangular Tabletop: 30" x 72", Laminate, No Grommets	\$484	\$3,872	
Table Base	3232 TBT9 TZ3072 BF01	8	Base (Pairs With 30" x 72" Rectangular Tabletop)	\$606	\$4,848	
Accessories	3159 ATC03 XGV	7	Two Pairs of Ganging Brackets	\$50	\$350	
					TOTAL:	\$9,070

EFFECTIVE OCTOBER 17, 2022

4. Conference Typical

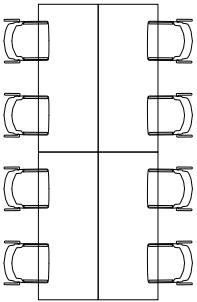
Category	Code	Quantity	Description	List Price	Ext Price	
Tabletop	3231 TBT9 TZ2460 TL27 GP00	4	Rectangular Tabletop: 24" x 60", Laminate, No Grommets	\$324	\$1,296	
Table Base	3232 TBT9 TZ2460 BF01	4	Base (Pairs With 24" x 60" Rectangular Tabletop)	\$580	\$2,320	
Accessories	3159 ATC03 XGV	4	Two Pairs of Ganging Brackets	\$50	\$200	
TOTAL:					\$3,816	

5. L-Shape Typical With Main Desk and Return

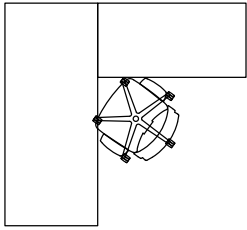
Category	Code	Quantity	Description	List Price	Ext Price	
Tabletop	3231 TBT9 TZ3072 TL27 GP00	1	Rectangular Tabletop: 30" x 72", Laminate, No Grommets	\$484	\$484	
Return Top	3231 TBT9P TN2448 TL27 GPR00	1	Return Top: 24" x 48", Laminate, No Grommets	\$261	\$261	
Table Base	3232 TBT9 TZ3072 BF01	1	Base (Pairs With 30" x 72" Rectangular Tabletop)	\$606	\$606	
Return Base	3232 TBT9P TN2448 BF01	1	Return Base (Pairs With 24" x 48" Return Top)	\$290	\$290	
TOTAL:					\$1,641	

6. U-Shape Typical With Bridge

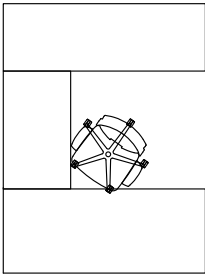
Category	Code	Quantity	Description	List Price	Ext Price	
Desktop	3231 TBT9 TZ3072 TL27 GP00	1	Rectangular Desktop: 30" x 72", Laminate, No Grommets	\$484	\$484	
Credenza Top	3231 TBT9 TZ2472 TL27 GP00	1	Rectangular Credenza Top: 24" x 72", Laminate, No Grommets	\$389	\$389	
Bridgetop	3231 TBT10 TZ2442 TL27	1	Bridgetop: 24" x 42", Laminate	\$229	\$229	
Desk Base	3232 TBT9 TZ3072 BF01	1	Base (Pairs With 30" x 72" Rectangular Tabletop)	\$606	\$606	
Credenza Base	3232 TBT9 TZ2472 BF01	1	Base (Pairs With 24" x 72" Rectangular Tabletop)	\$606	\$606	
Bridge Support	3232 TBT10 TZ2442	1	Mending Brackets (Pairs With 24" x 42" Bridgetop)	\$192	\$192	
TOTAL:					\$2,506	

Tensor

CAFÉ TABLE

One table does it all.

As your business grows and changes, your workspace should be able to keep up. That's why we created Tensor—one table that can adapt to your changing needs. It's the only table that can expand to support multiple top shapes and sizes with a single base. This allows you to install and reconfigure to fit any space quickly and easily.



Round Café Table
Chair sold separately; see [page 211](#) for Baja .

EFFECTIVE OCTOBER 17, 2022

Featured Models

SQUARE :: \$918

42" square tabletop, grade 1 laminate, matching base

ROUND :: \$918

42" round tabletop, grade 1 laminate, matching base

Features

- Patent-pending easy-to-size table support structure adapts to all spaces
- Steel dual-isosceles triangle design evenly distributes and supports weight throughout
- Base accommodates round and square tabletops
Round from 42"–48"; Square from 30"–48"
- Features a minimalistic aesthetic with a below-the-surface configuration
- 28 different durable laminate options to fit your style
- Assembles in less than 10 minutes with pre-installed parts
- 300 lb weight capacity warranty

SPECIFICATIONS

	Tensor Café Table
Height	29.67"
Leg Width	1.8"
Tabletop Thickness	1.125"
Weight Capacity Warranty	300 lb

Height range includes 1.125" tabletop.

See the Stand-Alone Tabletop appendix on page 588 for tabletop weights.

CAFÉ TABLETOP

TOPS AND BASES ARE SPECIFIED AND SOLD SEPARATELY.

1. Product

Product Type	Code	Price
Tabletop	3231 TBT9	Priced by Size

2. Finish

Laminate Color	Code	Price
Grade 1 Laminate		
Ankara Cherry	TL18	Priced by Grade
Black	TL19	Priced by Grade
Brazilian Walnut	TL20	Priced by Grade
Cabinet Maple	TL21	Priced by Grade
Driftwood	TL23	Priced by Grade
Folkstone Grey	TL24	Priced by Grade
Libretti	TL25	Priced by Grade
Queenston Oak	TL26	Priced by Grade
Sandalwood	TL27	Priced by Grade
Walnut Amati	TL28	Priced by Grade
White	TL29	Priced by Grade
Grade 2 Laminate		
Classic Linen	TL17	Priced by Grade
Colombian Walnut	TL55	Priced by Grade
Crisp Linen	TL64	Priced by Grade
Designer White	TL66	Priced by Grade
Field Elm	TL13	Priced by Grade
Frosty White	TL16	Priced by Grade
Grey	TL62	Priced by Grade
Grey Elm	TL51	Priced by Grade
Kingswood Walnut	TL53	Priced by Grade
Manitoba	TL56	Priced by Grade
Neo Walnut	TL50	Priced by Grade
Platinum	TL61	Priced by Grade
Portico Teak	TL60	Priced by Grade
Skyline Walnut	TL15	Priced by Grade
Steel Mesh	TL59	Priced by Grade
Tuscan Walnut	TL57	Priced by Grade
Uptown Walnut	TL14	Priced by Grade
Laminate Grade	Code	Price
Laminate Grade 1	GR1	Priced by Size
Laminate Grade 2	GR2	Priced by Size

EFFECTIVE OCTOBER 17, 2022

3. Shape

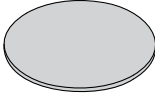
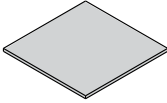
Tabletop Shape	Code	Price	
Round	TR	Priced by Size	
Square	TS	Priced by Size	

Actual size of 30" x 30" tabletop is 30.75" x 30.75".

CAFÉ TABLETOP

TOPS AND BASES ARE SPECIFIED AND SOLD SEPARATELY.

4. Size

Tabletop Size	Code	Price	
Round		Grade 1	Grade 2
42"	4242	\$385	\$578
48"	4848	\$458	\$687
Square		Grade 1	Grade 2
30"	3030	\$297	\$446
36"	3636	\$345	\$518
42"	4242	\$385	\$578
48"	4848	\$458	\$687

Actual size of 30" x 30" tabletop is 30.75" x 30.75".

Square Café Table

Chair sold separately; see page 251 for Mika.



EFFECTIVE OCTOBER 17, 2022

1. Product

Product Type	Code	Price
Base	3232 TBT9	\$533

2. Base Finish

Paint Color	Code	Price
Silver	BF01	+ \$0
White	BF02	+ \$0
Black	BF03	+ \$0

3. Size

Tabletop Size	Code	Price
No Tabletop	TZ0	+ \$0

Round	TR	+ \$0
-------	----	-------

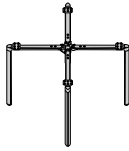

Square	TS	+ \$0
--------	----	-------

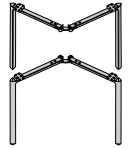

Table bases require the specification of a tabletop size. Bases take their size from their corresponding top size.

CAFÉ TABLE BASE

TOPS AND BASES ARE SPECIFIED AND SOLD SEPARATELY.

4. Size

Tabletop Size	Code	Price
No Tabletop	TZ0	+ \$0
Round		
42"	4242	+ \$0
48"	4848	+ \$0
Square		
30"	3030	+ \$0
36"	3636	+ \$0
42"	4242	+ \$0
48"	4848	+ \$0

Table bases require the specification of a tabletop size. Bases take their size from their corresponding top size.

Tensor

MULTIPURPOSE TABLE

One table does it all.

As your business grows and changes, your workspace should be able to keep up. That's why we created Tensor—one table that can adapt to your changing needs. It's the only table that can expand to support multiple top shapes and sizes with a single base. This allows you to install and reconfigure to fit any space quickly and easily.



24" x 60" Table

Chair sold separately; see [page 242](#) for Ioniq Multipurpose.

EFFECTIVE OCTOBER 17, 2022

Featured Models

18" x 48" :: \$780

18" x 48" tabletop, grade 1 laminate, no grommets, matching base

24" x 60" :: \$904

24" x 60" tabletop, grade 1 laminate, no grommets, matching base

30" x 72" :: \$1,090

30" x 72" tabletop, grade 1 laminate, matching base

Features

- Patent-pending easy-to-size table support structure adapts to all spaces
- Steel dual-isosceles triangle design evenly distributes and supports weight throughout
- Base accommodates tabletops from 18" (D) × 48" (W) to 30" (D) × 72" (W)
- Features a minimalistic aesthetic with a below-the-surface configuration
- 28 different durable laminate options to fit your style
- Installs in less than 10 minutes with pre-installed parts
- 300 lb weight capacity warranty

SPECIFICATIONS

	Tensor Multipurpose
Height	29.67"
Leg Width	1.8"
Tabletop Thickness	1.125"
Weight Capacity Warranty	300 lb

Height range includes 1.125" tabletop.

1. Product

Product Type	Code	Price
Tabletop	3231 TBT9	Priced by Size

2. Finish

Laminate Color	Code	Price
Grade 1 Laminate		
Ankara Cherry	TL18	Priced by Size
Black	TL19	Priced by Size
Brazilian Walnut	TL20	Priced by Size
Cabinet Maple	TL21	Priced by Size
Driftwood	TL23	Priced by Size
Folkstone Grey	TL24	Priced by Size
Libretti	TL25	Priced by Size
Queenston Oak	TL26	Priced by Size
Sandalwood	TL27	Priced by Size
Walnut Amati	TL28	Priced by Size
White	TL29	Priced by Size

MULTIPURPOSE TABLETOP

TOPS AND BASES ARE SPECIFIED AND SOLD SEPARATELY.

2. Finish (Cont.)

Laminate Color	Code	Price
Grade 2 Laminate		
Classic Linen	TL17	Priced by Size
Colombian Walnut	TL55	Priced by Size
Crisp Linen	TL64	Priced by Size
Designer White	TL66	Priced by Size
Field Elm	TL13	Priced by Size
Frosty White	TL16	Priced by Size
Grey	TL62	Priced by Size
Grey Elm	TL51	Priced by Size
Kingswood Walnut	TL53	Priced by Size
Manitoba	TL56	Priced by Size
Neo Walnut	TL50	Priced by Size
Platinum	TL61	Priced by Size
Portico Teak	TL60	Priced by Size
Skyline Walnut	TL15	Priced by Size
Steel Mesh	TL59	Priced by Size
Tuscan Walnut	TL57	Priced by Size
Uptown Walnut	TL14	Priced by Size
Laminate Grade	Code	Price
Laminate Grade 1	GR1	Priced by Size
Laminate Grade 2	GR2	Priced by Size

3. Shape

Tabletop Shape	Code	Price
Rectangular Tabletop	TZ	Priced by Size

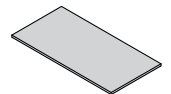

EFFECTIVE OCTOBER 17, 2022

MULTIPURPOSE TABLETOP

TOPS AND BASES ARE SPECIFIED AND SOLD SEPARATELY.

4. Size

Tabletop Size (D x W)	Code	Price	
Rectangular Tabletop		Grade 1	Grade 2
18" x 42"	TZ1842	\$176	\$264
18" x 48"	TZ1848	\$200	\$300
18" x 54"	TZ1854	\$225	\$338
18" x 60"	TZ1860	\$248	\$372
18" x 66"	TZ1866	\$275	\$413
18" x 72"	TZ1872	\$300	\$450
24" x 36"	TZ2436	\$196	\$294
24" x 42"	TZ2442	\$229	\$344
24" x 48"	TZ2448	\$261	\$392
24" x 54"	TZ2454	\$292	\$438
24" x 60"	TZ2460	\$324	\$486
24" x 66"	TZ2466	\$358	\$537
24" x 72"	TZ2472	\$389	\$584
30" x 36"	TZ3036	\$244	\$366
30" x 42"	TZ3042	\$285	\$428
30" x 48"	TZ3048	\$324	\$486
30" x 54"	TZ3054	\$366	\$549
30" x 60"	TZ3060	\$404	\$606
30" x 66"	TZ3066	\$445	\$668
30" x 72"	TZ3072	\$484	\$726

5. Grommets

Grommet Location	Code	Price	
None	GP00	+ \$0	
Left Only	GP01	+ \$30	
Center Only	GP02	+ \$30	
Right Only	GP03	+ \$30	
Left and Center	GP04	+ \$60	
Left and Right	GP05	+ \$60	
Right and Center	GP06	+ \$60	
Left, Right and Center	GP07	+ \$90	

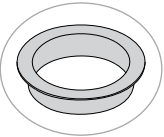

Grommet Color	Code	Price	
Black	GC01	+ \$0	
White	GC02	+ \$0	

EFFECTIVE OCTOBER 17, 2022

1. Product

Product Type	Code	Price
Table Base	3232 TBT9	\$533

3. Base Finish

Paint Color	Code	Price
Silver	BF01	+ \$0
White	BF02	+ \$0
Black	BF03	+ \$0

3. Matching Tabletop

Tabletop Size (D x W)	Code	Price
Rectangular Tabletop	TZ	+ \$0



Tabletop Size (D x W)	Code	Price
18" x 42"	1842	+ \$0
18" x 48"	1848	+ \$47
18" x 54"	1854	+ \$47
18" x 60"	1860	+ \$47
18" x 66"	1866	+ \$47
18" x 72"	1872	+ \$73
24" x 36"	2436	+ \$0
24" x 42"	2442	+ \$0
24" x 48"	2448	+ \$47
24" x 54"	2454	+ \$47
24" x 60"	2460	+ \$47
24" x 66"	2466	+ \$47
24" x 72"	2472	+ \$73
30" x 36"	3036	+ \$0
30" x 42"	3042	+ \$0
30" x 48"	3048	+ \$47
30" x 54"	3054	+ \$47
30" x 60"	3060	+ \$47
30" x 66"	3066	+ \$47
30" x 72"	3072	+ \$73

Table bases require the specification of a tabletop size. Bases take their size from their corresponding top size.

MULTIPURPOSE TABLE BASE

TOPS AND BASES ARE SPECIFIED AND SOLD SEPARATELY.

1. Additional Options (Sold Separately)

Ganging	Code	Price
Two Pairs of Ganging Brackets	3159 XGV	\$50



Tensor

DESKING

One table does it all.

As your business grows and changes, your workspace should be able to keep up. That's why we created Tensor—one table that can adapt to your changing needs. It's the only table that can expand to support multiple top shapes and sizes with a single base. This allows you to install and reconfigure to fit any space quickly and easily.



EFFECTIVE OCTOBER 17, 2022

Featured Models

L-SHAPE DESK :: \$1,641

30" x 72" rectangular desktop, 24" x 48" return top, grade 1 laminate, no grommets, matching bases

U-SHAPE DESK :: \$2,506

30" x 72" desktop, 24" x 72" credenza tops, no grommets, 24" x 42" bridgetop, grade 1 laminate, matching bases and bridge support

Features

- Patent-pending easy-to-size table support structure adapts to all spaces
- Steel dual-isosceles triangle design evenly distributes and supports weight throughout
- Accommodates desktops from 24" x 54"-30" x 72"; credenzas from 18" x 54"-30" x 72"; 24" x 36"-60"
- Features a minimalistic aesthetic with a below-the-surface configuration
- 28 different durable laminate options to fit your style
- Installs in less than 10 minutes with pre-installed parts
- 300 lb weight capacity warranty

SPECIFICATIONS

	Tensor Desking
Height	29.67"
Leg Width	1.8"
Tabletop Thickness	1.125"
Weight Capacity Warranty	300 lb

Height range includes 1.125" tabletop.

See the Stand-Alone Tabletop appendix on [page 588](#) for tabletop weights.



U-Shape Desk
 Chair sold separately;
 see [page 127](#) for Novo.

1. Product

Product Type	Code	Price
Desktop	3231 TBT9	Priced by Size

2. Finish

Laminate Color	Code	Price
Grade 1 Laminate		
Ankara Cherry	TL18	Priced by Size
Black	TL19	Priced by Size
Brazilian Walnut	TL20	Priced by Size
Cabinet Maple	TL21	Priced by Size
Driftwood	TL23	Priced by Size
Folkstone Grey	TL24	Priced by Size
Libretti	TL25	Priced by Size
Queenston Oak	TL26	Priced by Size
Sandalwood	TL27	Priced by Size
Walnut Amati	TL28	Priced by Size
White	TL29	Priced by Size
Grade 2 Laminate		
Classic Linen	TL17	Priced by Size
Colombian Walnut	TL55	Priced by Size
Crisp Linen	TL64	Priced by Size
Designer White	TL66	Priced by Size
Field Elm	TL13	Priced by Size
Frosty White	TL16	Priced by Size
Grey	TL62	Priced by Size
Grey Elm	TL51	Priced by Size
Kingswood Walnut	TL53	Priced by Size
Manitoba	TL56	Priced by Size
Neo Walnut	TL50	Priced by Size
Platinum	TL61	Priced by Size
Portico Teak	TL60	Priced by Size
Skyline Walnut	TL15	Priced by Size
Steel Mesh	TL59	Priced by Size
Tuscan Walnut	TL57	Priced by Size
Uptown Walnut	TL14	Priced by Size
Laminate Grade	Code	Price
Laminate Grade 1	GR1	Priced by Size
Laminate Grade 2	GR2	Priced by Size

DESKTOP AND DESK BASE FOR L-SHAPE OR U-SHAPE

TOPS AND BASES ARE SPECIFIED AND SOLD SEPARATELY.

2. Size

Desktop Size (D x W)	Code	Price
Rectangular Desktop	TZ	Priced by Size

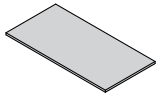

3. Size

Desktop Size (D x W)	Code	Laminate Price	
		Grade 1	Grade 2
Rectangular Desktop			
24" x 54"	2454	\$292	\$438
24" x 60"	2460	\$324	\$486
24" x 66"	2466	\$358	\$537
24" x 72"	2472	\$389	\$584
30" x 54"	3054	\$366	\$549
30" x 60"	3060	\$404	\$606
30" x 66"	3066	\$445	\$668
30" x 72"	3072	\$484	\$726

4. Grommets

Grommet Location	Code	Price
None	GP00	+ \$0
Left Only	GP01	+ \$30
Center Only	GP02	+ \$30
Right Only	GP03	+ \$30
Left and Center	GP04	+ \$60
Left and Right	GP05	+ \$60
Right and Center	GP06	+ \$60
Left, Right and Center	GP07	+ \$90
Grommet Color	Code	Price
Black	GC01	+ \$0
White	GC02	+ \$0

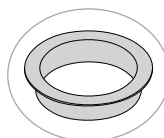

1. Desk Base

Product Type	Code	Price
Base	3232 TBT9	\$533

2. Size

Desktop Size (D x W)	Code	Price
24" x 54"	TZ2454	\$47
24" x 60"	TZ2460	\$47
24" x 66"	TZ2466	\$47
24" x 72"	TZ2472	\$73
30" x 54"	TZ3054	\$47
30" x 60"	TZ3060	\$47
30" x 66"	TZ3066	\$47
30" x 72"	TZ3072	\$73



Desk bases require the specification of a desktop size. Bases take their size from their corresponding top size.

3. Base Finish

Paint Color	Code	Price
Silver	BF01	+ \$0
White	BF02	+ \$0
Black	BF03	+ \$0

1. Product

Product Type	Code	Size
Return Top	3231 TBT9P	Priced by Size

2. Finish

Laminate Color	Code	Price
Grade 1 Laminate		
Ankara Cherry	TL18	Priced by Size
Black	TL19	Priced by Size
Brazilian Walnut	TL20	Priced by Size
Cabinet Maple	TL21	Priced by Size
Driftwood	TL23	Priced by Size
Folkstone Grey	TL24	Priced by Size
Libretti	TL25	Priced by Size
Queenston Oak	TL26	Priced by Size
Sandalwood	TL27	Priced by Size
Walnut Amati	TL28	Priced by Size
White	TL29	Priced by Size
Grade 2 Laminate		
Classic Linen	TL17	Priced by Size
Colombian Walnut	TL55	Priced by Size
Crisp Linen	TL64	Priced by Size
Designer White	TL66	Priced by Size
Field Elm	TL13	Priced by Size
Frosty White	TL16	Priced by Size
Grey	TL62	Priced by Size
Grey Elm	TL51	Priced by Size
Kingswood Walnut	TL53	Priced by Size
Manitoba	TL56	Priced by Size
Neo Walnut	TL50	Priced by Size
Platinum	TL61	Priced by Size
Portico Teak	TL60	Priced by Size
Skyline Walnut	TL15	Priced by Size
Steel Mesh	TL59	Priced by Size
Tuscan Walnut	TL57	Priced by Size
Uptown Walnut	TL14	Priced by Size
Laminate Grade	Code	Price
Laminate Grade 1	GR1	Priced by Size
Laminate Grade 2	GR2	Priced by Size

RETURN TOP FOR L-SHAPE OR U-SHAPE TOPS AND BASES ARE SPECIFIED AND SOLD SEPARATELY.

3. Shape

Return Top Size (D x W)	Code	Price
Rectangular Return Top	TN	Priced by Size

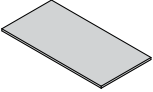

4. Size

Return Top Size (D x W)	Code	Laminate Price	
Rectangular Return Top		Grade 1	Grade 2
24" x 36"	2436	\$196	\$294
24" x 42"	2442	\$229	\$344
24" x 48"	2448	\$261	\$392
24" x 54"	2454	\$292	\$438
24" x 60"	2460	\$324	\$486

5. Grommets

Grommet Location	Code	Price
None	GPR00	+ \$0
Left Only	GPR01	+ \$30
Center Only	GPR02	+ \$30
Right Only	GPR03	+ \$30



Grommet Color	Code	Price
Black	GC01	+ \$0
White	GC02	+ \$0

EFFECTIVE OCTOBER 17, 2022

1. Product

Product Type	Code	Price
Return Base	3232 TBT9P	\$290

2. Size

Return Top Size (D x W)	Code	Price
No Return Top	TN0	+ \$0
24" x 36"	TN2436	+ \$0
24" x 42"	TN2442	+ \$0
24" x 48"	TN2448	+ \$0
24" x 54"	TN2454	+ \$74
24" x 60"	TN2460	+ \$74

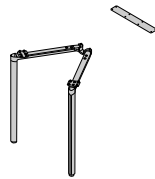

Return bases require the specification of a return top size.

3. Base Finish

Paint Color	Code	Price
Silver	BF01	\$0
White	BF02	\$0
Black	BF03	\$0

EFFECTIVE OCTOBER 17, 2022

1. Product

Product Type	Code	Price
Bridge Top	3231 TBT10	Priced by Size

2. Finish

Laminate Color	Code	Price
Grade 1 Laminate		
Ankara Cherry	TL18	Priced by Size
Black	TL19	Priced by Size
Brazilian Walnut	TL20	Priced by Size
Cabinet Maple	TL21	Priced by Size
Driftwood	TL23	Priced by Size
Folkstone Grey	TL24	Priced by Size
Libretti	TL25	Priced by Size
Queenston Oak	TL26	Priced by Size
Sandalwood	TL27	Priced by Size
Walnut Amati	TL28	Priced by Size
White	TL29	Priced by Size
Grade 2 Laminate		
Classic Linen	TL17	Priced by Size
Colombian Walnut	TL55	Priced by Size
Crisp Linen	TL64	Priced by Size
Designer White	TL66	Priced by Size
Field Elm	TL13	Priced by Size
Frosty White	TL16	Priced by Size
Grey	TL62	Priced by Size
Grey Elm	TL51	Priced by Size
Kingswood Walnut	TL53	Priced by Size
Manitoba	TL56	Priced by Size
Neo Walnut	TL50	Priced by Size
Platinum	TL61	Priced by Size
Portico Teak	TL60	Priced by Size
Skyline Walnut	TL15	Priced by Size
Steel Mesh	TL59	Priced by Size
Tuscan Walnut	TL57	Priced by Size
Uptown Walnut	TL14	Priced by Size
Laminate Grade	Code	Price
Laminate Grade 1	GR1	Priced by Size
Laminate Grade 2	GR2	Priced by Size

BRIDGE TOP FOR U-SHAPE

TOPS AND BASES ARE SPECIFIED AND SOLD SEPARATELY.

3. Shape

Return Top Size (D x W)	Code	Price
Rectangular Bridge Top	TZ	Priced by Size

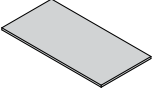

4. Size

Bridgetop Size (D x W)	Code	Price	
Rectangular Bridge Top		Grade 1	Grade 2
24" x 36"	2436	\$196	\$294
24" x 42"	2442	\$229	\$344
24" x 48"	2448	\$261	\$392
24" x 54"	2454	\$292	\$438
24" x 60"	2460	\$324	\$486

EFFECTIVE OCTOBER 17, 2022

1. Product

Product Type	Code	Price
Bridge Support (Mending Brackets)	3232 TBT10	Priced by Size

2. Size

Bridge Top Shape	Code	Price
Rectangular Bridge Top	TZ	\$0

Bridge Top Size (D x W)	Code	Price
No Bridge Top	TN0	\$0
24" x 36"	2436	\$192
24" x 42"	2442	\$192
24" x 48"	2448	\$192
24" x 54"	2454	\$294
24" x 60"	2460	\$294

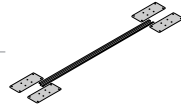

Support includes two sets of mending brackets for all bridge sizes. 54" and 60" table widths also include stiffener.

Bridge supports require the specification of a bridge top size.

EFFECTIVE OCTOBER 17, 2022

1. Product

Product Type	Code	Price
Credenza Top	3231 TBT9	Priced by Size

2. Finish

Laminate Color	Code	Price
Grade 1 Laminate		
Ankara Cherry	TL18	Priced by Size
Black	TL19	Priced by Size
Brazilian Walnut	TL20	Priced by Size
Cabinet Maple	TL21	Priced by Size
Driftwood	TL23	Priced by Size
Folkstone Grey	TL24	Priced by Size
Libretti	TL25	Priced by Size
Queenston Oak	TL26	Priced by Size
Sandalwood	TL27	Priced by Size
Walnut Amati	TL28	Priced by Size
White	TL29	Priced by Size
Grade 2 Laminate		
Classic Linen	TL17	Priced by Size
Colombian Walnut	TL55	Priced by Size
Crisp Linen	TL64	Priced by Size
Designer White	TL66	Priced by Size
Field Elm	TL13	Priced by Size
Frosty White	TL16	Priced by Size
Grey	TL62	Priced by Size
Grey Elm	TL51	Priced by Size
Kingswood Walnut	TL53	Priced by Size
Manitoba	TL56	Priced by Size
Neo Walnut	TL50	Priced by Size
Platinum	TL61	Priced by Size
Portico Teak	TL60	Priced by Size
Skyline Walnut	TL15	Priced by Size
Steel Mesh	TL59	Priced by Size
Tuscan Walnut	TL57	Priced by Size
Uptown Walnut	TL14	Priced by Size
Laminate Grade	Code	Price
Laminate Grade 1	GR1	Priced by Size
Laminate Grade 2	GR2	Priced by Size

CREENZA TOP FOR U-SHAPE

TOPS AND BASES ARE SPECIFIED AND SOLD SEPARATELY.

3. Shape

Credenza Shape	Code	Price
Rectangular Credenza Top	TZ	Priced by Size

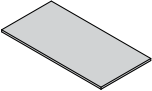

4. Size

Credenza Top Size (D x W)	Code	Laminate Price	
Rectangular Bridge Top		Grade 1	Grade 2
18" x 54"	1854	\$225	\$338
18" x 60"	1860	\$248	\$372
18" x 66"	1866	\$275	\$413
18" x 72"	1872	\$300	\$450
24" x 54"	2454	\$292	\$438
24" x 60"	2460	\$324	\$486
24" x 66"	2466	\$358	\$537
24" x 72"	2472	\$389	\$584
30" x 54"	3054	\$366	\$549
30" x 60"	3060	\$404	\$606
30" x 66"	3066	\$445	\$668
30" x 72"	3072	\$484	\$726

5. Grommets

Grommet Location	Code	Price
No Grommets	GP00	+ \$0
Left Only	GP01	+ \$30
Center Only	GP02	+ \$30
Right Only	GP03	+ \$30
Left and Center	GP04	+ \$60
Left and Right	GP05	+ \$60
Right and Center	GP06	+ \$60
Left, Right and Center	GP07	+ \$90
Grommet Color	Code	Price
Black	GC01	+ \$0
White	GC02	+ \$0

EFFECTIVE OCTOBER 17, 2022

1. Product

Product Type	Code	Price
Credenza Base	3232 TBT9	\$533

2. Base Finish

Paint Color	Code	Price
Silver	BF01	+ \$0
White	BF02	+ \$0
Black	BF03	+ \$0

3. Size

Credenza Top Size (D x W)	Code	Price
18" x 54"	TZ1854	+ \$47
18" x 60"	TZ1860	+ \$47
18" x 66"	TZ1866	+ \$47
18" x 72"	TZ1872	+ \$73
24" x 54"	TZ2454	+ \$47
24" x 60"	TZ2460	+ \$47
24" x 66"	TZ2466	+ \$47
24" x 72"	TZ2472	+ \$73
30" x 54"	TZ3054	+ \$47
30" x 60"	TZ3060	+ \$47
30" x 66"	TZ3066	+ \$47
30" x 72"	TZ3072	+ \$73



Credenza bases require the specification of a credenza top size. Bases take their size from their corresponding top size.

Uni

LAPTOP TABLE

Uni-quely Uni-versal.

Light in weight and not on convenience.

Uni goes anywhere you need it—and with any lounge collection we have. Laptops, notebooks, coffee mugs and more, it's the perfect seating sidekick for your shared and in-between spaces.



EFFECTIVE OCTOBER 17, 2022

Featured Models

CHARCOAL :: \$522

Rectangular laptop table, charcoal base, laminate top

SILVER :: \$522

Rectangular laptop table, charcoal base, laminate top

Features

- Ample surface provides plenty of room to work
- Sleek laminate top features a low-profile knife edge
- Easy-grip finger groove makes moving easy
- Durable base is ultra slim for safer high-traffic areas
- Multi-surface glides enhance mobility while protecting floors
- 100 lb weight capacity warranty

1. Product

Model	Code	Price	
Rectangular Laptop Table	3260 TT9	\$522	

2. Base

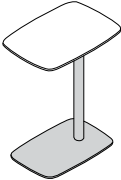
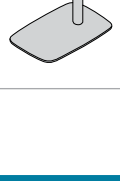
Base Color	Code	Price	
Charcoal	BF04	+ \$0	
Silver	BF01	+ \$0	

3. Table Top

Material	Code	Price	
Laminate	TM3	+ \$0	
Material	Code	Price	
Field Elm	TL13	+ \$0	
Uptown Walnut	TL14	+ \$0	
Skyline Walnut	TL15	+ \$0	
Frosty White	TL16	+ \$0	

LAPTOP TABLE

4. Packaging

Packaging	Code	Price	
Final Assembly Required	P3	+ \$0	

SPECIFICATIONS

Model: 3260 TT9 Laptop Table	
Dimensions	
Overall Height	25.5"
Tabletop Depth	14"
Tabletop Width	20"
Tabletop Thickness	0.75"
Base Depth	11.6"
Base Width	17.6"
Base Thickness	0.25"
Weight and Capacity	
Weight	23.63 lb
Weight Capacity Warranty	100 lb



Charcoal

Benching

FIXED | SINGLE-SIDED | BACK-TO-BACK

HiQ

HEIGHT-ADJUSTABLE BENCHING

Elevate your spaces—literally

HiQ™ is our brand-new height-adjustable total benching solution. This collection lets you take productivity to a higher level with the push of a button, promoting healthier environments through essential ergonomics, connectivity and workspace division. And with a vast lineup of options and add-ons, there's no limit to how you can make it fit anywhere.



6-Seat With Screen
Chairs and storage sold separately.
See [page 127](#) for Novo and [page 576](#) for Mobile pedestal.

EFFECTIVE OCTOBER 17, 2022

Featured Models

BASIC 4-SEAT :: \$7,376

Four seat back-to-back base, 70" x 23" bench tops with no grommets and a grade 1 laminate, vertical wire manager, no end panels, no wire troughs, 72" power infeed, conduit, two duplex receptacles per seat

6-SEAT WITH SCREEN :: \$14,244

Six seat back-to-back base, 70" x 23" bench tops with no grommets and a grade 2 laminate, vertical wire manager, no end panels, no wire troughs, 72" power infeed, conduit, three duplex receptacles per seat, 18" x 72" screens in a grade 2 textile

BENCH TOP

TOPS AND BASES ARE SPECIFIED AND SOLD SEPARATELY.

Features

- Take ergonomics to a new level with push-button height adjustability (28"–47")
- Add a little privacy in shared setups with any Sector or Motif screen as well as optional laminate gallery panels
- Build powerful places of productivity with a robust roster of workstation accessories
- Clear the clutter using cable, data and power management enhancements (beam or trough)
- Customize buildouts to fit your corporate, healthcare and education environments
- Standard control includes four programmable positions and features integrated gyroscopic anti-collision sensor
- Maximize power and data access with up to six duplexes per workstation and capacity for up to 48 CAT6 cables
- Make setup seamless with "above-beam" power and data installation
- Robust steel construction exceeds BIFMA standards for safety and reliability
- UL Certified (UL932)



SPECIFICATIONS

	3291/3292 Height-Adjustable Benching
Total Depth of Benches	50" (24" Top) 62" (30" Top)
Space Between Back-to-Back Benches	4"
Bench Top Thickness	1.125"
Side-to-Side Gap (Mid-Run)	2"
Height Without Bench Top	27.5"–46.4"
Height From Floor to Underside of Crossbeam	17.29"
Distance Between Legs (Width) (Inside-Edge-to-Inside-Edge End)	37.4" (48" Top) 49.4" (60" Top) 61.4" (72" Top)
Distance Between Legs (Width) (Outside-Edge-to-Outside-Edge)	42.9" (48" Top) 54.9" (60" Top) 66.9" (72" Top)
Leg (sq)	2.75"
Crossbeam (H x W)	3.2" x 2.6"
Guage of Steel	12
Active Power Consumption	190–200 W
Standby Power Consumption	0.1 W
Travel Height	19.7"
Speed (Per Second)	1.2"
Weight Capacity (Per Seat)	265 lb



Standard 4-Seat

1. Product

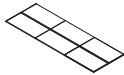
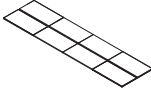
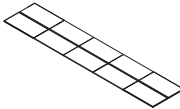
Product Type	Code	Price	
HiQ Bench Top	3291	Priced by Size	
Orientation	Code	Price	
Back-to-Back	BB	Priced by Size	
Seated Positions	Code	Price	
Back-to-Back			
Two Seats	SP2	Priced by Size	
Four Seats	SP4	Priced by Size	
Six Seats	SP6	Priced by Size	
Eight Seats	SP8	Priced by Size	
Ten Seats	SP10	Priced by Size	
Matching Base Style	Code	Price	
2-Stage T-Leg	TBT5	Priced by Size	

2. Finish

Laminate	Code	Price	
Grade 1 Laminate			
Ankara Cherry	TL18	Priced by Size	
Black	TL19	Priced by Size	
Brazilian Walnut	TL20	Priced by Size	
Cabinet Maple	TL21	Priced by Size	
Driftwood	TL23	Priced by Size	
Folkstone Grey	TL24	Priced by Size	
Libretti	TL25	Priced by Size	
Queenston Oak	TL26	Priced by Size	
Sandalwood	TL27	Priced by Size	

BENCH TOP

TOPS AND BASES ARE SPECIFIED AND SOLD SEPARATELY.

3. Top Finish

Laminate	Code	Price	
Walnut Amati	TL28	Priced by Size	
White	TL29	Priced by Size	
Grade 2 Laminate			
Classic Linen	TL17	Priced by Size	
Colombian Walnut	TL55	Priced by Size	
Crisp Linen	TL64	Priced by Size	
Designer White	TL66	Priced by Size	
Field Elm	TL13	Priced by Size	
Frosty White	TL16	Priced by Size	
Grey	TL62	Priced by Size	
Grey Elm	TL51	Priced by Size	
Kingswood Walnut	TL53	Priced by Size	
Manitoba	TL56	Priced by Size	
Neo Walnut	TL50	Priced by Size	
Platinum	TL61	Priced by Size	
Portico Teak	TL60	Priced by Size	
Skyline Walnut	TL15	Priced by Size	
Steel Mesh	TL59	Priced by Size	
Tuscan Walnut	TL57	Priced by Size	
Uptown Walnut	TL14	Priced by Size	
Laminate Grade	Code	Price	
Laminate Grade 1	GR1	Priced by Size	
Laminate Grade 2	GR2	Priced by Size	

3. Shape

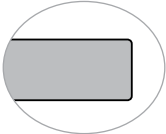
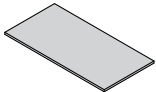
Edge Style	Code	Price	
Flat Edge	TE5	Priced by Size	
Bench Top Shape	Code	Price	
Rectangular Bench Top	TZ	Priced by Size	

4. Size

Depth x Width	Code	Laminate Price	
Two Seat (BB)		Grade 1	Grade 2
23" x 46"	2346	\$522	\$784
23" x 58"	2358	\$648	\$972
23" x 70"	2370	\$778	\$1,168
29" x 46"	2946	\$648	\$972
29" x 58"	2958	\$808	\$1,212
29" x 70"	2970	\$968	\$1,452
Four Seats (BB)		Grade 1	Grade 2
23" x 46"	2346	\$1,044	\$1,568
23" x 58"	2358	\$1,296	\$1,944
23" x 70"	2370	\$1,556	\$2,336
29" x 46"	2946	\$1,296	\$1,944
29" x 58"	2958	\$1,616	\$2,424
29" x 70"	2970	\$1,936	\$2,904
Six Seats (BB)		Grade 1	Grade 2
23" x 46"	2346	\$1,566	\$2,352
23" x 58"	2358	\$1,944	\$2,916
23" x 70"	2370	\$2,334	\$3,504
29" x 46"	2946	\$1,944	\$2,916
29" x 58"	2958	\$2,424	\$3,636
29" x 70"	2970	\$2,904	\$4,356
Eight Seats (BB)		Grade 1	Grade 2
23" x 46"	2346	\$2,088	\$3,136
23" x 58"	2358	\$2,592	\$3,888
23" x 70"	2370	\$3,112	\$4,672
29" x 46"	2946	\$2,592	\$3,888
29" x 58"	2958	\$3,232	\$4,848
29" x 70"	2970	\$3,872	\$5,808
Ten Seats (BB)		Grade 1	Grade 2
23" x 46"	2346	\$2,610	\$3,920
23" x 58"	2358	\$3,240	\$4,860
23" x 70"	2370	\$3,890	\$5,840
29" x 46"	2946	\$3,240	\$4,860
29" x 58"	2958	\$4,040	\$6,060
29" x 70"	2970	\$4,840	\$7,260



BENCH TOP

TOPS AND BASES ARE SPECIFIED AND SOLD SEPARATELY.

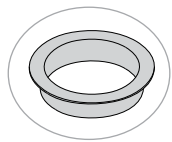
5. Grommets

Grommet Location	Code	Price	
None	GP00	+ \$0	
Two Seat (BB)			
Left	GP01	+ \$60	
Right	GP03	+ \$60	
Left and Right	GP05	+ \$120	
Four Seats (BB)			
Left	GP01	+ \$120	
Right	GP03	+ \$120	
Left and Right	GP05	+ \$240	
Six Seats (BB)			
Left	GP01	+ \$180	
Right	GP03	+ \$180	
Left and Right	GP05	+ \$360	
Eight Seats (BB)			
Left	GP01	+ \$240	
Right	GP03	+ \$240	
Left and Right	GP05	+ \$480	
Ten Seats (BB)			
Left	GP01	+ \$300	
Right	GP03	+ \$300	
Left and Right	GP05	+ \$600	
Grommet Color	Code	Price	
Black	GC01	+ \$0	
White	GC02	+ \$0	

1. Product

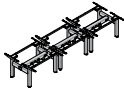
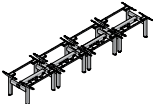
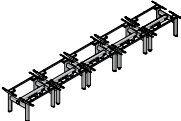
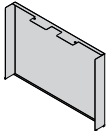
Product Type	Code	Price	
HA Bench Bases	3292	Priced by Style	
Orientation	Code	Price	
Back-to-Back	BB	Priced by Style	
Seated Postions	Code	Price	
Back-to-Back			
Two Seats	SP2	Priced by Style	
Four Seats	SP4	Priced by Style	
Six Seats	SP6	Priced by Style	
Eight Seats	SP8	Priced by Style	
Ten Seats	SP10	Priced by Style	
Base Style	Code	Price	
2-Stage Height-Adjustable			
Two Seats (BB)	TBT5	\$3,210	
Four Seats (BB)	TBT5	\$6,420	
Six Seats (BB)	TBT5	\$9,630	
Eight Seats (BB)	TBT5	\$12,840	
Ten Seats (BB)	TBT5	\$16,050	
Optional Base Components	Code	Price	
No End Panels	FEK00	+ \$0	
End Panel Set	FEK02	+ \$348	

BENCH BASE

TOPS AND BASES ARE SPECIFIED AND SOLD SEPARATELY.

2. Matching Tabletop

Tabletop Shape	Code	Price	
Rectangular	TZ	+ \$0	
Tabletop Size			
23" x 46"	2346	+ \$0	
23" x 58"	2358	+ \$0	
23" x 70"	2370	+ \$0	
29" x 46"	2946	+ \$0	
29" x 58"	2958	+ \$0	
29" x 70"	2970	+ \$0	

Bench bases require the specification of a bench top size. Bases take their size from their corresponding top size.

3. Hand Control

Hand Control Style	Code	Price	
Programmable Controller	HC02	+ \$0	

4. Cable Management

Cable Trough	Code	Price	
Cable Trough	CT00	+\$0	
No Cable Trough, Two Seats (BB)	CT01	- \$300	
No Cable Trough, Four Seats (BB)	CT01	- \$600	
No Cable Trough, Six Seats (BB)	CT01	- \$900	
No Cable Trough, Eight Seats (BB)	CT01	- \$1,200	
No Cable Trough, Ten Seats (BB)	CT01	- \$1,500	

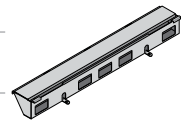

Vertical Wire Manager	Code	Price	
Vertical Wire Manager	VC01 VCC03	+ \$0	
No Vertical Cable Carrier, Two Seats (BB)	VC00	- \$210	
No Vertical Cable Carrier, Four Seats (BB)	VC00	- \$420	
No Vertical Cable Carrier, Six Seats (BB)	VC00	- \$630	
No Vertical Cable Carrier, Eight Seats (BB)	VC00	- \$840	
No Vertical Cable Carrier, Ten Seats (BB)	VC00	- \$1,050	

EFFECTIVE OCTOBER 17, 2022

4. Power

Power Infeed	Code	Price
No Power Infeed	NPIF	- \$147
72" Power Infeed, Conduit	PIC72	+ \$0
72" Power Infeed, Liquidtight	PIL72	+ \$12
144" Power Infeed, Conduit	PIC144	+ \$47
144" Power Infeed, Liquidtight	PIL144	+ \$59

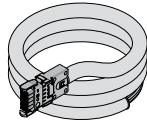

Vertical Cable Carrier	Code	Price
No Duplex		
No Duplex Receptacles, Two Seats (BB)	NDUP	- \$158
No Duplex Receptacles, Four Seats (BB)	NDUP	- \$316
No Duplex Receptacles, Six Seats (BB)	NDUP	- \$474
No Duplex Receptacles, Eight Seats (BB)	NDUP	- \$632
No Duplex Receptacles, Ten Seats (BB)	NDUP	- \$790

Double Duplex		
Double Duplex Receptacles	SDUP	+ \$0

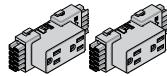

Triple Duplex		
Triple Duplex Receptacles, Two Seats (BB)	SDUP3	+ \$80
Triple Duplex Receptacles, Four Seats (BB)	SDUP3	+ \$160
Triple Duplex Receptacles, Six Seats (BB)	SDUP3	+ \$240
Triple Duplex Receptacles, Eight Seats (BB)	SDUP3	+ \$320
Triple Duplex Receptacles, Ten Seats (BB)	SDUP3	+ \$400

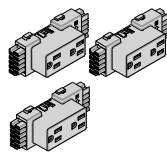

5. Base Finish

Paint Color	Code	Price
Silver	BF01	+ \$0
White	BF02	+ \$0
Black	BF03	+ \$0

SCREENS

1. Product

Product Type	Code	Price
HiQ Center Screen	3293	Priced By Screen Size

2. Matching Benching

Orientation	Code	Price
Back-to-Back	BB	Priced By Screen Size

Seated Positions	Code	Price
Back-to-Back		

Two Seats	SP2	Priced by Screen Size
Four Seats	SP4	Priced by Screen Size
Six Seats	SP6	Priced by Screen Size
Eight Seats	SP8	Priced by Screen Size
Ten Seats	SP10	Priced by Screen Size

Bench Top Size	Code	Price
None	TZ0	Priced by Screen Size
23" x 46"	TZ2346	Priced by Screen Size
23" x 58"	TZ2358	Priced by Screen Size
23" x 70"	TZ2370	Priced by Screen Size
29" x 46"	TZ2946	Priced by Screen Size
29" x 58"	TZ2958	Priced by Screen Size
29" x 70"	TZ2970	Priced by Screen Size

Screens require the specification of a bench top size.

3. Size

Screen Size (H" x W")	Code	Price
Two-Seat Back-to-Back		
18" x 48"	DS1848	Priced by Material and Grade
24" x 48"	DS2448	Priced by Material and Grade
30" x 48"	DS3048	Priced by Material and Grade
36" x 48"	DS3648	Priced by Material and Grade
18" x 60"	DS1860	Priced by Material and Grade
24" x 60"	DS2460	Priced by Material and Grade
30" x 60"	DS3060	Priced by Material and Grade
36" x 60"	DS3660	Priced by Material and Grade
18" x 72"	DS1872	Priced by Material and Grade
24" x 72"	DS2472	Priced by Material and Grade
30" x 72"	DS3072	Priced by Material and Grade
36" x 72"	DS3672	Priced by Material and Grade

4. Material

Material Type	Code	Price
Markerboard	DT301	Price Below
Fabric/Vinyl	DT701	Priced by Grade

Material Grade	Code	18" (H) Price	24" (H) Price	30" (H) Price	36" (H) Price
48" Wide Side Screens, Two-Seat Back-to-Back		18" x 48"	24" x 48"	30" x 48"	36" x 48"
Markerboard Price		\$316	\$421	\$509	\$636
Fabric/Vinyl Base Price		\$446	\$483	\$610	\$763
Fabric/Vinyl Grade 1	FG1/VG1	+ \$0	+ \$0	+ \$0	+ \$0
Fabric/Vinyl Grade 2	FG2/VG2	+ \$17	+ \$34	+ \$34	+ \$42
Fabric/Vinyl Grade 3	FG3/VG3	+ \$45	+ \$90	+ \$90	+ \$112
Fabric/Vinyl Grade 4	FG4/VG4	+ \$79	+ \$158	+ \$158	+ \$196
Fabric/Vinyl Grade 5	FG5/VG5	+ \$136	+ \$272	+ \$272	+ \$336

EFFECTIVE OCTOBER 17, 2022

4. Material (Cont.)

Material Grade	Code	18" (H) Price	24" (H) Price	30" (H) Price	36" (H) Price
48" Wide Side Screens, Four-Seat Back-to-Back		18" x 48"	24" x 48"	30" x 48"	36" x 48"
Markerboard Price		\$632	\$842	\$1,018	\$1,273
Fabric/Vinyl Base Price		\$892	\$966	\$1,220	\$1,525
Fabric/Vinyl Grade 1	FG1/VG1	+ \$0	+ \$0	+ \$0	+ \$0
Fabric/Vinyl Grade 2	FG2/VG2	+ \$34	+ \$68	+ \$68	+ \$84
Fabric/Vinyl Grade 3	FG3/VG3	+ \$90	+ \$180	+ \$180	+ \$224
Fabric/Vinyl Grade 4	FG4/VG4	+ \$158	+ \$316	+ \$316	+ \$392
Fabric/Vinyl Grade 5	FG5/VG5	+ \$272	+ \$544	+ \$544	+ \$672
48" Wide Side Screens, Six-Seat Back-to-Back		18" x 48"	24" x 48"	30" x 48"	36" x 48"
Markerboard Price		\$948	\$1,263	\$1,527	\$1,909
Fabric/Vinyl Base Price		\$1,338	\$1,449	\$1,830	\$2,288
Fabric/Vinyl Grade 1	FG1/VG1	+ \$0	+ \$0	+ \$0	+ \$0
Fabric/Vinyl Grade 2	FG2/VG2	+ \$51	+ \$102	+ \$102	+ \$126
Fabric/Vinyl Grade 3	FG3/VG3	+ \$135	+ \$270	+ \$270	+ \$336
Fabric/Vinyl Grade 4	FG4/VG4	+ \$237	+ \$474	+ \$474	+ \$588
Fabric/Vinyl Grade 5	FG5/VG5	+ \$408	+ \$816	+ \$816	+ \$1,008
48" Wide Side Screens, Eight-Seat Back-to-Back		18" x 48"	24" x 48"	30" x 48"	36" x 48"
Markerboard Price		\$1,264	\$1,684	\$2,036	\$2,545
Fabric/Vinyl Base Price		\$1,784	\$1,932	\$2,440	\$3,050
Fabric/Vinyl Grade 1	FG1/VG1	+ \$0	+ \$0	+ \$0	+ \$0
Fabric/Vinyl Grade 2	FG2/VG2	+ \$68	+ \$136	+ \$136	+ \$168
Fabric/Vinyl Grade 3	FG3/VG3	+ \$180	+ \$360	+ \$360	+ \$448
Fabric/Vinyl Grade 4	FG4/VG4	+ \$316	+ \$632	+ \$632	+ \$784
Fabric/Vinyl Grade 5	FG5/VG5	+ \$544	+ \$1,088	+ \$1,088	+ \$1,344
48" Wide Side Screens, Ten-Seat Back-to-Back		18" x 48"	24" x 48"	30" x 48"	36" x 48"
Markerboard Price		\$1,580	\$2,105	\$2,545	\$3,181
Fabric/Vinyl Base Price		\$2,230	\$2,415	\$3,050	\$3,813
Fabric/Vinyl Grade 1	FG1/VG1	+ \$0	+ \$0	+ \$0	+ \$0
Fabric/Vinyl Grade 2	FG2/VG2	+ \$85	+ \$170	+ \$170	+ \$210
Fabric/Vinyl Grade 3	FG3/VG3	+ \$225	+ \$450	+ \$450	+ \$560
Fabric/Vinyl Grade 4	FG4/VG4	+ \$395	+ \$790	+ \$790	+ \$980
Fabric/Vinyl Grade 5	FG5/VG5	+ \$680	+ \$1,360	+ \$1,360	+ \$5,493
60" Wide Screens, Two-Seat Back-to-Back		18" x 60"	24" x 60"	30" x 60"	36" x 60"
Markerboard Price		\$393	\$525	\$635	\$794
Fabric/Vinyl Base Price		\$502	\$593	\$717	\$896
Fabric/Vinyl Grade 1	FG1/VG1	+ \$0	+ \$0	+ \$0	+ \$0
Fabric/Vinyl Grade 2	FG2/VG2	+ \$21	+ \$42	+ \$50	+ \$50
Fabric/Vinyl Grade 3	FG3/VG3	+ \$56	+ \$112	+ \$133	+ \$133
Fabric/Vinyl Grade 4	FG4/VG4	+ \$98	+ \$196	+ \$233	+ \$233
Fabric/Vinyl Grade 5	FG5/VG5	+ \$168	+ \$336	+ \$400	+ \$400

EFFECTIVE OCTOBER 17, 2022

4. Material (Cont.)

Material Grade	Code	18" (H) Price	24" (H) Price	30" (H) Price	36" (H) Price
60" Wide Screens, Four-Seat Back-to-Back		18" x 60"	24" x 60"	30" x 60"	36" x 60"
Markerboard Price		\$786	\$1,050	\$1,270	\$1,588
Fabric/Vinyl Base Price		\$1,004	\$1,186	\$1,434	\$1,793
Fabric/Vinyl Grade 1	FG1/VG1	+ \$0	+ \$0	+ \$0	+ \$0
Fabric/Vinyl Grade 2	FG2/VG2	+ \$42	+ \$84	+ \$100	+ \$100
Fabric/Vinyl Grade 3	FG3/VG3	+ \$112	+ \$224	+ \$266	+ \$266
Fabric/Vinyl Grade 4	FG4/VG4	+ \$196	+ \$392	+ \$466	+ \$466
Fabric/Vinyl Grade 5	FG5/VG5	+ \$336	+ \$672	+ \$800	+ \$800
60" Wide Screens, Six-Seat Back-to-Back		18" x 60"	24" x 60"	30" x 60"	36" x 60"
Markerboard Price		\$1,179	\$1,575	\$1,905	\$2,381
Fabric/Vinyl Base Price		\$1,506	\$1,779	\$2,151	\$2,689
Fabric/Vinyl Grade 1	FG1/VG1	+ \$0	+ \$0	+ \$0	+ \$0
Fabric/Vinyl Grade 2	FG2/VG2	+ \$63	+ \$126	+ \$150	+ \$150
Fabric/Vinyl Grade 3	FG3/VG3	+ \$168	+ \$336	+ \$399	+ \$399
Fabric/Vinyl Grade 4	FG4/VG4	+ \$294	+ \$588	+ \$699	+ \$699
Fabric/Vinyl Grade 5	FG5/VG5	+ \$504	+ \$1,008	+ \$1,200	+ \$1,200
60" Wide Screens, Eight-Seat Back-to-Back		18" x 60"	24" x 60"	30" x 60"	36" x 60"
Markerboard Price		\$1,572	\$2,100	\$2,540	\$3,175
Fabric/Vinyl Base Price		\$2,008	\$2,372	\$2,868	\$3,585
Fabric/Vinyl Grade 1	FG1/VG1	+ \$0	+ \$0	+ \$0	+ \$0
Fabric/Vinyl Grade 2	FG2/VG2	+ \$84	+ \$168	+ \$200	+ \$200
Fabric/Vinyl Grade 3	FG3/VG3	+ \$224	+ \$448	+ \$532	+ \$532
Fabric/Vinyl Grade 4	FG4/VG4	+ \$392	+ \$784	+ \$932	+ \$932
Fabric/Vinyl Grade 5	FG5/VG5	+ \$672	+ \$1,344	+ \$1,600	+ \$1,600
60" Wide Screens, Ten-Seat Back-to-Back		18" x 60"	24" x 60"	30" x 60"	36" x 60"
Markerboard Price		\$1,965	\$2,625	\$3,175	\$3,969
Fabric/Vinyl Base Price		\$2,510	\$2,965	\$3,585	\$4,481
Fabric/Vinyl Grade 1	FG1/VG1	+ \$0	+ \$0	+ \$0	+ \$0
Fabric/Vinyl Grade 2	FG2/VG2	+ \$105	+ \$210	+ \$250	+ \$250
Fabric/Vinyl Grade 3	FG3/VG3	+ \$280	+ \$560	+ \$665	\$665
Fabric/Vinyl Grade 4	FG4/VG4	+ \$490	+ \$980	+ \$1,165	+ \$1,165
Fabric/Vinyl Grade 5	FG5/VG5	+ \$840	+ \$1,680	+ \$2,000	+ \$2,000
72" Wide Screens, Two-Seat Back-to-Back		18" x 72"	24" x 72"	30" x 72"	36" x 72"
Markerboard Price		\$475	\$629	\$761	\$951
Fabric/Vinyl Base Price		\$565	\$731	\$757	\$946
Fabric/Vinyl Grade 1	FG1/VG1	+ \$0	+ \$0	+ \$0	+ \$0
Fabric/Vinyl Grade 2	FG2/VG2	+ \$25	+ \$50	+ \$50	+ \$50
Fabric/Vinyl Grade 3	FG3/VG3	+ \$66	+ \$133	+ \$133	+ \$133
Fabric/Vinyl Grade 4	FG4/VG4	+ \$116	+ \$233	+ \$233	+ \$233
Fabric/Vinyl Grade 5	FG5/VG5	+ \$200	+ \$400	+ \$400	+ \$400

EFFECTIVE OCTOBER 17, 2022

4. Material (Cont.)

Material Grade	Code	18" (H) Price	24" (H) Price	30" (H) Price	36" (H) Price
72" Wide Screens, Four-Seat Back-to-Back		18" x 72"	24" x 72"	30" x 72"	36" x 72"
Markerboard Price		\$950	\$1,258	\$1,522	\$1,903
Fabric/Vinyl Base Price		\$1,130	\$1,462	\$1,514	\$1,893
Fabric/Vinyl Grade 1	FG1/VG1	+ \$0	+ \$0	+ \$0	+ \$0
Fabric/Vinyl Grade 2	FG2/VG2	+ \$50	+ \$100	+ \$100	+ \$100
Fabric/Vinyl Grade 3	FG3/VG3	+ \$132	+ \$266	+ \$266	+ \$266
Fabric/Vinyl Grade 4	FG4/VG4	+ \$232	+ \$466	+ \$466	+ \$466
Fabric/Vinyl Grade 5	FG5/VG5	+ \$400	+ \$800	+ \$800	+ \$800
72" Wide Screens, Six-Seat Back-to-Back		18" x 72"	24" x 72"	30" x 72"	36" x 72"
Markerboard Price		\$1,425	\$1,887	\$2,283	\$2,854
Fabric/Vinyl Base Price		\$1,695	\$2,193	\$2,271	\$2,839
Fabric/Vinyl Grade 1	FG1/VG1	+ \$0	+ \$0	+ \$0	+ \$0
Fabric/Vinyl Grade 2	FG2/VG2	+ \$75	+ \$150	+ \$150	+ \$150
Fabric/Vinyl Grade 3	FG3/VG3	+ \$198	+ \$399	+ \$399	+ \$399
Fabric/Vinyl Grade 4	FG4/VG4	+ \$348	+ \$699	+ \$699	+ \$699
Fabric/Vinyl Grade 5	FG5/VG5	+ \$600	+ \$1,200	+ \$1,200	+ \$1,200
72" Wide Screens, Eight-Seat Back-to-Back		18" x 72"	24" x 72"	30" x 72"	36" x 72"
Markerboard Price		\$1,900	\$2,516	\$3,044	\$3,805
Fabric/Vinyl Base Price		\$2,260	\$2,924	\$3,028	\$3,785
Fabric/Vinyl Grade 1	FG1/VG1	+ \$0	+ \$0	+ \$0	+ \$0
Fabric/Vinyl Grade 2	FG2/VG2	+ \$100	+ \$200	+ \$200	+ \$200
Fabric/Vinyl Grade 3	FG3/VG3	+ \$264	+ \$532	+ \$532	+ \$532
Fabric/Vinyl Grade 4	FG4/VG4	+ \$464	+ \$932	+ \$932	+ \$932
Fabric/Vinyl Grade 5	FG5/VG5	+ \$800	+ \$1,600	+ \$1,600	+ \$1,600
72" Wide Screens, Ten-Seat Back-to-Back		18" x 72"	24" x 72"	30" x 72"	36" x 72"
Markerboard Price		\$2,375	\$3,145	\$3,805	\$4,756
Fabric/Vinyl Base Price		\$2,825	\$3,655	\$3,785	\$4,731
Fabric/Vinyl Grade 1	FG1/VG1	+ \$0	+ \$0	+ \$0	+ \$0
Fabric/Vinyl Grade 2	FG2/VG2	+ \$125	+ \$250	+ \$250	+ \$250
Fabric/Vinyl Grade 3	FG3/VG3	+ \$330	+ \$665	+ \$665	+ \$665
Fabric/Vinyl Grade 4	FG4/VG4	+ \$580	+ \$1,165	+ \$1,165	+ \$1,165
Fabric/Vinyl Grade 5	FG5/VG5	+ \$1,000	+ \$2,000	+ \$2,000	+ \$2,000

Please reference the [Textile Reference Guide](#) for information on approved textiles for Motif products.

1. Product

Product Category	Code	Price	
Stand-Alone HiQ Accessory	3299	Priced by Size	
Product Type	Code	Price	
Boundary Screen	ATC10	Priced by Size	

2. Size

Screen Size (H x W)	Code	Price	
For Benches Without Center Screens			
29" x 51"	BS2951	\$529	
29" x 63"	BS2963	\$615	
For Benches With 18" Center Screens			
42" x 51"	BS4251	\$675	
42" x 63"	BS4263	\$750	
For Benches With 24" Center Screens			
48" x 51"	BS4851	\$703	
48" x 63"	BS4863	\$825	
For Benches With 30" Center Screens			
54" x 51"	BS5451	\$827	
54" x 63"	BS5463	\$1,021	
For Benches With 36" Center Screens			
60" x 51"	BS6051	\$918	
60" x 63"	BS6063	\$1,134	

Price is for a single boundary screen, not a pair.

BOUNDARY SCREENS**3. Material**

Screen Material Type	Code	Price	
Laminate	DT501	+ \$0	
Laminate Grade	Code	Price	
Grade 1	GR1	+ \$0	
Laminate Finish	Code	Price	
Ankara Cherry	TL18	+ \$0	
Black	TL19	+ \$0	
Brazilian Walnut	TL20	+ \$0	
Cabinet Maple	TL21	+ \$0	
Driftwood	TL23	+ \$0	
Folkstone Grey	TL24	+ \$0	
Libretti	TL25	+ \$0	
Queenston Oak	TL26	+ \$0	
Sandlewood	TL27	+ \$0	
Walnut Amati	TL28	+ \$0	
White	TL29	+ \$0	

4. Finish

Paint Color for Brackets	Code	Price	
Silver	BF01	+ \$0	
White	BF02	+ \$0	
Black	BF03	+ \$0	

Cable Trough

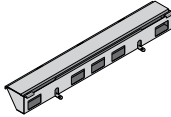
Product Category	Code	Price	Price
Stand-Alone HiQ Accessory	3299	Priced By Product Type	
Product Type	Code	Price	
Single Cable Trough	ATC09 CT01	\$150	
Tabletop Width	Code	Price	
46"	TRL46	+ \$0	
58"	TRL58	+ \$0	
70"	TRL70	+ \$0	
Product Color	Code		Price
Silver	BF01	+ \$0	
White	BF02	+ \$0	
Black	BF03	+ \$0	

Vertical Cable Carrier

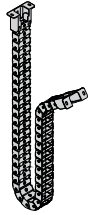
Product Category	Code	Price	
Stand-Alone HiQ Accessory	3299	Priced By Product Type	
Product Type	Code	Price	
Vertical Wire Manager	ATC01 VC01	\$105	
Product Color	Code	Price	
Black	VCC03	+ \$0	

STAND-ALONE ACCESSORIES: POWER AND CABLE MANAGEMENT

Duplex Receptacle

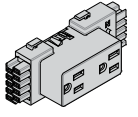
Product Category	Code	Price	
Stand-Alone HiQ Accessory	3299	Priced By Product Type	
Product Type	Code	Price	
Duplex Receptacle	ATC04	\$40	
Circuits	Code	Price	
Circuit 1 (3+1, 2+2)	DC1	+ \$0	
Circuit 2 (3+1, 2+2)	DC2	+ \$0	
Circuit 3 (3+1)	DC3	+ \$0	
Circuit 3 (2+2)	DC3D	+ \$0	
Circuit 4 (3+1, 2+2)	DC4	+ \$0	
Controlled			
Circuit 1 (3+1, 2+2)	DC1C	+ \$7	
Circuit 2 (3+1, 2+2)	DC2C	+ \$7	
Circuit 3 (3+1)	DC3C	+ \$7	
Circuit 3 (2+2)	DC3CD	+ \$7	
Circuit 4 (3+1, 2+2)	DC4C	+ \$7	

Power Infeed

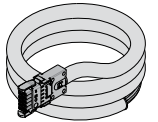
Product Category	Code	Price	
Stand-Alone HiQ Accessory	3299	Priced By Product Type	
Product Type	Code	Price	
Power Infeed	ATC05	Priced by Conduit Style	
Conduit Style	Code	Price	
72" Conduit	PIC72	\$147	
72" Liquidtight	PIL72	\$159	
144" Conduit	PIC144	\$194	
144" Liquidtight	PIL144	\$206	

Power Jumper

Product Category	Code	Price	
Stand-Alone HiQ Accessory	3299	Priced By Product Type	
Product Type	Code	Price	
Power Jumper	ATC12	Priced by Conduit Style	

Prise

BENCHING TYPICALS

One size really does fit all. Prise is the go-to solution for modular benching, allowing you to build and arrange to fit your workspace. Keep cords, electronics and more all together with standard integrated power trays and slide-out tabletops.



Private Office



Conference



Side-by-Side



Three-Seat



Three-Seat With Screens



Three-Seat With Returns



Six-Seat With Screens



Six-Seat With Returns

EFFECTIVE OCTOBER 17, 2022

1. Side-by-Side Typical

Category	Code	Quantity	Description	List Price	Ext. Price
Bench Top	3021 SS SP2 TZ2472 TL27 GP05 GC02	1	Set of Two Bench Tops: 24" x 72", Grade 1 Laminate, Left and Right Grommets	\$898	\$898
Bench Base	3022 SS SP2 TZ2472 PIW	1	2-Seat Base: Single-Sided, 8-Wire Wall Infeed (Pairs With 24" x 72" Bench Top)	\$2,761	\$2,761
Modesty Screen	3093 MT8 DT501 MPC27 DS1066	2	Modesty Screen: 10" x 66", Grade 1 Laminate	\$338	\$676
Wire Management	3152 WM05	2	Cable Caddy Basket Without Power	\$98	\$196
TOTAL:					\$4,531

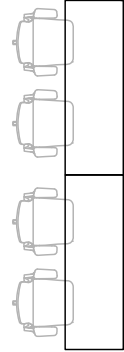

2. Private Office Typical

Category	Code	Quantity	Description	List Price	Ext. Price
Bench Top	3021 SS SP1 TZ3072 TL27 GP00	1	Bench Top: 30" x 72", Grade 1 Laminate, No Grommets	\$484	\$484
Tabletop	3000 TZ2448 TL27 GP00 TTMP1 STF00	1	Rectangular Tabletop: 24" x 48", Grade 1 Laminate, Mending Plate Kit, No Stiffener, No Grommets	\$335	\$335
Tabletop	3000 TZ2472 TL27 GP00 TTMP1 STF00	1	Rectangular Tabletop: 24" x 72", Grade 1 Laminate, Mending Plate Kit, No Stiffener, No Grommets	\$463	\$463
Bench Base	3022 SS SP1 TZ3072 NPOW	1	1-Seat Base: Single-Sided, No Power (Pairs With 30" x 72" Bench Top)	\$1,029	\$1,029
Bench Base	3022 SS SP1 TZ2472 NPOW	1	1-Seat Base: Single-Sided, No Power (Pairs With 24" x 72" Tabletop)	\$1,029	\$1,029
Modesty Screen	3093 MT8 DT501 MPC27 DS1066	1	Modesty Screen: 10" x 66", Grade 1 Laminate	\$338	\$338
Storage	3150 CPT01 PDC02	1	Mobile Pedestal With Upholstered Cushion, Grade 1 Textile	\$508	\$508
TOTAL:					\$4,186

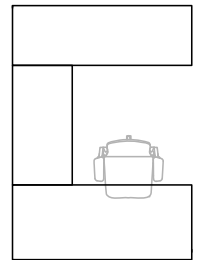

See page 109 to order table tops.

EFFECTIVE OCTOBER 17, 2022

3. Conference Typical

Category	Code	Quantity	Description	List Price	Ext. Price
Tabletop	3000 TZ4896 TL27 GP00 TTMP0 STF00	1	Rectangular Tabletop: 48" x 96", Grade 1 Laminate, No Grommets, No Stiffener	\$1,152	\$1,152
Bench Base	3022 BB SP2 TZ3066 NPOW	1	2-Seat Base: Back-to-Back, No Power	\$1,617	\$1,617

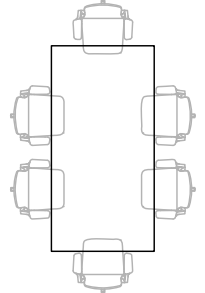

See page 109 to order oversized tabletops.

TOTAL: \$2,769

4. Three Seat Typical

Category	Code	Quantity	Description	List Price	Ext. Price
Bench Top	3021 SS SP3 TZ3060 TL27 GP05 GC02	1	Set of Three Bench Tops: 30" x 60", Grade 1 Laminate, Left and Right Grommets	\$1,392	\$1,392
Bench Base	3022 SS SP3 TZ3060 PIW	1	3-Seat Base: Single-Sided, 8-Wire Wall Infeed (Pairs With 30" x 60" Bench Top)	\$4,018	\$4,018
Modesty Screen	3093 MT8 DT501 MPC27 DS1054	3	Modesty Screen: 10" x 54", Grade 1 Laminate	\$289	\$867
Storage	3150 CPT01 PDC02	3	Mobile Pedestal With Upholstered Cushion, Grade 1 Textile	\$508	\$1,524
Wire Management	3152 WM05	3	Cable Caddy Basket Without Power	\$98	\$294

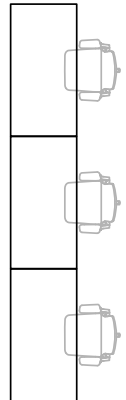

TOTAL: \$8,095

5. Three Seat Typical With Screens

Category	Code	Quantity	Description	List Price	Ext. Price
Bench Top	3021 SS SP3 TZ3060 TL27 GP05 GC02	1	Set of Three Bench Tops: 30" x 60", Grade 1 Laminate, Left and Right Grommets	\$1,392	\$1,392
Bench Base	3022 SS SP3 TZ3060 PIW	1	3-Seat Base: Single Sided, 8-Wire Wall Infeed (Pairs With 30" x 60" Bench Top)	\$4,018	\$4,018
Screen	3090 MT5 DT701 DS3060	3	30" x 60" Screen, Fabric, Grade 1 Textile, Midway Mounts	\$793	\$2,379
Storage	3150 CPT01 PDC02	3	Mobile Pedestal With Upholstered Cushion, Grade 1 Textile	\$508	\$1,524
Wire Management	3152 WM05	3	Cable Caddy Basket Without Power	\$98	\$294

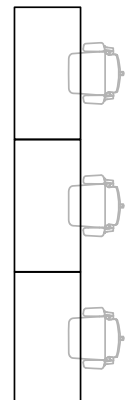

See the screens section starting page page 525 for midway mounts and other screen options

TOTAL: \$9,607

EFFECTIVE OCTOBER 17, 2022

6. Three-Seat Typical With Returns

Category	Code	Quantity	Description	List Price	Ext. Price
Bench Top	3021 SS SP3 TZ3072 TL27 GP05 GC02	1	Set of Three Bench Tops: 30" x 72", Grade 1 Laminate, Left and Right Grommets	\$1,632	\$1,632
Return Top	3024 SS SP3 RP3 TN2448 TL27 GPR00	1	Set of Three Returntops: 24" x 48", Grade 1 Laminate, No Grommets	\$783	\$783
Bench Base	3022 SS SP3 TZ3072 PIW	1	3-Seat Base: Single-Sided, 8-Wire Wall Infeed (Pairs With 30" x 72" Bench Tops)	\$4,018	\$4,018
Return Base	3025 SS SP3 RP3 TN2448	1	Set of Three Return Bases: Single-Sided (Pairs With 24" x 48" Returntops)	\$1,680	\$1,680
Modesty Screen	3093 MT8 DT501 MPC27 DS1066	3	Modesty Screen: 10" x 66", Laminate	\$338	\$1,014
Storage	3150 CPT01 PDC02	3	Mobile Pedestal With Upholstered Cushion, Grade 1 Textile	\$508	\$1,524
Wire Management	3152 WM05	3	Cable Caddy Basket Without Power	\$98	\$294

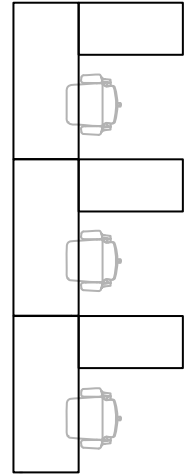

TOTAL: \$10,945

7. Six-Seat Typical With Screens

Category	Code	Quantity	Description	List Price	Ext. Price
Bench Top	3021 BB SP6 TZ3060 TL27 GP05 GC02	1	Set of Six Bench Tops: 30" x 60", Grade 1 Laminate, Left and Right Grommets	\$2,784	\$2,784
Bench Base	3022 BB SP6 TZ3060 PIW	1	6-Seat Base: Back-to-Back, 8-Wire Wall Infeed (Pairs With 30" x 60" Bench Tops)	\$6,068	\$6,068
Screen	3023 BB SP6 TZ3060 DT701 DS1860	1	Set of Three Screens: 18" x 60", Prise Mounts, Fabric, Grade 1 Textile	\$1,506	\$1,506
Storage	3150 CPT01 PDC02	6	Mobile Pedestal With Upholstered Cushion, Grade 1 Textile	\$508	\$3,048

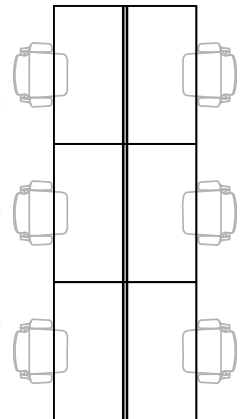

TOTAL: \$13,406

EFFECTIVE OCTOBER 17, 2022

8. Six-Seat Typical With Returns

Category	Code	Quantity	Description	List Price	Ext. Price	
Bench Top	3021 BB SP6 TZ3072 TL27 GP05 GC02	1	Set of Six Bench Tops: 30" x 72", Grade 1 Laminate, Left and Right Grommets	\$3,264	\$3,264	
Return Top	3024 BB SP6 RP6 TN2448 TL27 GPR00	1	Set of Six Returntops: 24" x 48", Grade 1 Laminate, No Grommets	\$1,566	\$1,566	
Bench Base	3022 BB SP6 TZ3072 PIW	1	6-Seat Base: Back-to-Back, 8-Wire Wall Infeed (Pairs With 30" x 72" Bench Tops)	\$6,068	\$6,068	
Return Base	3025 BB SP6 RP6 TN2448	1	Set of Six Return Bases (Pairs With 24" x 48" Returntops)	\$3,360	\$3,360	
Screen	3023 BB SP6 TZ3072 DT701 DS1872	1	Set of Three Screens: 18" x 72", Prise Mounts, Fabric, Grade 1 Textile	\$1,695	\$1,695	
Storage	3150 CPT01 PDC02	6	Mobile Pedestal With Upholstered Cushion, Grade 1 Textile	\$508	\$3,048	

TOTAL: \$19,001

Prise

BENCHING

One size really does fit all. Prise is the go-to solution for modular benching, allowing you to build and arrange to fit your workspace. Keep cords, electronics and more all together with standard integrated power trays and slide-out tabletops.



6-Seat

Chairs not included; see [page 127](#) for Novo.
Storage not included; see [page 576](#) for mobile pedestals.

EFFECTIVE OCTOBER 17, 2022

Featured Models

2-SEAT :: \$4,531

2-seat, single-sided,
24" x 72" bench tops, 10" x 66"
laminated modesty screens, and wire
basket wire management

6-SEAT :: \$13,406

6-seat, back-to-back, 30" x 60" bench
tops with grommets on the left and
right, 18" x 60" fabric screens, mobile
pedestals with upholstered pads

6-SEAT+RETURNS :: \$19,001

6-seat, back-to-back, 30" x 72"
bench tops with grommets on the left
and right, 18" x 72" fabric screens,
24" x 48" returns, mobile pedestals
with upholstered pads

Features

- Steel-frame-constructed bench with standard white base
- Mount screens easily with centered built-in extrusion on bench
- Manage wires with standard integrated power trays and slide-out function for tabletops
- Choose from 11 standard laminate tabletop finishes
- Pick grommets from two colors and specify in multiple locations
- Fixed glides are standard on all models
- Four power ports come standard per bench station; data add-on optional when specified with power
- Provide added convenience with a variety of additional wire management and power options





SPECIFICATIONS

	3021 SS Single-Sided Benching	3021 BB Back-to-Back Benching
Total Depth of Benches	24" 30"	51.44" (24" Top) 63.44" (30" Top)
Space Between Back-to-Back Benches	N/A	3.44"
Gap on Either Side of Center Rail	N/A	1.09"
Bench Top Thickness	1.125"	1.125"
Side-to-Side Gap (Mid Run)	0.125"	0.125"
Height With Bench Top	29.3"	29.3"
Height From Floor to Underside of Base	24.24"	24.24"
Distance Between Legs (Depth) at Base (Inside-Edge-to-Inside-Edge End)	17.52"	40.42"
Distance Between Legs (Depth) at Top	9"	32"
Distance Between Legs at Base (Outside-Edge-to-Outside-Edge)	23.96"	46.85"
Leg Depth	3.17"	3.17"
Leg Width	1.99"	1.99"
Weight Capacity (Per Seat or Return)	200 lb	200 lb

BENCH TOP

TOPS AND BASES ARE SPECIFIED AND SOLD SEPARATELY.

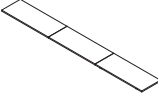
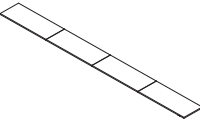
1. Product

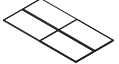
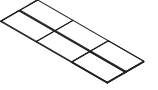
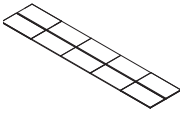
Product Type	Code	Price	
Bench Top	3021	Priced by Size	
Orientation	Code	Price	
Single-Sided	SS	Priced by Size	
Back-to-Back	BB	Priced by Size	
Seated Positions	Code	Price	
Single-Sided			
One Seat	SP1	Priced by Size	
Two Seats	SP2	Priced by Size	
Three Seats	SP3	Priced by Size	
Four Seats	SP4	Priced by Size	
Back-to-Back			
Two Seats	SP2	Priced by Size	
Four Seats	SP4	Priced by Size	
Six Seats	SP6	Priced by Size	
Eight Seats	SP8	Priced by Size	
Matching Base Style	Code	Price	
2-Stage T-Leg	TBT5	Priced by Size	

2. Finish

Laminate	Code	Price
Grade 1 Laminate		
Ankara Cherry	TL18	Priced by Size
Black	TL19	Priced by Size
Brazilian Walnut	TL20	Priced by Size
Cabinet Maple	TL21	Priced by Size
Driftwood	TL23	Priced by Size
Folkstone Grey	TL24	Priced by Size
Libretti	TL25	Priced by Size
Queenston Oak	TL26	Priced by Size
Sandalwood	TL27	Priced by Size
Walnut Amati	TL28	Priced by Size
White	TL29	Priced by Size
Grade 2 Laminate		
Classic Linen	TL17	Priced by Size
Colombian Walnut	TL55	Priced by Size
Crisp Linen	TL64	Priced by Size
Designer White	TL66	Priced by Size
Field Elm	TL13	Priced by Size
Frosty White	TL16	Priced by Size
Grey	TL62	Priced by Size
Grey Elm	TL51	Priced by Size
Kingswood Walnut	TL53	Priced by Size
Manitoba	TL56	Priced by Size
Neo Walnut	TL50	Priced by Size
Platinum	TL61	Priced by Size
Portico Teak	TL60	Priced by Size
Skyline Walnut	TL15	Priced by Size
Steel Mesh	TL59	Priced by Size
Tuscan Walnut	TL57	Priced by Size
Uptown Walnut	TL14	Priced by Size
Laminate Grade	Code	Price
Laminate Grade 1	GR1	Priced by Size
Laminate Grade 2	GR2	Priced by Size

BENCH TOP

TOPS AND BASES ARE SPECIFIED AND SOLD SEPARATELY.

3. Shape

Bench Top Shape	Code	Price
Rectangular Bench Top	TZ	Priced by Size

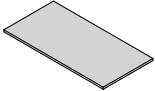

4. Size

Depth x Width	Code	Laminate Price	
One Seat (SS)		Grade 1	Grade 2
24" x 48"	2448	\$261	\$392
24" x 54"	2454	\$292	\$438
24" x 60"	2460	\$324	\$486
24" x 66"	2466	\$358	\$537
24" x 72"	2472	\$389	\$584
30" x 48"	3048	\$324	\$486
30" x 54"	3054	\$366	\$549
30" x 60"	3060	\$404	\$606
30" x 66"	3066	\$445	\$668
30" x 72"	3072	\$484	\$726
Two Seats (SS or BB)		Grade 1	Grade 2
24" x 48"	2448	\$522	\$784
24" x 54"	2454	\$584	\$876
24" x 60"	2460	\$648	\$972
24" x 66"	2466	\$716	\$1,074
24" x 72"	2472	\$778	\$1,168
30" x 48"	3048	\$648	\$972
30" x 54"	3054	\$732	\$1,098
30" x 60"	3060	\$808	\$1,212
30" x 66"	3066	\$890	\$1,336
30" x 72"	3072	\$968	\$1,452
Three Seats (SS)		Grade 1	Grade 2
24" x 48"	2448	\$783	\$1,176
24" x 54"	2454	\$876	\$1,314
24" x 60"	2460	\$972	\$1,458
24" x 66"	2466	\$1,074	\$1,611
24" x 72"	2472	\$1,167	\$1,752
30" x 48"	3048	\$972	\$1,458
30" x 54"	3054	\$1,098	\$1,647
30" x 60"	3060	\$1,212	\$1,818
30" x 66"	3066	\$1,335	\$2,004
30" x 72"	3072	\$1,452	\$2,178

4. Size (Cont.)

Depth x Width	Code	Laminate Price	
		Grade 1	Grade 2
Four Seats (SS or BB)			
24" x 48"	2448	\$1,044	\$1,568
24" x 54"	2454	\$1,168	\$1,752
24" x 60"	2460	\$1,296	\$1,944
24" x 66"	2466	\$1,432	\$2,148
24" x 72"	2472	\$1,556	\$2,336
30" x 48"	3048	\$1,296	\$1,944
30" x 54"	3054	\$1,464	\$2,196
30" x 60"	3060	\$1,616	\$2,424
30" x 66"	3066	\$1,780	\$2,672
30" x 72"	3072	\$1,936	\$2,904
Six Seats (BB)			
24" x 48"	2448	\$1,566	\$2,352
24" x 54"	2454	\$1,752	\$2,628
24" x 60"	2460	\$1,944	\$2,916
24" x 66"	2466	\$2,148	\$3,222
24" x 72"	2472	\$2,334	\$3,504
30" x 48"	3048	\$1,944	\$2,916
30" x 54"	3054	\$2,196	\$3,294
30" x 60"	3060	\$2,424	\$3,636
30" x 66"	3066	\$2,670	\$4,008
30" x 72"	3072	\$2,904	\$4,356
Eight Seats (BB)			
24" x 48"	2448	\$2,088	\$3,136
24" x 54"	2454	\$2,336	\$3,504
24" x 60"	2460	\$2,592	\$3,888
24" x 66"	2466	\$2,864	\$4,296
24" x 72"	2472	\$3,112	\$4,672
30" x 48"	3048	\$2,592	\$3,888
30" x 54"	3054	\$2,928	\$4,392
30" x 60"	3060	\$3,232	\$4,848
30" x 66"	3066	\$3,560	\$5,344
30" x 72"	3072	\$3,872	\$5,808







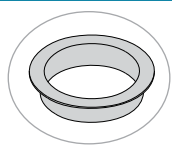

BENCH TOP

TOPS AND BASES ARE SPECIFIED AND SOLD SEPARATELY.

5. Grommets

Grommet Location	Code	Price	
None	GP00	+ \$0	
One Seat (SS)			
Left	GP01	+ \$30	
Right	GP03	+ \$30	
Left and Right	GP05	+ \$60	
Two Seats (SS or BB)			
Left	GP01	+ \$60	
Right	GP03	+ \$60	
Left and Right	GP05	+ \$120	
Three Seats (SS)			
Left	GP01	+ \$90	
Right	GP03	+ \$90	
Left and Right	GP05	+ \$180	
Four Seats (SS or BB)			
Left	GP01	+ \$120	
Right	GP03	+ \$120	
Left and Right	GP05	+ \$240	
Six Seats (BB)			
Left	GP01	+ \$180	
Right	GP03	+ \$180	
Left and Right	GP05	+ \$360	
Eight Seats (BB)			
Left	GP01	+ \$240	
Right	GP03	+ \$240	
Left and Right	GP05	+ \$480	
Grommet Color	Code	Price	
Black	GC01	+ \$0	
White	GC02	+ \$0	

1. Product

Product Type	Code	Price	
Bench Bases	3022	Priced by Seated Positions	
Product Style	Code	Price	
2-Stage T-Leg	TBT5	Priced by Seated Positions	
Orientation	Code	Price	
Single-Sided	SS	Priced by Seated Positions	
Back-to-Back	BB	Priced by Seated Positions	
Seated Postions	Code	Price	
Single-Sided			
1-Seat	SP1	\$1,029	
2-Seat	SP2	\$1,830	
3-Seat	SP3	\$2,631	
4- Seat	SP4	\$3,431	
Back-to-Back			
2-Seat	SP2	\$1,617	
4-Seat	SP4	\$2,773	
6-Seat	SP6	\$3,930	
8-Seat	SP8	\$5,086	

BENCH BASE

TOPS AND BASES ARE SPECIFIED AND SOLD SEPARATELY.

2. Matching Tabletop

Tabletop Shape	Code	Price	
Rectangular	TZ	+ \$0	
Tabletop Size			
No Top	0	+ \$0	
24" x 48"	2448	+ \$0	
24" x 54"	2454	+ \$0	
24" x 60"	2460	+ \$0	
24" x 66"	2466	+ \$0	
24" x 72"	2472	+ \$0	
30" x 48"	3048	+ \$0	
30" x 54"	3054	+ \$0	
30" x 60"	3060	+ \$0	
30" x 66"	3066	+ \$0	
30" x 72"	3072	+ \$0	

Bench bases require the specification of a bench top size. Bases take their size from their corresponding top size.

3. Power

Power Type	Code	Price	
No Power Pack	NPOW	+ \$0	
Single-Sided, 8-Wire Wall Infeed			
One Seat	PIW	+ \$477	
Two Seats	PIW	+ \$931	
Three Seats	PIW	+ \$1,387	
Four Seats	PIW	+ \$1,844	
Single-Sided, 8-Wire Ceiling Infeed			
One Seat	PIC	+ \$506	
Two Seats	PIC	+ \$962	
Three Seats	PIC	+ \$1,421	
Four Seats	PIC	+ \$1,876	
Back-to-Back, 8-Wire Wall Infeed			
Two Seats	PIW	+ \$725	
Four Seats	PIW	+ \$1,431	
Six Seats	PIW	+ \$2,138	
Eight Seats	PIW	+ \$2,845	
Back-to-Back, 8-Wire Ceiling Infeed			
Two Seats	PIC	+ \$759	
Four Seats	PIC	+ \$1,464	
Six Seats	PIC	+ \$2,170	
Eight Seats	PIC	+ \$2,878	

Infeeds come standard with one dual outlet power module per seat.

EFFECTIVE OCTOBER 17, 2022

1. Return Top

Product Type	Code	Price
Return Top	3024	Priced by Size
Orientation	Code	Price
Single-Sided	SS	Priced by Size
Back-to-Back	BB	Priced by Size
Seated Postions	Code	Price
Single-Sided		
One Seat	SP1	Priced by Size
Two Seats	SP2	Priced by Size
Three Seats	SP3	Priced by Size
Four Seats	SP4	Priced by Size
Back-to-Back		
Two Seats	SP2	Priced by Size
Four Seats	SP4	Priced by Size
Six Seats	SP6	Priced by Size
Eight Seats	SP8	Priced by Size
Return Quantity	Code	Price
One	RP1	Priced by Size
Two	RP2	Priced by Size
Three	RP3	Priced by Size
Four	RP4	Priced by Size
Five	RP5	Priced by Size
Six	RP6	Priced by Size
Seven	RP7	Priced by Size
Eight	RP8	Priced by Size

RETURN TOP

TOPS AND BASES ARE SPECIFIED AND SOLD SEPARATELY.

2. Finish

Laminate	Code	Price
Grade 1 Laminate		
Ankara Cherry	TL18	Priced by Size
Black	TL19	Priced by Size
Brazilian Walnut	TL20	Priced by Size
Cabinet Maple	TL21	Priced by Size
Driftwood	TL23	Priced by Size
Folkstone Grey	TL24	Priced by Size
Libretti	TL25	Priced by Size
Queenston Oak	TL26	Priced by Size
Sandalwood	TL27	Priced by Size
Walnut Amati	TL28	Priced by Size
White	TL29	Priced by Size
Grade 2 Laminate		
Classic Linen	TL17	Priced by Size
Colombian Walnut	TL55	Priced by Size
Crisp Linen	TL64	Priced by Size
Designer White	TL66	Priced by Size
Field Elm	TL13	Priced by Size
Frosty White	TL16	Priced by Size
Grey	TL62	Priced by Size
Grey Elm	TL51	Priced by Size
Kingswood Walnut	TL53	Priced by Size
Manitoba	TL56	Priced by Size
Neo Walnut	TL50	Priced by Size
Platinum	TL61	Priced by Size
Portico Teak	TL60	Priced by Size
Skyline Walnut	TL15	Priced by Size
Steel Mesh	TL59	Priced by Size
Tuscan Walnut	TL57	Priced by Size
Uptown Walnut	TL14	Priced by Size
Laminate Grade	Code	Price
Laminate Grade 1	GR1	Priced by Size
Laminate Grade 2	GR2	Priced by Size

3. Shape

Bench Top Shape	Code	Price
Rectangular Return Top	TN	Priced by Size

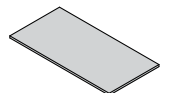

4. Size

Returntop Size (D x W)	Code	Price	
One		Grade 1	Grade 2
24" x 36"	2436	\$196	\$294
24" x 42"	2442	\$229	\$344
24" x 48"	2448	\$261	\$392
30" x 30"	3030	\$205	\$308
30" x 36"	3036	\$244	\$366
30" x 42"	3042	\$285	\$428
Two		Grade 1	Grade 2
24" x 36"	2436	\$392	\$588
24" x 42"	2442	\$458	\$688
24" x 48"	2448	\$522	\$784
30" x 30"	3030	\$410	\$616
30" x 36"	3036	\$488	\$732
30" x 42"	3042	\$570	\$856
Three		Grade 1	Grade 2
24" x 36"	2436	\$588	\$882
24" x 42"	2442	\$687	\$1,032
24" x 48"	2448	\$783	\$1,176
30" x 30"	3030	\$615	\$924
30" x 36"	3036	\$732	\$1,098
30" x 42"	3042	\$855	\$1,284
Four		Grade 1	Grade 2
24" x 36"	2436	\$784	\$1,176
24" x 42"	2442	\$916	\$1,376
24" x 48"	2448	\$1,044	\$1,568
30" x 30"	3030	\$820	\$1,232
30" x 36"	3036	\$976	\$1,464
30" x 42"	3042	\$1,140	\$1,712
Five		Grade 1	Grade 2
24" x 36"	2436	\$980	\$1,470
24" x 42"	2442	\$1,145	\$1,720
24" x 48"	2448	\$1,305	\$1,960
30" x 30"	3030	\$1,025	\$1,540
30" x 36"	3036	\$1,220	\$1,830
30" x 42"	3042	\$1,425	\$2,140
Six		Grade 1	Grade 2
24" x 36"	2436	\$1,176	\$1,764
24" x 42"	2442	\$1,374	\$2,064
24" x 48"	2448	\$1,566	\$2,352
30" x 30"	3030	\$1,230	\$1,848
30" x 36"	3036	\$1,464	\$2,196
30" x 42"	3042	\$1,710	\$2,568

RETURN TOP

TOPS AND BASES ARE SPECIFIED AND SOLD SEPARATELY.

4. Size (Cont.)

Returntop Size (D x W)	Code	Price	
Seven		Grade 1	Grade 2
24" x 36"	2436	\$1,372	\$2,058
24" x 42"	2442	\$1,603	\$2,408
24" x 48"	2448	\$1,827	\$2,744
30" x 30"	3030	\$1,435	\$2,156
30" x 36"	3036	\$1,708	\$2,562
30" x 42"	3042	\$1,995	\$2,996
Eight		Grade 1	Grade 2
24" x 36"	2436	\$1,568	\$2,352
24" x 42"	2442	\$1,832	\$2,752
24" x 48"	2448	\$2,088	\$3,136
30" x 30"	3030	\$1,640	\$2,464
30" x 36"	3036	\$1,952	\$2,928
30" x 42"	3042	\$2,280	\$3,424

EFFECTIVE OCTOBER 17, 2022

5. Grommets

Grommet Location	Code	Price	
None	GPR00	+ \$0	
One Seat			
Left	GPR01	+ \$30	
Right	GPR03	+ \$30	
Left and Right	GPR05	+ \$60	
Two Seats			
Left	GPR01	+ \$60	
Right	GPR03	+ \$60	
Left and Right	GPR05	+ \$120	
Three Seats			
Left	GPR01	+ \$90	
Right	GPR03	+ \$90	
Left and Right	GPR05	+ \$180	
Four Seats			
Left	GPR01	+ \$120	
Right	GPR03	+ \$120	
Left and Right	GPR05	+ \$240	
Five Seats			
Left	GPR01	+ \$150	
Right	GPR03	+ \$150	
Left and Right	GPR05	+ \$300	
Six Seats			
Left	GPR01	+ \$180	
Right	GPR03	+ \$180	
Left and Right	GPR05	+ \$360	
Seven Seats			
Left	GPR01	+ \$210	
Right	GPR03	+ \$210	
Left and Right	GPR05	+ \$420	
Eight Seats			
Left	GPR01	+ \$240	
Right	GPR03	+ \$240	
Left and Right	GPR05	+ \$480	
Grommet Color	Code	Price	
Black	GC01	+ \$0	
White	GC02	+ \$0	

EFFECTIVE OCTOBER 17, 2022

1. Product

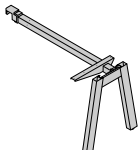
Product Type	Code	Price	
Return Base	3025	Priced by Quantity	

Orientation	Code	Price	
Single-Sided	SS	Priced by Quantity	
Back-to-Back	BB	Priced by Quantity	

Seated Postions	Code	Price	
Single-Sided			
One Seat	SP1	Priced by Quantity	
Two Seats	SP2	Priced by Quantity	
Three Seats	SP3	Priced by Quantity	
Four Seats	SP4	Priced by Quantity	

Back-to-Back			
Two Seats	SP2	Priced by Quantity	
Four Seats	SP4	Priced by Quantity	
Six Seats	SP6	Priced by Quantity	
Eight Seats	SP8	Priced By Quantity	

Return Quantity	Code	Price	
One	RP1	\$560	
Two	RP2	\$1,120	
Three	RP3	\$1,680	
Four	RP4	\$2,240	
Five	RP5	\$2,800	
Six	RP6	\$3,360	
Seven	RP7	\$3,920	
Eight	RP8	\$4,480	

Number of returns cannot exceed the number of seats.

RETURN BASE

TOPS AND BASES ARE SPECIFIED AND SOLD SEPARATELY.

2. Size

Returntop Size (D x W)	Code	Price	
No Return	TN0	+ \$0	
24" x 36"	TN2436	+ \$0	
24" x 42"	TN2442	+ \$0	
24" x 48"	TN2448	+ \$0	
30" x 30"	TN3030	+ \$0	
30" x 36"	TN3036	+ \$0	
30" x 42"	TN3042	+ \$0	

Return bases require the specification of a returntop size. Bases take their size from their corresponding top size.

1. Product

Product Type	Code	Price
Screen	3023	Priced By Screen Size

2. Matching Benching

Orientation	Code	Price
Single-Sided	SS	Priced By Screen Size
Back-to-Back	BB	Priced By Screen Size

Seated Positions	Code	Price
Single-Sided		

One Seat	SP1	Priced By Screen Size
Two Seats	SP2	Priced By Screen Size
Three Seats	SP3	Priced By Screen Size
Four Seats	SP4	Priced By Screen Size

Back-to-Back		
---------------------	--	--

Two Seats	SP2	Priced by Screen Size
Four Seats	SP4	Priced by Screen Size
Six Seats	SP6	Priced by Screen Size
Eight Seats	SP8	Priced by Screen Size

Bench Top Size	Code	Price
----------------	------	-------

None	TZ0	Priced by Screen Size
24" x 48"	TZ2448	Priced by Screen Size
24" x 54"	TZ2454	Priced by Screen Size
24" x 60"	TZ2460	Priced by Screen Size
24" x 66"	TZ2466	Priced by Screen Size
24" x 72"	TZ2472	Priced by Screen Size
30" x 48"	TZ3048	Priced by Screen Size
30" x 54"	TZ3054	Priced by Screen Size
30" x 60"	TZ3060	Priced by Screen Size
30" x 66"	TZ3066	Priced by Screen Size
30" x 72"	TZ3072	Priced by Screen Size

Single-sided orientation comes standard with edge mounts. Back-to-back orientation includes the cost of Prise-specific screen mounts.

Screens require the specification of a bench top size. Screen length may not exceed bench top length.

3. Material

Screen Material	Code	Price
Frosted Acrylic	DT101	Priced by Screen Size
Fabric	DT701	Priced by Screen Size
Markerboard	DT301	Priced by Screen Size

SCREENS

4. Size

Screen Size (H x L)	Code	Price		
One Seat, Single-Sided		Acrylic	Fabric	Markerboard
12" x 48"	DS1248	\$346	\$408	\$301
12" x 54"	DS1254	\$380	\$428	\$327
12" x 60"	DS1260	\$455	\$491	\$396
12" x 66"	DS1266	\$487	\$513	\$422
12" x 72"	DS1272	\$519	\$537	\$448
18" x 48"	DS1848	\$475	\$534	\$404
18" x 54"	DS1854	\$522	\$564	\$444
18" x 60"	DS1860	\$615	\$634	\$525
18" x 66"	DS1866	\$617	\$666	\$565
18" x 72"	DS1872	\$659	\$697	\$607
24" x 48"	DS2448	\$544	\$571	\$509
24" x 54"	DS2454	\$616	\$623	\$563
24" x 60"	DS2460	\$701	\$725	\$657
24" x 66"	DS2466	\$757	\$789	\$709
24" x 72"	DS2472	\$815	\$863	\$761
Two Seat, Single-Sided		Acrylic	Fabric	Markerboard
12" x 48"	DS1248	\$692	\$816	\$602
12" x 54"	DS1254	\$760	\$856	\$654
12" x 60"	DS1260	\$910	\$982	\$792
12" x 66"	DS1266	\$974	\$1,026	\$844
12" x 72"	DS1272	\$1,038	\$1,074	\$896
18" x 48"	DS1848	\$950	\$1,068	\$808
18" x 54"	DS1854	\$1,044	\$1,128	\$888
18" x 60"	DS1860	\$1,230	\$1,268	\$1,050
18" x 66"	DS1866	\$1,234	\$1,332	\$1,130
18" x 72"	DS1872	\$1,318	\$1,394	\$1,214
24" x 48"	DS2448	\$1,088	\$1,142	\$1,018
24" x 54"	DS2454	\$1,232	\$1,246	\$1,126
24" x 60"	DS2460	\$1,402	\$1,450	\$1,314
24" x 66"	DS2466	\$1,514	\$1,578	\$1,418
24" x 72"	DS2472	\$1,630	\$1,726	\$1,522

4. Size (Cont.)

Screen Size (H x L)	Code	Price		
Three Seats, Single-Sided		Acrylic	Fabric	Markerboard
12" x 48"	DS1248	\$1,038	\$1,224	\$903
12" x 54"	DS1254	\$1,140	\$1,284	\$981
12" x 60"	DS1260	\$1,365	\$1,473	\$1,188
12" x 66"	DS1266	\$1,461	\$1,539	\$1,266
12" x 72"	DS1272	\$1,557	\$1,611	\$1,344
18" x 48"	DS1848	\$1,425	\$1,602	\$1,212
18" x 54"	DS1854	\$1,566	\$1,692	\$1,332
18" x 60"	DS1860	\$1,845	\$1,902	\$1,575
18" x 66"	DS1866	\$1,851	\$1,998	\$1,695
18" x 72"	DS1872	\$1,977	\$2,091	\$1,821
24" x 48"	DS2448	\$1,632	\$1,713	\$1,527
24" x 54"	DS2454	\$1,848	\$1,869	\$1,689
24" x 60"	DS2460	\$2,103	\$2,175	\$1,971
24" x 66"	DS2466	\$2,271	\$2,367	\$2,127
24" x 72"	DS2472	\$2,445	\$2,589	\$2,283
Four Seats, Single-Sided		Acrylic	Fabric	Markerboard
12" x 48"	DS1248	\$1,384	\$1,632	\$1,204
12" x 54"	DS1254	\$1,520	\$1,712	\$1,308
12" x 60"	DS1260	\$1,820	\$1,964	\$1,584
12" x 66"	DS1266	\$1,948	\$2,052	\$1,688
12" x 72"	DS1272	\$2,076	\$2,148	\$1,792
18" x 48"	DS1848	\$1,900	\$2,136	\$1,616
18" x 54"	DS1854	\$2,088	\$2,256	\$1,776
18" x 60"	DS1860	\$2,460	\$2,536	\$2,100
18" x 66"	DS1866	\$2,468	\$2,664	\$2,260
18" x 72"	DS1872	\$2,636	\$2,788	\$2,428
24" x 48"	DS2448	\$2,176	\$2,284	\$2,036
24" x 54"	DS2454	\$2,464	\$2,492	\$2,252
24" x 60"	DS2460	\$2,804	\$2,900	\$2,628
24" x 66"	DS2466	\$3,028	\$3,156	\$2,836
24" x 72"	DS2472	\$3,260	\$3,452	\$3,044

4. Size (Cont.)

Screen Size (H x L)	Code	Price		
Two Seats, Back-to-Back		Acrylic	Fabric	Markerboard
12" x 48"	DS1248	\$258	\$320	\$213
12" x 54"	DS1254	\$292	\$340	\$239
12" x 60"	DS1260	\$323	\$359	\$264
12" x 66"	DS1266	\$355	\$381	\$290
12" x 72"	DS1272	\$387	\$405	\$316
18" x 48"	DS1848	\$387	\$446	\$316
18" x 54"	DS1854	\$434	\$476	\$356
18" x 60"	DS1860	\$483	\$502	\$393
18" x 66"	DS1866	\$485	\$534	\$433
18" x 72"	DS1872	\$527	\$565	\$475
24" x 48"	DS2448	\$456	\$483	\$421
24" x 54"	DS2454	\$528	\$535	\$475
24" x 60"	DS2460	\$569	\$593	\$525
24" x 66"	DS2466	\$625	\$657	\$577
24" x 72"	DS2472	\$683	\$731	\$629
Four Seats, Back-to-Back		Acrylic	Fabric	Markerboard
12" x 48"	DS1248	\$516	\$640	\$426
12" x 54"	DS1254	\$584	\$680	\$478
12" x 60"	DS1260	\$646	\$718	\$528
12" x 66"	DS1266	\$710	\$762	\$580
12" x 72"	DS1272	\$774	\$810	\$632
18" x 48"	DS1848	\$774	\$892	\$632
18" x 54"	DS1854	\$868	\$952	\$712
18" x 60"	DS1860	\$966	\$1,004	\$786
18" x 66"	DS1866	\$970	\$1,068	\$866
18" x 72"	DS1872	\$1,054	\$1,130	\$950
24" x 48"	DS2448	\$912	\$966	\$842
24" x 54"	DS2454	\$1,056	\$1,070	\$950
24" x 60"	DS2460	\$1,138	\$1,186	\$1,050
24" x 66"	DS2466	\$1,250	\$1,314	\$1,154
24" x 72"	DS2472	\$1,366	\$1,462	\$1,258

EFFECTIVE OCTOBER 17, 2022

4. Size (Cont.)

Screen Size (H x L)	Code	Price		
Six Seats, Back-to-Back		Acrylic	Fabric	Markerboard
12" x 48"	DS1248	\$774	\$960	\$639
12" x 54"	DS1254	\$876	\$1,020	\$717
12" x 60"	DS1260	\$969	\$1,077	\$792
12" x 66"	DS1266	\$1,065	\$1,143	\$870
12" x 72"	DS1272	\$1,161	\$1,215	\$948
18" x 48"	DS1848	\$1,161	\$1,338	\$948
18" x 54"	DS1854	\$1,302	\$1,428	\$1,068
18" x 60"	DS1860	\$1,449	\$1,506	\$1,179
18" x 66"	DS1866	\$1,455	\$1,602	\$1,299
18" x 72"	DS1872	\$1,581	\$1,695	\$1,425
24" x 48"	DS2448	\$1,368	\$1,449	\$1,263
24" x 54"	DS2454	\$1,584	\$1,605	\$1,425
24" x 60"	DS2460	\$1,707	\$1,779	\$1,575
24" x 66"	DS2466	\$1,875	\$1,971	\$1,731
24" x 72"	DS2472	\$2,049	\$2,193	\$1,887
Eight Seats, Back-to-Back		Acrylic	Fabric	Markerboard
12" x 48"	DS1248	\$1,032	\$1,280	\$852
12" x 54"	DS1254	\$1,168	\$1,360	\$956
12" x 60"	DS1260	\$1,292	\$1,436	\$1,056
12" x 66"	DS1266	\$1,420	\$1,524	\$1,160
12" x 72"	DS1272	\$1,548	\$1,620	\$1,264
18" x 48"	DS1848	\$1,548	\$1,784	\$1,264
18" x 54"	DS1854	\$1,736	\$1,904	\$1,424
18" x 60"	DS1860	\$1,932	\$2,008	\$1,572
18" x 66"	DS1866	\$1,940	\$2,136	\$1,732
18" x 72"	DS1872	\$2,108	\$2,260	\$1,900
24" x 48"	DS2448	\$1,824	\$1,932	\$1,684
24" x 54"	DS2454	\$2,112	\$2,140	\$1,900
24" x 60"	DS2460	\$2,276	\$2,372	\$2,100
24" x 66"	DS2466	\$2,500	\$2,628	\$2,308
24" x 72"	DS2472	\$2,732	\$2,924	\$2,516

1. Power

Product Type	Code	Price
Data Pack	3029 PDP	+ \$55

Power Beam

SINGLE-SIDED | BACK-TO-BACK
INFEEED COVER | WIRE MANAGEMENT
POWER | DATA | DUPLEXES

eBEAM

POWER + DATA BEAM

Power innovation.

eBEAM is a straightforward, streamlined solution for adding power to your workstations. With adaptable legs, multiple beam lengths and cable management options that make it practically mess-free, eBEAM is simply powerful (and powerfully simple).

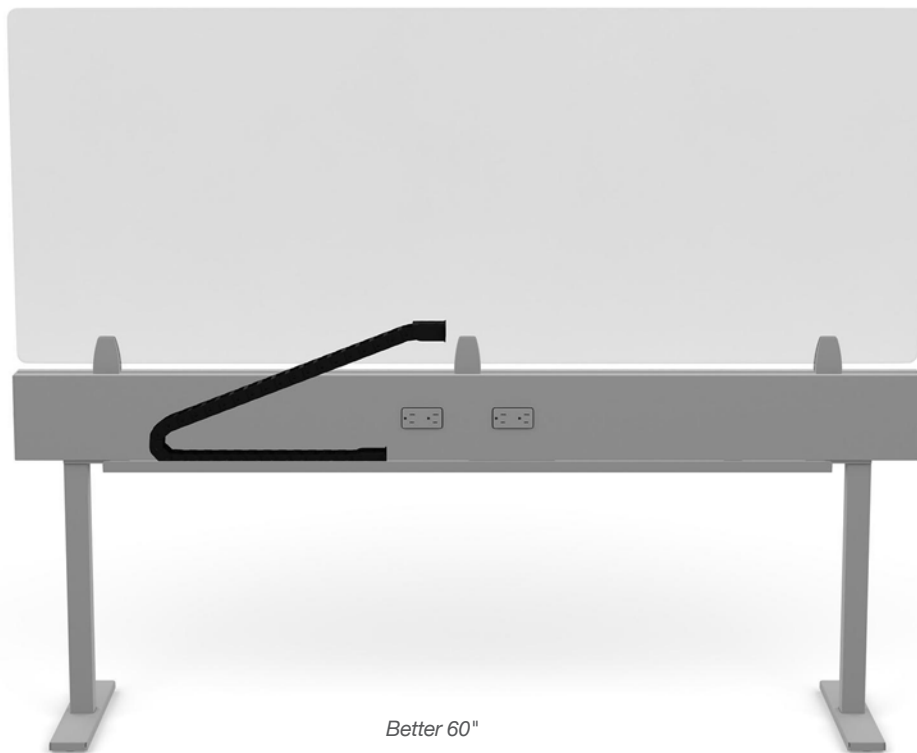

EFFECTIVE OCTOBER 17, 2022

Featured Models

60" 2-SEAT WITH NO ACCESSORIES :: \$1,225

60" beam, back to back, 2-seat, 72" conduit infeed, four duplex receptacles, no accessories

60" 2-SEAT WITH ACCESSORIES :: \$2,298

60" beam, back to back, 2-seat, 72" conduit infeed, four duplex receptacles, horizontal wire trays, vertical wire manager, 24" x 60" frosted acrylic screen

60" 4-SEAT WITH ACCESSORIES :: \$4,343

60" beam, back to back, 4-seat, 72" conduit infeed, four duplex receptacles, horizontal wire tray, vertical wire manager, infeed cover, 24" x 60" grade 1 fabric screen

Features

- Quick and easy installation in less than 10 minutes
- Cable management accessories ensure an uncluttered look
- Responsive, adaptable design includes moveable leg positions
- Fits perfectly with any static or height-adjustable tabletop
- Seamless screen integration for providing privacy
- Beam sizes: 48," 60" and 72" (W) x 24 inches (H)
- Screen height options: 12", 18", 24" and 30"
- Screen material options: Clear acrylic, frosted acrylic, fabric and whiteboard
- 10 standard configurations.
Single-sided: 1-seat, 2-seat, 3-seat, 4-seat and 5-seat.
Back-to-back: 2-seat, 4-seat, 6-seat, 8-seat and 10-seat with adjustable leg positions
- 4-circuit, 8-wire power system included with standard or optional controlled duplex receptacles
- Power system is UL183 Listed
- Toolless power installation
- Optional horizontal, vertical and infeed wire management
- Data adapter kit included
- Data modules not included. See page 523 for a list of compatible modules.
- Tabletops that are 2" undersized are available and strongly recommended for use with eBEAM

1. Product

Product Type	Code	Price
Power Beam	3242	Priced by Seated Positions



Beam Length	Code	Price
48" W Power Beam	TW48	Priced by Seated Positions
60" W Power Beam	TW60	Priced by Seated Positions
72" W Power Beam	TW72	Priced by Seated Positions

POWER BEAM

1. Product (Cont.)

Orientation	Code	Price
Single-Sided	SS	Priced by Seated Positions
Back-to-Back	BB	Priced by Seated Positions

Seated Position	Code	Price
Single-Sided		
1-Seat, 48"	SP1	\$1,105
1-Seat, 60"	SP1	\$1,148
1-Seat, 72"	SP1	\$1,189
2-Seat, 48"	SP2	\$1,855
2-Seat, 60"	SP2	\$1,932
2-Seat, 72"	SP2	\$2,008
3-Seat, 48"	SP3	\$2,708
3-Seat, 60"	SP3	\$2,822
3-Seat, 72"	SP3	\$2,938
4-Seat, 48"	SP4	\$3,560
4-Seat, 60"	SP4	\$3,713
4-Seat, 72"	SP4	\$3,866
5-Seat, 48"	SP5	\$4,413
5-Seat, 60"	SP5	\$4,605
5-Seat, 72"	SP5	\$4,796
Back-to-Back		
2-Seat, 48"	SP2	\$1,182
2-Seat, 60"	SP2	\$1,225
2-Seat, 72"	SP2	\$1,266
4-Seat, 48"	SP4	\$2,009
4-Seat, 60"	SP4	\$2,086
4-Seat, 72"	SP4	\$2,162
6-Seat, 48"	SP6	\$2,939
6-Seat, 60"	SP6	\$3,053
6-Seat, 72"	SP6	\$3,169
8-Seat, 48"	SP8	\$3,869
8-Seat, 60"	SP8	\$4,022
8-Seat, 72"	SP8	\$4,175
10-Seat, 48"	SP10	\$4,798
10-Seat, 60"	SP10	\$4,990
10-Seat, 72"	SP10	\$5,183

Beams come standard with a standard 72" power infeed.

2. Finish

Paint Color	Code	Price
Silver	BF01	+ \$0
White	BF02	+ \$0
Black	BF03	+ \$0

3. Wire Management

Wire Management Type	Code	Price
No Wire Management	WM00	+ \$0

Horizontal Wire Tray

1-Seat	WM01	+ \$105
2-Seat	WM01	+ \$210
3-Seat	WM01	+ \$315
4-Seat	WM01	+ \$420
5-Seat	WM01	+ \$525
6-Seat	WM01	+ \$630
8-Seat	WM01	+ \$840
10-Seat	WM01	+ \$1,050

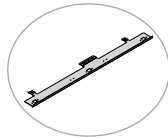

Horizontal Wire Tray And Vertical Wire Manager

1-Seat	WM06	+ \$210
2-Seat	WM06	+ \$420
3-Seat	WM06	+ \$630
4-Seat	WM06	+ \$840
5-Seat	WM06	+ \$1,050
6-Seat	WM06	+ \$1,260
8-Seat	WM06	+ \$1,680
10-Seat	WM06	+ \$2,100

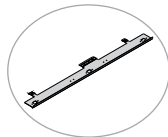

Infeed Cover	Code	Price
--------------	------	-------

No Power Infeed Cover	VLC0	\$0
-----------------------	------	-----

Power Infeed Cover	VLC1	+ \$63
--------------------	------	--------

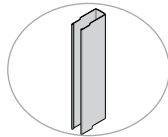

POWER BEAM

4. Electrical

Type and Length	Code	Price
-----------------	------	-------

Power Infeed

No Infeed	NPIF	- \$147
72" Conduit	PIC72	+ \$0
72" Liquidtight	PIL72	+ \$12
144" Conduit	PIC144	+ \$47
144" Liquidtight	PIL144	+ \$59

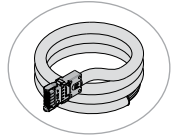

Type and Length	Code	Price
-----------------	------	-------

No Power, Single-Sided

1-Seat	NPOW	- \$283
2-Seat	NPOW	- \$507
3-Seat	NPOW	- \$730
4-Seat	NPOW	- \$954
5-Seat	NPOW	- \$1,177

No Power, Back-to-Back

2-Seat	NPOW	- \$283
4-Seat	NPOW	- \$507
6-Seat	NPOW	- \$730
8-Seat	NPOW	- \$954
10-Seat	NPOW	- \$1,177

Duplexes	Code	Price
----------	------	-------

Standard Duplex Receptacles, Two Per Seat	SDUP	+ \$0
---	------	-------

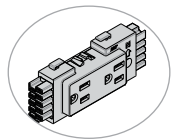

No Duplexes

1-Seat	NDUP	- \$79
2-Seat	NDUP	- \$158
3-Seat	NDUP	- \$237
4-Seat	NDUP	- \$316
5-Seat	NDUP	- \$395
6-Seat	NDUP	- \$474
8-Seat	NDUP	- \$632
10-Seat	NDUP	- \$790

Duplex receptacle color will match beam color. When power is specified in beam, it includes duplexes for circuits 1, 2, 3, and 4. For other combinations of duplexes and controlled duplexes, specify "no duplexes" and order as standalone components.

1. Product

Product Type	Code	Price
Screen for EBEAM	3243	Priced by Size
Beam	Code	Price
48"	TW48	Priced by Size
60"	TW60	Priced by Size
72"	TW72	Priced by Size
Beam Orientation	Code	Price
Single-Sided	SS	Priced by Size
Back-to-Back	BB	Priced by Size
Seated Positions	Code	Price
Single-Sided		
1-Seat	SP1	Priced by Size
2-Seat	SP2	Priced by Size
3-Seat	SP3	Priced by Size
4-Seat	SP4	Priced by Size
5-Seat	SP5	Priced by Size
Back-to-Back		
2-Seat	SP2	Priced by Size
4-Seat	SP4	Priced by Size
6-Seat	SP6	Priced by Size
8-Seat	SP8	Priced by Size
10-Seat	SP10	Priced by Size

2. Material

Material Type	Code	Price
Motif Fabric	DT701	Priced by Size
Sector Frosted Acrylic	DT101	Priced by Size
Sector Clear Acrylic	DT101C	Priced by Size
Doodle Markerboard	DT301	Priced by Size
Grade	Code	Price
Fabric/Vinyl Grade 1	FG1/VG1	Priced by Size
Fabric/Vinyl Grade 2	FG2/VG2	Priced by Size
Fabric/Vinyl Grade 3	FG3/VG3	Priced by Size
Fabric/Vinyl Grade 4	FG4/VG4	Priced by Size
Fabric/Vinyl Grade 5	FG5/VG5	Priced by Size

The following prices are for grade 1 fabrics/vinyls only. For higher grade pricing, add the appropriate upcharge from the Motif price list.

POWER BEAM SCREENS

3. Size

Screen Size (H x L)	Code	Grade 1 Price		
1-Seat, Single-Sided		Acrylic	Fabric	Markerboard
12" x 48"	DS1248	\$314	\$376	\$269
18" x 48"	DS1848	\$443	\$502	\$372
24" x 48"	DS2448	\$512	\$539	\$477
30" x 48"	DS3048	N/A	\$666	\$565
12" x 60"	DS1260	\$407	\$443	\$348
18" x 60"	DS1860	\$567	\$586	\$477
24" x 60"	DS2460	\$653	\$677	\$609
30" x 60"	DS3060	N/A	\$801	\$719
12" x 72"	DS1272	\$471	\$489	\$400
18" x 72"	DS1872	\$611	\$649	\$559
24" x 72"	DS2472	\$767	\$815	\$713
30" x 72"	DS3072	N/A	\$841	\$845
2-Seat, Single-Sided		Acrylic	Fabric	Markerboard
12" x 48"	DS1248	\$628	\$752	\$538
18" x 48"	DS1848	\$886	\$1,004	\$744
24" x 48"	DS2448	\$1,024	\$1,078	\$954
30" x 48"	DS3048	N/A	\$1,332	\$1,130
12" x 60"	DS1260	\$814	\$886	\$696
18" x 60"	DS1860	\$1,134	\$1,172	\$954
24" x 60"	DS2460	\$1,306	\$1,354	\$1,218
30" x 60"	DS3060	N/A	\$1,602	\$1,438
12" x 72"	DS1272	\$942	\$978	\$800
18" x 72"	DS1872	\$1,222	\$1,298	\$1,118
24" x 72"	DS2472	\$1,534	\$1,630	\$1,426
30" x 72"	DS3072	N/A	\$1,682	\$1,690
3-Seat, Single-Sided		Acrylic	Fabric	Markerboard
12" x 48"	DS1248	\$942	\$1,128	\$807
18" x 48"	DS1848	\$1,329	\$1,506	\$1,116
24" x 48"	DS2448	\$1,536	\$1,617	\$1,431
30" x 48"	DS3048	N/A	\$1,998	\$1,695
12" x 60"	DS1260	\$1,221	\$1,329	\$1,044
18" x 60"	DS1860	\$1,701	\$1,758	\$1,431
24" x 60"	DS2460	\$1,959	\$2,031	\$1,827
30" x 60"	DS3060	N/A	\$2,403	\$2,157
12" x 72"	DS1272	\$1,413	\$1,467	\$1,200
18" x 72"	DS1872	\$1,833	\$1,947	\$1,677
24" x 72"	DS2472	\$2,301	\$2,445	\$2,139
30" x 72"	DS3072	N/A	\$2,523	\$2,535

4. Size (Cont.)

Screen Size (H x L)	Code	Grade 1 Price		
4-Seat, Single-Sided		Acrylic	Fabric	Markerboard
12" x 48"	DS1248	\$1,256	\$1,504	\$1,076
18" x 48"	DS1848	\$1,772	\$2,008	\$1,488
24" x 48"	DS2448	\$2,048	\$2,156	\$1,908
30" x 48"	DS3048	N/A	\$2,664	\$2,260
12" x 60"	DS1260	\$1,628	\$1,772	\$1,392
18" x 60"	DS1860	\$2,268	\$2,344	\$1,908
24" x 60"	DS2460	\$2,612	\$2,708	\$2,436
30" x 60"	DS3060	N/A	\$3,204	\$2,876
12" x 72"	DS1272	\$1,884	\$1,956	\$1,600
18" x 72"	DS1872	\$2,444	\$2,596	\$2,236
24" x 72"	DS2472	\$3,068	\$3,260	\$2,852
30" x 72"	DS3072	N/A	\$3,364	\$3,380
5-Seat, Single-Sided		Acrylic	Fabric	Markerboard
12" x 48"	DS1248	\$1,570	\$1,880	\$1,345
18" x 48"	DS1848	\$2,215	\$2,510	\$1,860
24" x 48"	DS2448	\$2,560	\$2,695	\$2,385
30" x 48"	DS3048	N/A	\$3,330	\$2,825
12" x 60"	DS1260	\$2,035	\$2,215	\$1,740
18" x 60"	DS1860	\$2,835	\$2,930	\$2,385
24" x 60"	DS2460	\$3,265	\$3,385	\$3,045
30" x 60"	DS3060	N/A	\$4,005	\$3,595
12" x 72"	DS1272	\$2,355	\$2,445	\$2,000
18" x 72"	DS1872	\$3,055	\$3,245	\$2,795
24" x 72"	DS2472	\$3,835	\$4,075	\$3,565
30" x 72"	DS3072	N/A	\$4,205	\$4,225
2-Seat, Back-to-Back		Acrylic	Fabric	Markerboard
12" x 48"	DS1248	\$314	\$376	\$269
18" x 48"	DS1848	\$443	\$502	\$372
24" x 48"	DS2448	\$512	\$539	\$477
30" x 48"	DS3048	N/A	\$666	\$565
12" x 60"	DS1260	\$407	\$443	\$348
18" x 60"	DS1860	\$567	\$586	\$477
24" x 60"	DS2460	\$653	\$677	\$609
30" x 60"	DS3060	N/A	\$801	\$719
12" x 72"	DS1272	\$471	\$489	\$400
18" x 72"	DS1872	\$611	\$649	\$559
24" x 72"	DS2472	\$767	\$815	\$713
30" x 72"	DS3072	N/A	\$841	\$845

4. Size (Cont.)

Screen Size (H x L)	Code	Grade 1 Price		
4-Seat, Back-to-Back		Acrylic	Fabric	Markerboard
12" x 48"	DS1248	\$628	\$752	\$538
18" x 48"	DS1848	\$886	\$1,004	\$744
24" x 48"	DS2448	\$1,024	\$1,078	\$954
30" x 48"	DS3048	N/A	\$1,332	\$1,130
12" x 60"	DS1260	\$814	\$886	\$696
18" x 60"	DS1860	\$1,134	\$1,172	\$954
24" x 60"	DS2460	\$1,306	\$1,354	\$1,218
30" x 60"	DS3060	N/A	\$1,602	\$1,438
12" x 72"	DS1272	\$942	\$978	\$800
18" x 72"	DS1872	\$1,222	\$1,298	\$1,118
24" x 72"	DS2472	\$1,534	\$1,630	\$1,426
30" x 72"	DS3072	N/A	\$1,682	\$1,690
6-Seat, Back-to-Back		Acrylic	Fabric	Markerboard
12" x 48"	DS1248	\$942	\$1,128	\$807
18" x 48"	DS1848	\$1,329	\$1,506	\$1,116
24" x 48"	DS2448	\$1,536	\$1,617	\$1,431
30" x 48"	DS3048	N/A	\$1,998	\$1,695
12" x 60"	DS1260	\$1,221	\$1,329	\$1,044
18" x 60"	DS1860	\$1,701	\$1,758	\$1,431
24" x 60"	DS2460	\$1,959	\$2,031	\$1,827
30" x 60"	DS3060	N/A	\$2,403	\$2,157
12" x 72"	DS1272	\$1,413	\$1,467	\$1,200
18" x 72"	DS1872	\$1,833	\$1,947	\$1,677
24" x 72"	DS2472	\$2,301	\$2,445	\$2,139
30" x 72"	DS3072	N/A	\$2,523	\$2,535
8-Seat, Back-to-Back		Acrylic	Fabric	Markerboard
12" x 48"	DS1248	\$1,256	\$1,504	\$1,076
18" x 48"	DS1848	\$1,772	\$2,008	\$1,488
24" x 48"	DS2448	\$2,048	\$2,156	\$1,908
30" x 48"	DS3048	N/A	\$2,664	\$2,260
12" x 60"	DS1260	\$1,628	\$1,772	\$1,392
18" x 60"	DS1860	\$2,268	\$2,344	\$1,908
24" x 60"	DS2460	\$2,612	\$2,708	\$2,436
30" x 60"	DS3060	N/A	\$3,204	\$2,876
12" x 72"	DS1272	\$1,884	\$1,956	\$1,600
18" x 72"	DS1872	\$2,444	\$2,596	\$2,236
24" x 72"	DS2472	\$3,068	\$3,260	\$2,852
30" x 72"	DS3072	N/A	\$3,364	\$3,380

EFFECTIVE OCTOBER 17, 2022

4. Size (Cont.)

Screen Size (H x L)	Code	Grade 1 Price		
		Acrylic	Fabric	Markerboard
10-Seat, Back-to-Back				
12" x 48"	DS1248	\$1,570	\$1,880	\$1,345
18" x 48"	DS1848	\$2,215	\$2,510	\$1,860
24" x 48"	DS2448	\$2,560	\$2,695	\$2,385
30" x 48"	DS3048	N/A	\$3,330	\$2,825
12" x 60"	DS1260	\$2,035	\$2,215	\$1,740
18" x 60"	DS1860	\$2,835	\$2,930	\$2,385
24" x 60"	DS2460	\$3,265	\$3,385	\$3,045
30" x 60"	DS3060	N/A	\$4,005	\$3,595
12" x 72"	DS1272	\$2,355	\$2,445	\$2,000
18" x 72"	DS1872	\$3,055	\$3,245	\$2,795
24" x 72"	DS2472	\$3,835	\$4,075	\$3,565
30" x 72"	DS3072	N/A	\$4,205	\$4,225

SPECIFICATIONS

	3242 TW42 42" Beam	3242 TW60 60" Beam	3242 TW72 72" Beam
Dimensions			
Beam Length (With End Cap)	48.75"	60.75"	72.75"
Beam Height	5.8"	5.8"	5.8"
Beam Width	2.5"	2.5"	2.5"
Overall Height	24.1"	24.1"	24.1"
Height From Floor to Beam	18.3"	18.3"	18.3"
Leg Width	2.5"	2.5"	2.5"
Foot Width	1.6"	1.6"	1.6"
Foot Length	14.5"	14.5"	14.5"
Length From End to Duplex	19.7"	25.7"	31.7"

5. Clamp Color

Paint Color	Code	Price
Silver	BF01	+ \$0
White	BF02	+ \$0
Black	BF03	+ \$0

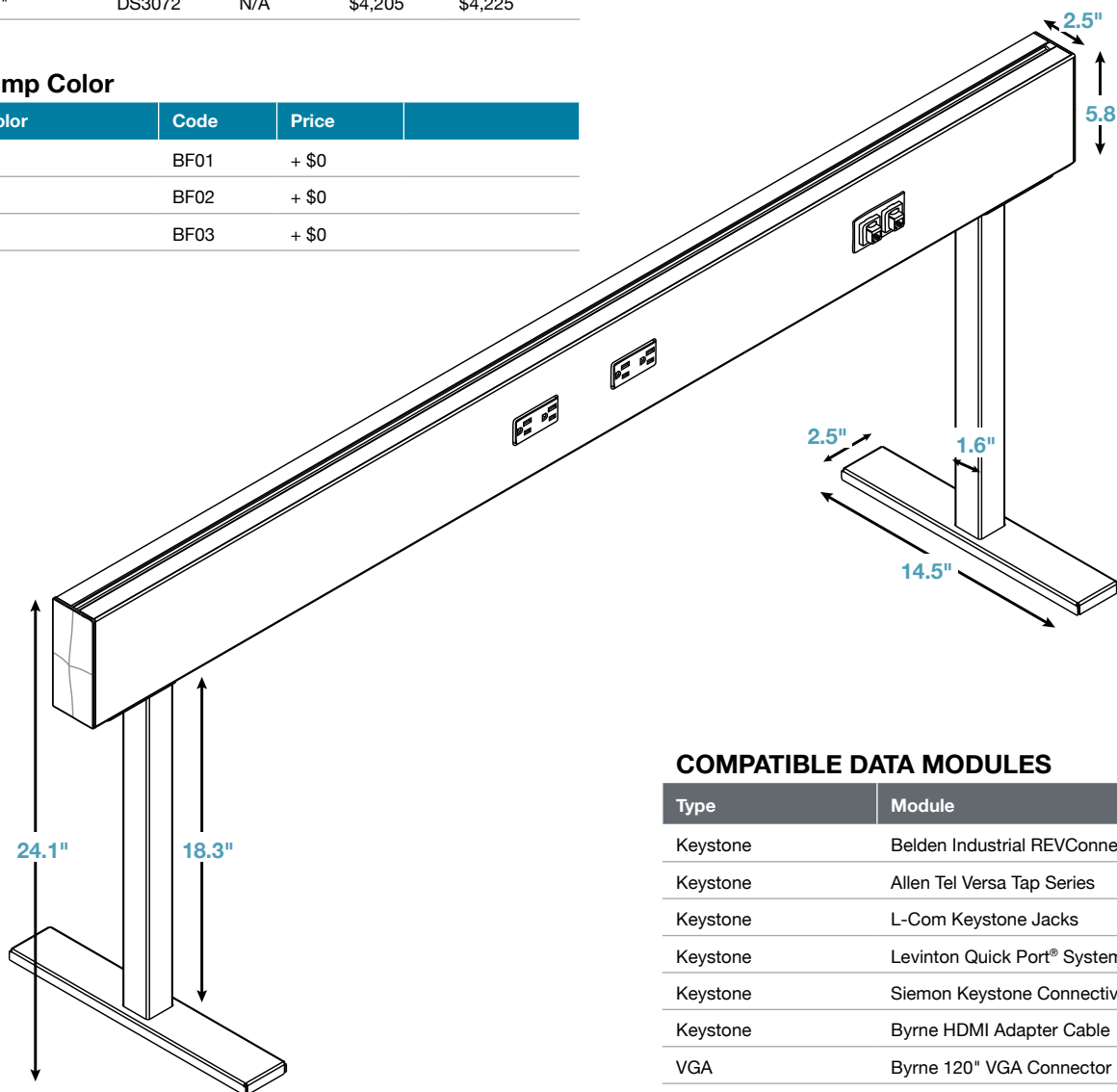

COMPATIBLE DATA MODULES

Type	Module
Keystone	Belden Industrial REVConnect
Keystone	Allen Tel Versa Tap Series
Keystone	L-Com Keystone Jacks
Keystone	Levinton Quick Port® System Adapters and Jacks
Keystone	Siemon Keystone Connectivity Solutions
Keystone	Byrne HDMI Adapter Cable
VGA	Byrne 120" VGA Connector

EFFECTIVE OCTOBER 17, 2022

1. Product

Category	Code	Price
Stand-Alone Components for Power Beams	3249	Priced by Type
Type	Code	Price
Electrical		

Duplex Receptacle	ATC04	\$40	
-------------------	-------	------	---

Wire Management

Horizontal Wire Tray	ATC01 WM01	+ \$105	
----------------------	---------------	---------	---

Horizontal Wire Tray and Vertical Wire Manager	ATC01 WM06	+ \$210	
--	---------------	---------	--

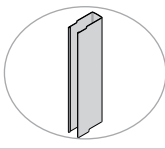
Power Infeed Cover	ATC02 VLC1	+ \$63	
--------------------	---------------	--------	---

2. Circuit (For Duplexes Only)

Circuit Number	Code	Price
Circuit 1	DC1	+ \$0
Circuit 2	DC2	+ \$0
Circuit 3	DC3	+ \$0
Circuit 4	DC4	+ \$0

Title 24 (Controlled)

Circuit 1	DC1C	+ \$7
Circuit 2	DC2C	+ \$7
Circuit 3	DC3C	+ \$7
Circuit 4	DC4C	+ \$7

3. Color

Wire Management Color	Code	Price
Silver	BF01	+ \$0
White	BF02	+ \$0
Black	BF03	+ \$0

Vertical wire managers are only available in black. Color will apply to the horizontal wire tray only.

Screens

WORKSURFACE | MODESTY
FREESTANDING | MOBILE | CAFÉ
SEATING | TRANSACTION | TRIFOLD

Doodle

MARKERBOARD WORKSURFACE SCREEN

Write away (right away).

From big idea-making to simple note-taking, stay on task with a tool that helps you work. Our Doodle markerboards provide essential privacy as a screen while promoting impactful productivity as a convenient place to write.



12" x 23" Middle Mount
Table not included. See [page 471](#) for Tensor.
Chairs not included. See [page 101](#) for Ioniq.

EFFECTIVE OCTOBER 17, 2022

Featured Models

12" x 23" MIDDLE :: \$192

12" x 23" markerboard screen,
middle mount

24" x 60" EDGE :: \$657

24" x 60" markerboard screen,
edge mount

30" x 60" MIDWAY :: \$711

30" x 60" markerboard screen,
midway mount

Features

- Non-ghosting, durable writing surface can withstand endless scribbles and wipes
- Compatible with dry erase and wet erase markers
- Slim, straightforward design mixes well with any workspace
- Height options: 12, 18 and 24 inches; 30 inches available for midway and height-adjustable mounts
- Width options: 17 to 72 inches (in six-inch increments)
- Compatible with most mounts, including edge, middle, top, midway, freestanding, panel and height-adjustable

1. Product

Product Type	Code	Price
Worksurface Screen	3090	Priced by Size

2. Material

Material	Code	Price
Markerboard	DT301	Priced by Size

3. Size

Screen Size (H x W)	Code	Price
17" Wide Side Screen		
12" x 17"	DS1217	\$79
18" x 17"	DS1817	\$114
24" x 17"	DS2417	\$151
23" Wide Side Screen		
12" x 23"	DS1223	\$104
18" x 23"	DS1823	\$155
24" x 23"	DS2423	\$204
29" Wide Side Screen		
12" x 29"	DS1229	\$129
18" x 29"	DS1829	\$194
24" x 29"	DS2429	\$255
24" Wide Screen		
24" x 24"	DS2424	\$204
30" x 24"	DS3024	\$255

MARKERBOARD WORKSURFACE SCREEN

3. Size (Cont.)

Screen Size (H x W)	Code	Price
30" Wide Screen		
24" x 30"	DS2430	\$255
30" x 30"	DS3030	\$319
36" Wide Screen		
12" x 36"	DS1236	\$160
18" x 36"	DS1836	\$239
24" x 36"	DS2436	\$316
30" x 36"	DS3036	\$382
42" Wide Screen		
12" x 42"	DS1242	\$185
18" x 42"	DS1842	\$277
24" x 42"	DS2442	\$368
30" x 42"	DS3042	\$447
48" Wide Screen		
12" x 48"	DS1248	\$213
18" x 48"	DS1848	\$316
24" x 48"	DS2448	\$421
30" x 48"	DS3048	\$509
54" Wide Screen		
12" x 54"	DS1254	\$239
18" x 54"	DS1854	\$356
24" x 54"	DS2454	\$475
30" x 54"	DS3054	\$572
60" Wide Screens		
12" x 60"	DS1260	\$264
18" x 60"	DS1860	\$393
24" x 60"	DS2460	\$525
30" x 60"	DS3060	\$635
66" Wide Screen		
12" x 66"	DS1266	\$290
18" x 66"	DS1866	\$433
24" x 66"	DS2466	\$577
30" x 66"	DS3066	\$697
72" Wide Screen		
12" x 72"	DS1272	\$316
18" x 72"	DS1872	\$475
24" x 72"	DS2472	\$629
30" x 72"	DS3072	\$761

**MARKERBOARD
WORKSURFACE SCREEN**

4. Mount

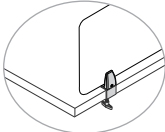
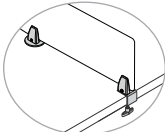
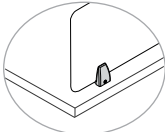
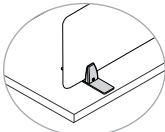
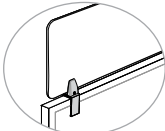
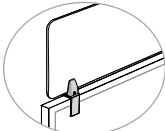
Mount Style	Code	Price	
Protective/Privacy			
Edge Mount Compatibility: 17"-54" Screen Width 12"-24" Screen Height	MT1	+ \$88	
Edge Mount Compatibility: 60"-72" Screen Width 12"-24" Screen Height	MT1	+ \$132	
Middle Mount Compatibility: 17"-29" Screen Width 12"-24" Screen Height	MT2	+ \$88	
Top Mount Compatibility: 17"-54" Screen Width 12"-24" Screen Height	MT3	+ \$56	
Top Mount Compatibility: 60"-72" Screen Width 12"-24" Screen Height	MT3	+ \$84	
Freestanding Mount Compatibility: 17"-54" Screen Width 12"-24" Screen Height	MT4	+ \$88	
Freestanding Mount Compatibility: 60"-72" Screen Width 12"-24" Screen Height	MT4	+ \$132	
Small Panel Mount Compatibility: 1.5"-2.3" Panel Depth 17"-54" Screen Width 12"-24" Screen Height	MT9	+ \$88	
Small Panel Mount Compatibility: 1.5"-2.3" Panel Depth 60"-72" Screen Width 12"-24" Screen Height	MT9	+ \$132	
Large Panel Mount Compatibility: 2.3"-3.7" Panel Depth 17"-54" Screen Width 12"-24" Screen Height	MT10	+ \$88	
Large Panel Mount Compatibility: 2.3"-3.7" Panel Depth 60"-72" Screen Width 12"-24" Screen Height	MT10	+ \$132	

4. Mount (Cont.)

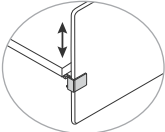
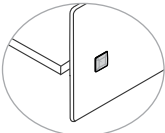
Mount Style	Code	Price	
Protective/Privacy + Modesty			
Height-Adjustable Compatibility: 24"-60" Screen Width 24"-30" Screen Height	MT6	+ \$80	
Midway Compatibility: 17"-54" Screen Width 24"-30" Screen Height	MT5	+ \$38	
Midway Compatibility: 60"-72" Screen Width 24"-30" Screen Height	MT5	+ \$76	

NOTE:

Edge Mounts and Middle Mounts clamp to the work surface and are designed to be used with the standard Exemplis table tops. They will function, as designed, with tops between .9" and 1.5" thick. If the worksurface is less than .9" thick the customer will be responsible to add a spacer to bring the thickness into the allowable range

Modesty

LAMINATE SCREENS

Versatile peace of mind.

We all need our own space. Increase office and employee privacy with our selection of modesty screens that attach right onto our desks and benches. In addition, shield cords, wires and more from sight for a clean and organized workspace.



60" Laminate Modesty Screen
Table not included. See [page 423](#) for Parallon Fixed-Top

EFFECTIVE OCTOBER 17, 2022

Featured Models

48" :: \$415

Modesty Screen, 10" x 48",
grade 1 laminate

60" :: \$491

Modesty Screen, 10" x 60",
grade 1 laminate

72" :: \$593

Modesty Screen, 10" x 72",
grade 1 laminate

Features

- Extra privacy for users
- 28 durable laminate options to fit your style
- Hinged mount

1. Product

Product Type	Code	Price
Modesty Screen	3093	Priced by Size

2. Material

Material Type	Code	Price
Laminate	DT501	Priced by Size

Laminate	Code	Price
Laminate Grade 1		
Ankara Cherry	MPC18	+ \$0
Black	MPC19	+ \$0
Brazilian Walnut	MPC20	+ \$0
Cabinet Maple	MPC21	+ \$0
Driftwood	MPC23	+ \$0
Folkstone Grey	MPC24	+ \$0
Libretti	MPC25	+ \$0
Queenston Oak	MPC26	+ \$0
Sandlewood	MPC27	+ \$0
Walnut Amati	MPC28	+ \$0
White	MPC29	+ \$0

Laminate	Code	Price
Laminate Grade 2		
Neo Walnut	MPC50	+ \$0
Grey Elm	MPC51	+ \$0
Skyline Walnut	MPC15	+ \$0
Kingswood Walnut	MPC53	+ \$0
Uptown Walnut	MPC14	+ \$0
Colombian Walnut	MPC55	+ \$0
Manitoba Maple	MPC56	+ \$0
Tuscan Walnut	MPC57	+ \$0
Field Elm	MPC13	+ \$0
Steel Mesh	MPC59	+ \$0
Portico Teak	MPC60	+ \$0
Platinum	MPC61	+ \$0
Grey	MPC62	+ \$0

WORKSURFACE SCREEN

2. Material (Cont.)

Laminate	Code	Price
Laminate Grade 2		
Frosty White	MPC16	+ \$0
Crisp Linen	MPC64	+ \$0
Classic Linen	MPC17	+ \$0
Designer White	MPC66	+ \$0

3. Size

Screen Size (H x W)	Code	Price	
For Rectangular Tables		Grade 1 Laminate	Grade 2 Laminate
10" x 36"	DS1036	\$288	\$326
10" x 40"	DS1040	\$288	\$381
10" x 42"	DS1042	\$320	\$381
10" x 46"	DS1046	\$320	\$398
10" x 48"	DS1048	\$355	\$398
10" x 52"	DS1052	\$320	\$434
10" x 54"	DS1054	\$388	\$434
10" x 58"	DS1058	\$420	\$470
10" x 60"	DS1060	\$420	\$470
10" x 64"	DS1064	\$454	\$507
10" x 66"	DS1066	\$454	\$507
10" x 70"	DS1070	\$507	\$542
10" x 72"	DS1072	\$507	\$542
For Trapezoid Tables			
10" x 25"	DS1025	\$355	\$398
10" x 31"	DS1031	\$420	\$470

4. Mount

Mount Style	Code	Price
-------------	------	-------

Modesty Screen Mount
 Compatibility:
 36"-72" Screen Width
 10" Screen Height

MT8

+ \$0

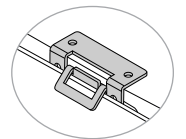

Modesty screens include the cost of the mount.

Motif

FABRIC WORKSURFACE SCREEN

Social distancing with style.

Divide and conquer the challenges of the "new normal" with Motif. Our collection of modern, well-designed privacy and modesty screens help you fashion spaces that are safe, secluded and color coordinated with the entire office.



30" x 60" Screen With Midway Mount
Table not included; see [page 426](#) for Tensor.

EFFECTIVE OCTOBER 17, 2022

Featured Models

12" x 23" EDGE :: \$277

12" x 23" fabric screen, edge mount,
grade 1 textile

30" x 48" HA :: \$690

30" x 48" fabric screen,
height-adjustable mount, grade 1 textile

30" x 60" MIDWAY :: \$793

30" x 60" fabric screen, midway mount,
grade 1 textile

Features

- Get customized privacy with durable fabrics designed to heal from pins, thumbtacks and more
- Find privacy + protection with fabrics that are bleach-cleanable, helping protect against COVID-19
- Eco-friendly, single-piece construction features a HexaCore honeycomb center, providing rigidity with less weight
- Height options include 12, 18, and 24 inches; 30 inches available for midway and height-adjustable mounts
- Width options range from 17 to 72 inches (in six-inch increments)
- Compatible with most mounts, including edge, middle, top, midway, freestanding, panel and height-adjustable

1. Product

Product Type	Code	Price
Screen	3090	Priced by Size

2. Material

Material Type	Code	Price			
Fabric/Vinyl	DT701	Priced by Grade and Size			
Material Grade	Code	12" (H) Price	18" (H) Price	24" (H) Price	30" (H) Price
17" Wide Side Screens		12" x 17"	18" x 17"	24" x 17"	—
Base Price		\$171	\$239	\$288	—
Fabric/Vinyl Grade 1	FG1/VG1	+ \$0	+ \$0	+ \$0	—
Fabric/Vinyl Grade 2	FG2/VG2	+ \$7	+ \$7	+ \$13	—
Fabric/Vinyl Grade 3	FG3/VG3	+ \$18	+ \$18	+ \$36	—
Fabric/Vinyl Grade 4	FG4/VG4	+ \$31	+ \$31	+ \$63	—
Fabric/Vinyl Grade 5	FG5/VG5	+ \$54	+ \$54	+ \$107	—
Fabric/Vinyl Grade 6	FG6/VG6	+ \$76	+ \$76	+ \$152	—
Fabric/Vinyl Grade 7	FG7/VG7	+ \$99	+ \$99	+ \$197	—
23" Wide Side Screens		12" x 23"	18" x 23"	24" x 23"	—
Base Price		\$189	\$265	\$319	—
Fabric/Vinyl Grade 1	FG1/VG1	+ \$0	+ \$0	+ \$0	—
Fabric/Vinyl Grade 2	FG2/VG2	+ \$9	+ \$9	+ \$17	—
Fabric/Vinyl Grade 3	FG3/VG3	+ \$23	+ \$23	+ \$46	—
Fabric/Vinyl Grade 4	FG4/VG4	+ \$40	+ \$40	+ \$81	—
Fabric/Vinyl Grade 5	FG5/VG5	+ \$69	+ \$69	+ \$138	—
Fabric/Vinyl Grade 6	FG6/VG6	+ \$98	+ \$98	+ \$196	—
Fabric/Vinyl Grade 7	FG7/VG7	+ \$127	+ \$127	+ \$253	—

EFFECTIVE OCTOBER 17, 2022 | GSA SIN #: 33721

2. Material (Cont.)

Material Grade	Code	12" (H) Price	18" (H) Price	24" (H) Price	30" (H) Price
29" Wide Side Screens		12" x 29"	18" x 29"	24" x 29"	—
Base Price		\$209	\$293	\$354	—
Fabric/Vinyl Grade 1	FG1/VG1	+ \$0	+ \$0	+ \$0	—
Fabric/Vinyl Grade 2	FG2/VG2	+ \$11	+ \$11	+ \$21	—
Fabric/Vinyl Grade 3	FG3/VG3	+ \$28	+ \$28	+ \$57	—
Fabric/Vinyl Grade 4	FG4/VG4	+ \$50	+ \$50	+ \$99	—
Fabric/Vinyl Grade 5	FG5/VG5	+ \$85	+ \$85	+ \$170	—
Fabric/Vinyl Grade 6	FG6/VG6	+ \$121	+ \$121	+ \$241	—
Fabric/Vinyl Grade 7	FG7/VG7	+ \$157	+ \$157	+ \$312	—
24" Wide Screens		—	—	24" x 24"	30" x 24"
Base Price		—	—	\$319	\$405
Fabric/Vinyl Grade 1	FG1/VG1	—	—	+ \$0	+ \$0
Fabric/Vinyl Grade 2	FG2/VG2	—	—	+ \$18	+ \$18
Fabric/Vinyl Grade 3	FG3/VG3	—	—	+ \$48	+ \$48
Fabric/Vinyl Grade 4	FG4/VG4	—	—	+ \$84	+ \$84
Fabric/Vinyl Grade 5	FG5/VG5	—	—	+ \$144	+ \$144
Fabric/Vinyl Grade 6	FG6/VG6	—	—	+ \$204	+ \$204
Fabric/Vinyl Grade 7	FG7/VG7	—	—	+ \$264	+ \$264
30" Wide Screens		—	—	24" x 30"	30" x 30"
Base Price		—	—	\$354	\$447
Fabric/Vinyl Grade 1	FG1/VG1	—	—	+ \$0	+ \$0
Fabric/Vinyl Grade 2	FG2/VG2	—	—	+ \$22	+ \$22
Fabric/Vinyl Grade 3	FG3/VG3	—	—	+ \$58	+ \$58
Fabric/Vinyl Grade 4	FG4/VG4	—	—	+ \$102	+ \$102
Fabric/Vinyl Grade 5	FG5/VG5	—	—	+ \$176	+ \$176
Fabric/Vinyl Grade 6	FG6/VG6	—	—	+ \$249	+ \$249
Fabric/Vinyl Grade 7	FG7/VG7	—	—	+ \$322	+ \$322
36" Wide Screens		12" x 36"	18" x 36"	24" x 36"	30" x 36"
Base Price		\$246	\$344	\$392	\$497
Fabric/Vinyl Grade 1	FG1/VG1	+ \$0	+ \$0	+ \$0	+ \$0
Fabric/Vinyl Grade 2	FG2/VG2	+ \$13	+ \$13	+ \$26	+ \$26
Fabric/Vinyl Grade 3	FG3/VG3	+ \$35	+ \$35	+ \$69	+ \$69
Fabric/Vinyl Grade 4	FG4/VG4	+ \$60	+ \$60	+ \$121	+ \$121
Fabric/Vinyl Grade 5	FG5/VG5	+ \$104	+ \$104	+ \$208	+ \$208
Fabric/Vinyl Grade 6	FG6/VG6	147	147	+ \$295	+ \$295
Fabric/Vinyl Grade 7	FG7/VG7	190	+ \$190	+ \$382	+ \$382

EFFECTIVE OCTOBER 17, 2022 | GSA SIN #: 33721

2. Material (Cont.)

Material Grade	Code	12" (H) Price	18" (H) Price	24" (H) Price	30" (H) Price
42" Wide Screens		12" x 42"	18" x 42"	24" x 42"	30" x 42"
Base Price		\$284	\$395	\$435	\$552
Fabric/Vinyl Grade 1	FG1/VG1	+ \$0	+ \$0	+ \$0	+ \$0
Fabric/Vinyl Grade 2	FG2/VG2	+ \$15	+ \$15	+ \$30	+ \$30
Fabric/Vinyl Grade 3	FG3/VG3	+ \$40	+ \$40	+ \$80	+ \$80
Fabric/Vinyl Grade 4	FG4/VG4	+ \$70	+ \$70	+ \$140	+ \$140
Fabric/Vinyl Grade 5	FG5/VG5	+ \$120	+ \$120	+ \$240	+ \$240
Fabric/Vinyl Grade 6	FG6/VG6	+ \$170	+ \$170	+ \$340	+ \$340
Fabric/Vinyl Grade 7	FG7/VG7	+ \$220	+ \$220	+ \$440	+ \$440
48" Wide Screens		12" x 48"	18" x 48"	24" x 48"	30" x 48"
Base Price		\$320	\$446	\$483	\$610
Fabric/Vinyl Grade 1	FG1/VG1	+ \$0	+ \$0	+ \$0	+ \$0
Fabric/Vinyl Grade 2	FG2/VG2	+ \$17	+ \$17	+ \$34	+ \$34
Fabric/Vinyl Grade 3	FG3/VG3	+ \$45	+ \$45	+ \$90	+ \$90
Fabric/Vinyl Grade 4	FG4/VG4	+ \$79	+ \$79	+ \$158	+ \$158
Fabric/Vinyl Grade 5	FG5/VG5	+ \$136	+ \$136	+ \$272	+ \$272
Fabric/Vinyl Grade 6	FG6/VG6	+ \$193	+ \$193	+ \$385	+ \$385
Fabric/Vinyl Grade 7	FG7/VG7	+ \$250	+ \$250	+ \$498	+ \$498
54" Wide Screens		12" x 54"	18" x 54"	24" x 54"	30" x 54"
Base Price		\$340	\$476	\$535	\$646
Fabric/Vinyl Grade 1	FG1/VG1	+ \$0	+ \$0	+ \$0	+ \$0
Fabric/Vinyl Grade 2	FG2/VG2	+ \$19	+ \$19	+ \$38	+ \$38
Fabric/Vinyl Grade 3	FG3/VG3	+ \$50	+ \$50	+ \$101	+ \$101
Fabric/Vinyl Grade 4	FG4/VG4	+ \$88	+ \$88	+ \$177	+ \$177
Fabric/Vinyl Grade 5	FG5/VG5	+ \$152	+ \$152	+ \$304	+ \$304
Fabric/Vinyl Grade 6	FG6/VG6	215	215	431	431
Fabric/Vinyl Grade 7	FG7/VG7	278	278	558	558
60" Wide Screens		12" x 60"	18" x 60"	24" x 60"	30" x 60"
Base Price		\$359	\$502	\$593	\$717
Fabric/Vinyl Grade 1	FG1/VG1	+ \$0	+ \$0	+ \$0	+ \$0
Fabric/Vinyl Grade 2	FG2/VG2	+ \$21	+ \$21	+ \$42	+ \$42
Fabric/Vinyl Grade 3	FG3/VG3	+ \$56	+ \$56	+ \$112	+ \$112
Fabric/Vinyl Grade 4	FG4/VG4	+ \$98	+ \$98	+ \$196	+ \$196
Fabric/Vinyl Grade 5	FG5/VG5	+ \$168	+ \$168	+ \$336	+ \$336
Fabric/Vinyl Grade 6	FG6/VG6	+ \$238	+ \$238	+ \$476	+ \$476
Fabric/Vinyl Grade 7	FG7/VG7	+ \$308	+ \$308	+ \$616	+ \$616

EFFECTIVE OCTOBER 17, 2022 | GSA SIN #: 33721

2. Material (Cont.)

Material Grade	Code	12" (H) Price	18" (H) Price	24" (H) Price	30" (H) Price
66" Wide Screens		12" x 66"	18" x 66"	24" x 66"	30" x 66"
Base Price		\$381	\$534	\$657	\$738
Fabric/Vinyl Grade 1	FG1/VG1	+ \$0	+ \$0	+ \$0	+ \$0
Fabric/Vinyl Grade 2	FG2/VG2	+ \$23	+ \$23	+ \$46	+ \$46
Fabric/Vinyl Grade 3	FG3/VG3	+ \$61	+ \$61	+ \$122	+ \$122
Fabric/Vinyl Grade 4	FG4/VG4	+ \$107	+ \$107	+ \$214	+ \$214
Fabric/Vinyl Grade 5	FG5/VG5	+ \$184	+ \$184	+ \$368	+ \$368
Fabric/Vinyl Grade 6	FG6/VG6	+ \$261	+ \$261	+ \$521	+ \$521
Fabric/Vinyl Grade 7	FG7/VG7	+ \$338	+ \$338	+ \$674	+ \$674
72" Wide Screens		12" x 72"	18" x 72"	24" x 72"	30" x 72"
Base Price		\$405	\$565	\$731	\$757
Fabric/Vinyl Grade 1	FG1/VG1	+ \$0	+ \$0	+ \$0	+ \$0
Fabric/Vinyl Grade 2	FG2/VG2	+ \$25	+ \$25	+ \$50	+ \$50
Fabric/Vinyl Grade 3	FG3/VG3	+ \$66	+ \$66	+ \$133	+ \$133
Fabric/Vinyl Grade 4	FG4/VG4	+ \$116	+ \$116	+ \$233	+ \$233
Fabric/Vinyl Grade 5	FG5/VG5	+ \$200	+ \$200	+ \$400	+ \$400
Fabric/Vinyl Grade 6	FG6/VG6	+ \$283	+ \$283	+ \$567	+ \$567
Fabric/Vinyl Grade 7	FG7/VG7	+ \$366	+ \$366	+ \$734	+ \$734

Please reference the [Textile Reference Guide](#) for information on approved textiles for Motif products.

3. Size

Screen Size (H x W)	Code	Price
17" Wide Side Screens		
12" x 17"	DS1217	+ \$0
18" x 17"	DS1817	+ \$0
24" x 17"	DS2417	+ \$0
23" Wide Side Screens		
12" x 23"	DS1223	+ \$0
18" x 23"	DS1823	+ \$0
24" x 23"	DS2423	+ \$0
29" Wide Side Screens		
12" x 29"	DS1229	+ \$0
18" x 29"	DS1829	+ \$0
24" x 29"	DS2429	+ \$0
24" Wide Screens		
24" x 24"	DS2424	+ \$0
30" x 24"	DS3024	+ \$0
30" Wide Screens		
24" x 30"	DS2430	+ \$0
30" x 30"	DS3030	+ \$0

3. Size (Cont.)

Screen Size (H x W)	Code	Price
36" Wide Screens		
12" x 36"	DS1236	+ \$0
18" x 36"	DS1836	+ \$0
24" x 36"	DS2436	+ \$0
30" x 36"	DS3036	+ \$0
42" Wide Screens		
12" x 42"	DS1242	+ \$0
18" x 42"	DS1842	+ \$0
24" x 42"	DS2442	+ \$0
30" x 42"	DS3042	+ \$0
48" Wide Screens		
12" x 48"	DS1248	+ \$0
18" x 48"	DS1848	+ \$0
24" x 48"	DS2448	+ \$0
30" x 48"	DS3048	+ \$0
54" Wide Screens		
12" x 54"	DS1254	+ \$0
18" x 54"	DS1854	+ \$0
24" x 54"	DS2454	+ \$0
30" x 54"	DS3054	+ \$0

3. Size (Cont.)

Screen Size (H x W)	Code	Price
60" Wide Screens		
12" x 60"	DS1260	+ \$0
18" x 60"	DS1860	+ \$0
24" x 60"	DS2460	+ \$0
30" x 60"	DS3060	+ \$0
66" Wide Screens		
12" x 66"	DS1266	+ \$0
18" x 66"	DS1866	+ \$0
24" x 66"	DS2466	+ \$0
30" x 66"	DS3066	+ \$0
72" Wide Screens		
12" x 72"	DS1272	+ \$0
18" x 72"	DS1872	+ \$0
24" x 72"	DS2472	+ \$0
30" x 72"	DS3072	+ \$0

4. Mount

Mount Style	Code	Price
Protective/Privacy		
Edge Mount Compatibility: 17"-54" Screen Width 12"-24" Screen Height	MT1	+ \$88
Edge Mount Compatibility: 60"-72" Screen Width 12"-24" Screen Height	MT1	+ \$132
Middle Mount Compatibility: 17"-29" Screen Width 12"-24" Screen Height	MT2	+ \$88
Top Mount Compatibility: 17"-54" Screen Width 12"-24" Screen Height	MT3	+ \$56
Top Mount Compatibility: 60"-72" Screen Width 12"-24" Screen Height	MT3	+ \$84
Freestanding Mount Compatibility: 17"-54" Screen Width 12"-24" Screen Height	MT4	+ \$88
Freestanding Mount Compatibility: 60"-72" Screen Width 12"-24" Screen Height	MT4	+ \$132

FABRIC WORKSURFACE SCREEN

4. Mount (Cont.)

Mount Style	Code	Price
Protective/Privacy (Cont.)		
Small Panel Mount Compatibility: 1.5"-2.3" Panel Depth 17"-54" Screen Width 12"-24" Screen Height	MT9	+ \$88
Small Panel Mount Compatibility: 1.5"-2.3" Panel Depth 60"-72" Screen Width 12"-24" Screen Height	MT9	+ \$132
Large Panel Mount Compatibility: 2.3"-3.7" Panel Depth 17"-54" Screen Width 12"-24" Screen Height	MT10	+ \$88
Large Panel Mount Compatibility: 2.3"-3.7" Panel Depth 60"-72" Screen Width 12"-24" Screen Height	MT10	+ \$132
Protective/Privacy + Modesty		
Height-Adjustable Mount Compatibility: 24"-60" Screen Width 24"-30" Screen Height	MT6	+ \$80
Midway Mount Compatibility: 17"-54" Screen Width 24"-30" Screen Height	MT5	+ \$38
Midway Mount Compatibility: 60"-72" Screen Width 24"-30" Screen Height	MT5	+ \$76

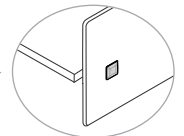
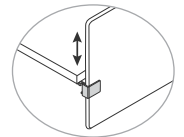
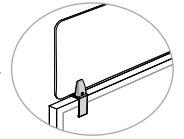

NOTE:

Edge Mounts and Middle Mounts clamp to the work surface and are designed to be used with the standard Exemplis table tops. They will function, as designed, with tops between .9" and 1.5" thick. If the worksurface is less than .9" thick the customer will be responsible to add a spacer to bring the thickness into the allowable range.

Motif

MOBILE + FREESTANDING FABRIC SCREEN

Distance with style.

Now more than ever, our welcoming spaces should be safe—free from contagions, concern and anything that gets in the way of productivity. This collection of mobile and freestanding screens provides the protection and peace of mind you need to work with confidence.



EFFECTIVE OCTOBER 17, 2022

Featured Models

FREESTANDING :: \$1,047

Freestanding screen with glides, 60" x 36", grade 1 fabric, triangular-shaped feet

MOBILE :: \$1,227

Mobile screen with casters, 60" x 36", grade 1 fabric, T-shaped feet

LARGE MOBILE :: \$1,439

Mobile screen with casters, 48" x 72", grade 1 fabric, T-shaped feet

Features

- Mobile and freestanding screens are an easy-to-deploy solution for environments always in motion
- Quick installation creates safer, color-coordinated spaces in minutes
- Durable fabrics designed to heal from pins, thumbtacks and more
- Find privacy + protection with fabrics that are bleach-cleanable, helping protect against COVID-19
- Eco-friendly, single-piece construction features a Hexacore honeycomb center, providing rigidity with less weight
- Compact foot design allows for easy nesting and almost endless storing
- Black, silver or white frame finish
- Foot styles include freestanding with glides or mobile with casters

1. Product

Product Type	Code	Price
Mobile + Freestanding Screens	3092	Priced by Size and Grade

2. Material

Material Type	Code	Price
Fabric/Vinyl	DT701	Priced by Size and Grade

Fabric Grade	Code	Price
30" Wide Screens		53" x 30" 60" x 30" 72" x 30"
Base Price		\$844 \$961 \$1,091
Fabric/Vinyl Grade 1	FG1/VG1	+ \$0 + \$0 + \$0
Fabric/Vinyl Grade 2	FG2/VG2	+ \$48 + \$52 + \$63
Fabric/Vinyl Grade 3	FG3/VG3	+ \$128 + \$140 + \$168
Fabric/Vinyl Grade 4	FG4/VG4	+ \$224 + \$245 + \$294
Fabric/Vinyl Grade 5	FG5/VG5	+ \$384 + \$420 + \$504
Fabric/Vinyl Grade 6	FG6/VG6	+ \$544 + \$595 + \$714
Fabric/Vinyl Grade 7	FG7/VG7	+ \$704 + \$770 + \$924

MOBILE + FREESTANDING SCREEN

2. Material

Fabric Grade	Code	Price
36" Wide Screens		53" x 36" 60" x 36" 72" x 36"
Base Price		\$941 \$1,047 \$1,148
Fabric/Vinyl Grade 1	FG1/VG1	+ \$0 + \$0 + \$0
Fabric/Vinyl Grade 2	FG2/VG2	+ \$48 + \$52 + \$63
Fabric/Vinyl Grade 3	FG3/VG3	+ \$128 + \$140 + \$168
Fabric/Vinyl Grade 4	FG4/VG4	+ \$224 + \$245 + \$294
Fabric/Vinyl Grade 5	FG5/VG5	+ \$384 + \$420 + \$504
Fabric/Vinyl Grade 6	FG6/VG6	+ \$544 + \$595 + \$714
Fabric/Vinyl Grade 7	FG7/VG7	+ \$704 + \$770 + \$924
42" Wide Screens		53" x 42" 60" x 42" 72" x 42"
Base Price		\$1,037 \$1,131 \$1,191
Fabric/Vinyl Grade 1	FG1/VG1	+ \$0 + \$0 + \$0
Fabric/Vinyl Grade 2	FG2/VG2	+ \$48 + \$52 + \$63
Fabric/Vinyl Grade 3	FG3/VG3	+ \$128 + \$140 + \$168
Fabric/Vinyl Grade 4	FG4/VG4	+ \$224 + \$245 + \$294
Fabric/Vinyl Grade 5	FG5/VG5	+ \$384 + \$420 + \$504
Fabric/Vinyl Grade 6	FG6/VG6	+ \$544 + \$595 + \$714
Fabric/Vinyl Grade 7	FG7/VG7	+ \$704 + \$770 + \$924
48" Wide Screens		53" x 48" 60" x 48" 72" x 48"
Base Price		\$1,131 \$1,218 \$1,259
Fabric/Vinyl Grade 1	FG1/VG1	+ \$0 + \$0 + \$0
Fabric/Vinyl Grade 2	FG2/VG2	+ \$48 + \$52 + \$63
Fabric/Vinyl Grade 3	FG3/VG3	+ \$128 + \$140 + \$168
Fabric/Vinyl Grade 4	FG4/VG4	+ \$224 + \$245 + \$294
Fabric/Vinyl Grade 5	FG5/VG5	+ \$384 + \$420 + \$504
Fabric/Vinyl Grade 6	FG6/VG6	+ \$544 + \$595 + \$714
Fabric/Vinyl Grade 7	FG7/VG7	+ \$704 + \$770 + \$924

Please reference the [Textile Reference Guide](#) for information on approved textiles for Motif products.

3. Size

Size (H" x W")	Code	Price
53" x 30"	DS5330	+ \$0
53" x 36"	DS5336	+ \$0
53" x 42"	DS5342	+ \$0
53" x 48"	DS5348	+ \$0
60" x 30"	DS6030	+ \$0
60" x 36"	DS6036	+ \$0
60" x 42"	DS6042	+ \$0
60" x 48"	DS6048	+ \$0
72" x 30"	DS7230	+ \$0
72" x 36"	DS7236	+ \$0
72" x 42"	DS7242	+ \$0
72" x 48"	DS7248	+ \$0

4. Base

Base Design	Code	Price	
T-Shaped Foot	SF4	+ \$0	
Triangular-Shaped Foot	SF5	+ \$0	

Base Finish	Code	Price	
Silver	BF01	+ \$0	
White	BF02	+ \$0	
Black	BF03	+ \$0	

Mobility Options	Code	Price	
Glides	LS18	+ \$0	
Carpet Casters	LS19	+ \$180	

MOBILE + FREESTANDING SCREEN

SPECIFICATIONS

Model:	3092 Motif Mobile/Freestanding Screen
Screen Thickness	1"
Foot Height	0.63" (SF4+LS18), 3.25" (SF5+LS18) 2.75" (SF4+LS19), 5.5" (SF5+LS19)
Foot Length	16.38"
Foot Width	1.5"
Floor to Bottom of Screen	2.63" (LS18) 4.75" (SF4+LS19) 4.88" (SF5+LS19)

Glides (LS18). Casters (LS19). T-shaped foot (SF4). Triangular-shaped foot (SF5).



Motif

MODESTY SCREEN

Versatile peace of mind.

Fashion spaces that are as focused on privacy as they are on design. Our collection of fabric modesty screens come in a variety of color and size options, letting you create environments that are perfectly cohesive and coordinated.



10" x 60" Modesty Screen
Table not included; see [page 423](#) for Parallon Fixed-Top.

EFFECTIVE OCTOBER 17, 2022

Featured Models

48" :: \$415

Modesty Screen, 10" x 48",
grade 1 fabric,

60" :: \$491

Modesty Screen, 10" x 60",
grade 1 fabric,

72" :: \$593

Modesty Screen, 10" x 72",
grade 1 fabric,

Features

- Get customized privacy with durable fabrics designed to heal from pins, thumbtacks and more
- Find privacy + protection with fabrics that are bleach-cleanable, helping protect against COVID-19
- Eco-friendly, single-piece construction features a HexaCore honeycomb center, providing rigidity with less weight
- Width options range from 25" – 72"
- Hinged mount attaches onto edge of bench or table

1. Product

Product Type	Code	Price
Modesty Screen	3093	Priced by Size

2. Product

Material Type	Code	Price
Fabric/Vinyl	DT701	Priced by Grade and Size

Material Grade	Code	Price
Fabric/Vinyl Grade 1	FG1/VG1	Priced by Size
Fabric/Vinyl Grade 2	FG2/VG2	Priced by Size
Fabric/Vinyl Grade 3	FG3/VG3	Priced by Size
Fabric/Vinyl Grade 4	FG4/VG4	Priced by Size
Fabric/Vinyl Grade 5	FG5/VG5	Priced by Size
Fabric/Vinyl Grade 6	FG6/VG6	Priced by Size
Fabric/Vinyl Grade 7	FG7/VG7	Priced by Size

MODESTY SCREEN

3. Size

Screen Size (H x W)	Code	Price	
	10" x 25"		
Base Price	DS1025	\$415	
Fabric/Vinyl Grade 1		+ \$0	
Fabric/Vinyl Grade 2		+ \$17	
Fabric/Vinyl Grade 3		+\$45	
Fabric/Vinyl Grade 4		+\$79	
Fabric/Vinyl Grade 5		+\$136	
Fabric/Vinyl Grade 6		+\$193	
Fabric/Vinyl Grade 7		+\$250	
	10" x 31"		
Base Price	DS1031	\$491	
Fabric/Vinyl Grade 1		+ \$0	
Fabric/Vinyl Grade 2		+\$21	
Fabric/Vinyl Grade 3		+\$56	
Fabric/Vinyl Grade 4		+\$98	
Fabric/Vinyl Grade 5		+\$168	
Fabric/Vinyl Grade 6		+\$238	
Fabric/Vinyl Grade 7		+\$308	
	10" x 36"		
Base Price	DS1036	\$337	
Fabric/Vinyl Grade 1		+ \$0	
Fabric/Vinyl Grade 2		+\$10	
Fabric/Vinyl Grade 3		+\$31	
Fabric/Vinyl Grade 4		+\$55	
Fabric/Vinyl Grade 5		+\$95	
Fabric/Vinyl Grade 6		+\$134	
Fabric/Vinyl Grade 7		+\$173	
	10" x 40"	10" x 42"	
Base Price	DS1040	DS1042	\$374
Fabric/Vinyl Grade 1			+ \$0
Fabric/Vinyl Grade 2			+\$15
Fabric/Vinyl Grade 3			+\$40
Fabric/Vinyl Grade 4			+\$70
Fabric/Vinyl Grade 5			+\$120
Fabric/Vinyl Grade 6			+\$170
Fabric/Vinyl Grade 7			+\$220

3. Size

Screen Size (H x W)	Code		Price
	10" x 46"	10" x 48"	
Base Price	DS1046	DS1048	\$415
Fabric/Vinyl Grade 1			+ \$0
Fabric/Vinyl Grade 2			+\$17
Fabric/Vinyl Grade 3			+\$45
Fabric/Vinyl Grade 4			+\$79
Fabric/Vinyl Grade 5			+\$136
Fabric/Vinyl Grade 6			+\$193
Fabric/Vinyl Grade 7			+\$250
	10" x 52"	10" x 54"	
Base Price	DS1052	DS1054	\$454
Fabric/Vinyl Grade 1			+ \$0
Fabric/Vinyl Grade 2			+\$19
Fabric/Vinyl Grade 3			+\$50
Fabric/Vinyl Grade 4			+\$88
Fabric/Vinyl Grade 5			+\$152
Fabric/Vinyl Grade 6			+\$215
Fabric/Vinyl Grade 7			+\$278
	10" x 58"	10" x 60"	
Base Price	DS1058	DS1060	\$491
Fabric/Vinyl Grade 1			+ \$0
Fabric/Vinyl Grade 2			+\$21
Fabric/Vinyl Grade 3			+\$56
Fabric/Vinyl Grade 4			+\$98
Fabric/Vinyl Grade 5			+\$168
Fabric/Vinyl Grade 6			+\$238
Fabric/Vinyl Grade 7			\$308
	10" x 64"	10" x 66"	
Base Price	DS1064	DS1066	\$531
Fabric/Vinyl Grade 1			+ \$0
Fabric/Vinyl Grade 2			+\$23
Fabric/Vinyl Grade 3			+\$61
Fabric/Vinyl Grade 4			+\$107
Fabric/Vinyl Grade 5			+\$184
Fabric/Vinyl Grade 6			+\$261
Fabric/Vinyl Grade 7			+\$338

MODESTY SCREEN

3. Size

Screen Size (H x W)	Code		Price
	10" x 70"	10" x 72"	
Base Price	DS1070	DS1072	\$593
Fabric/Vinyl Grade 1			+ \$0
Fabric/Vinyl Grade 2			+\$25
Fabric/Vinyl Grade 3			+\$66
Fabric/Vinyl Grade 4			+\$116
Fabric/Vinyl Grade 5			+\$200
Fabric/Vinyl Grade 6			+\$283
Fabric/Vinyl Grade 7			+\$366

4. Mount

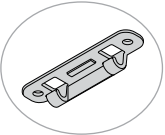
Mount Style	Code	Price	
Modesty Screen Mount Compatibility: 25"-72" Screen Width 10" Screen Height	MT8	+ \$0	

Modesty screens include the cost of the mount.

Sector

ACRYLIC WORKSURFACE SCREEN

Partition and protect.

Now more than ever, our workspaces should be safe—free from distractions, contagions and anything that gets in the way of productivity. This collection of clear and frosted acrylic screens stands ready to provide the privacy, protection and peace of mind you need in a landscape where the way we interact changes every day.



30" x 48" Height-adjustable Frosted Acrylic Screen
Table not included; see page 405 for Switchback 2-Leg.

EFFECTIVE OCTOBER 17, 2022

Featured Models

12" x 23" EDGE :: \$215

12" x 23" frosted acrylic screen,
edge mount

30" x 48" HA :: \$649

30" x 48" frosted acrylic screen,
height-adjustable mount

30" x 60" MIDWAY :: \$787

30" x 60" clear acrylic screen,
midway mount

Features

- Frosted acrylic provides essential privacy while clear acrylic allows for safe social interactions
- High-performing, resilient acrylic surfaces can withstand some of the most powerful cleaners and disinfectants, including a full range of EPA-approved COVID-19 products
- Lightweight material offers greater resistance to impact compared to glass alternatives
- Height options include 12, 18, and 24 inches; 30 inches available for midway and height-adjustable table mounts
- Width options range from 17 to 72 inches (in six-inch increments)
- Compatible with most mounts, including edge, middle, top, midway, freestanding, panel and height-adjustable

1. Product

Product Type	Code	Price
Screen	3090	Priced by Size

2. Material

Material Type	Code	Price
Clear Acrylic	DT101C	Priced by Size
Frosted Acrylic	DT101	Priced by Size





3. Size

Screen Size (H x W)	Code	Price
17" Wide Side Screens		
12" x 17"	DS1217	\$94
18" x 17"	DS1817	\$128
24" x 17"	DS2417	\$168
23" Wide Side Screens		
12" x 23"	DS1223	\$127
18" x 23"	DS1823	\$190
24" x 23"	DS2423	\$226
29" Wide Side Screens		
12" x 29"	DS1229	\$159
18" x 29"	DS1829	\$237
24" x 29"	DS2429	\$287

3. Size (Cont.)

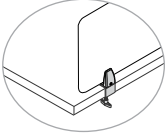
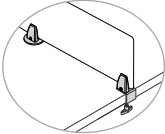
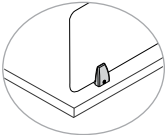
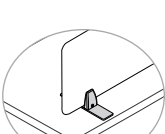
Screen Size (H x W)	Code	Price
24" Wide Screens		
24" x 24"	DS2424	\$226
30" x 24"	DS3024	\$287
30" Wide Screens		
24" x 30"	DS2430	\$287
30" x 30"	DS3030	\$358
36" Wide Screens		
12" x 36"	DS1236	\$195
18" x 36"	DS1836	\$292
24" x 36"	DS2436	\$354
30" x 36"	DS3036	\$427
42" Wide Screens		
12" x 42"	DS1242	\$226
18" x 42"	DS1842	\$341
24" x 42"	DS2442	\$412
30" x 42"	DS3042	\$498
48" Wide Screens		
12" x 48"	DS1248	\$258
18" x 48"	DS1848	\$387
24" x 48"	DS2448	\$456
30" x 48"	DS3048	\$569
54" Wide Screens		
12" x 54"	DS1254	\$292
18" x 54"	DS1854	\$434
24" x 54"	DS2454	\$528
30" x 54"	DS3054	\$640
60" Wide Screens		
12" x 60"	DS1260	\$323
18" x 60"	DS1860	\$483
24" x 60"	DS2460	\$569
30" x 60"	DS3060	\$711
66" Wide Screens		
12" x 66"	DS1266	\$355
18" x 66"	DS1866	\$485
24" x 66"	DS2466	\$625
30" x 66"	DS3066	\$781
72" Wide Screens		
12" x 72"	DS1272	\$387
18" x 72"	DS1872	\$527
24" x 72"	DS2472	\$683
30" x 72"	DS3072	\$851

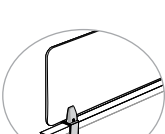
4. Mount

Mount Style	Code	Price	
Protective/Privacy			
Edge Mount Compatibility: 17"-54" Screen Width 12"-24" Screen Height	MT1	+ \$88	
Edge Mount Compatibility: 60"-72" Screen Width 12"-24" Screen Height	MT1	+ \$132	
Middle Mount Compatibility: 17"-29" Screen Width 12"-24" Screen Height	MT2	+ \$88	
Top Mount Compatibility: 17"-54" Screen Width 12"-24" Screen Height	MT3	+ \$56	
Top Mount Compatibility: 60"-72" Screen Width 12"-24" Screen Height	MT3	+ \$84	
Freestanding Mount Compatibility: 17"-54" Screen Width 12"-24" Screen Height	MT4	+ \$88	
Freestanding Mount Compatibility: 60"-72" Screen Width 12"-24" Screen Height	MT4	+ \$132	
Small Panel Mount Compatibility: 1.5"-2.3" Panel Depth 17"-54" Screen Width 12"-24" Screen Height	MT9	+ \$88	
Small Panel Mount Compatibility: 1.5"-2.3" Panel Depth 60"-72" Screen Width 12"-24" Screen Height	MT9	+ \$132	
Large Panel Mount Compatibility: 2.3"-3.7" Panel Depth 17"-54" Screen Width 12"-24" Screen Height	MT10	+ \$88	
Large Panel Mount Compatibility: 2.3"-3.7" Panel Depth 60"-72" Screen Width 12"-24" Screen Height	MT10	+ \$132	

4. Mount (Cont.)

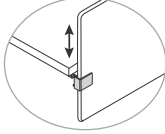
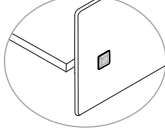
Mount Style	Code	Price	
Protective/Privacy + Modesty			
Height-Adjustable Mount Compatibility: 24"-60" Screen Width 24"-30" Screen Height	MT6	+ \$80	
Midway Mount Compatibility: 17"-54" Screen Width 24"-30" Screen Height	MT5	+ \$38	
Midway Mount Compatibility: 60"-72" Screen Width 24"-30" Screen Height	MT5	+ \$76	

NOTE:

Edge Mounts and Middle Mounts clamp to the work surface and are designed to be used with the standard Exemplis table tops. They will function, as designed, with tops between .9" and 1.5" thick. If the worksurface is less than .9" thick the customer will be responsible to add a spacer to bring the thickness into the allowable range

Sector

MOBILE + FREESTANDING ACRYLIC SCREEN

Adaptable peace of mind.

Now more than ever, our welcoming spaces should be safe—free from contagions, concern and anything that gets in the way of productivity. This collection of mobile and freestanding screens provides the protection and peace of mind you need to work with confidence.



EFFECTIVE OCTOBER 17, 2022

Featured Models

FREESTANDING :: \$1,069

Freestanding screen with glides, 60" x 36", frosted acrylic

MOBILE :: \$1,249

Mobile screen with casters, 60" x 36", clear acrylic

LARGE MOBILE :: \$1,451

Mobile screen with casters, 72" x 48", clear acrylic

Features

- Mobile and freestanding screens are an easy-to-deploy solution for environments always in motion
- Quick installation creates safer spaces in minutes
- High-performing, resilient acrylic can withstand some of the most powerful cleaners and disinfectants, including a full range of EPA-approved COVID-19 products
- Frosted acrylic provides privacy while clear acrylic offers unimpeded protection
- Lightweight material offers greater resistance to impact compared to glass alternatives
- Foot styles include freestanding with glides or mobile with casters
- Silver frame finish

SPECIFICATIONS

	3092 Sector Freestanding/Mobile Screen
Screen Thickness	0.75"
Foot Height	0.63" (LS18), 2.63" (LS19)
Foot Length	16.38"
Foot Width	1"
Floor to Bottom of Screen	2.63" (LS18), 4.63" (LS19)

Glides (LS18). Casters (LS19)

MOBILE + FREESTANDING SCREEN

1. Product

Product Type	Code	Price
Freestanding/Mobile Screen	3092	Priced by Size

2. Material

Material Type	Code	Price
Frosted Acrylic	DT101	Priced by Size
Clear Acrylic	DT101C	Priced by Size

3. Size

Screen Size	Code	Price
53" x 30"	DS5330	\$805
53" x 36"	DS5336	\$879
53" x 42"	DS5342	\$955
53" x 48"	DS5348	\$1,028
60" x 30"	DS6030	\$980
60" x 36"	DS6036	\$1,069
60" x 42"	DS6042	\$1,159
60" x 48"	DS6048	\$1,249
72" x 30"	DS7230	\$1,069
72" x 36"	DS7236	\$1,129
72" x 42"	DS7242	\$1,261
72" x 48"	DS7248	\$1,271

4. Base

Base Finish	Code	Price
Silver	BF01	+ \$0
White	BF02	+ \$0
Black	BF03	+ \$0

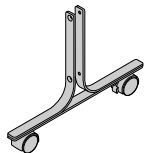

Mobility Options	Code	Price
Glides	LS18	+ \$0
Carpet Casters	LS19	+ \$180

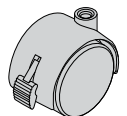
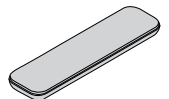

Sector

ACRYLIC SEATING SCREEN

Partition and protect.

Now more than ever, our welcoming spaces should be safe—free from contagions, concern and anything that gets in the way of interacting. This collection of seating screens provides the privacy, protection and peace of mind you need to wait with confidence.



Freelance

EFFECTIVE OCTOBER 17, 2022

Featured Models

AVIERA :: \$542

47" x 24" seating screen compatible with Aviera Guest, Aviera Patient, Aviera Freespan and Aviera Preconfigured models

FOCUS SIDE :: \$542

47" x 24" seating screen compatible with Focus Side chairs. Not compatible with stools or casters

FREELANCE :: \$542



47" x 24" seating screen compatible with Freelance and Freelance Bariatric chair models. Not compatible with stools or casters

Features

- Compatible with Aviera, Freelance and Focus Side
- Seating screens provide fixed, consistent distancing between each chair for safer spaces
- Patent-pending interlocking mount easily transforms current seating configurations while creating more efficient floor plans
- High-performing, resilient acrylic surfaces can withstand some of the most powerful cleaners and disinfectants, including a full range of EPA approved COVID-19 products
- Frosted acrylic provides privacy while clear acrylic allows for safe interactions
- Quick to ship and easy to integrate
- Silver and black bracket finishes

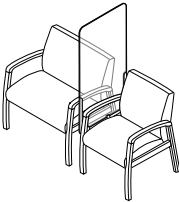

1. Product

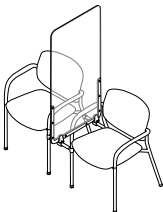
Model	Code	Price	
Screens for Aviera	3097 VRX	\$542	
Screens for Focus Side	3097 56X	\$542	
Screens for Freelance	3097 52X	\$542	

2. Material

Material Type	Code	Price	
Clear Acrylic	DT101C	+ \$0	
Frosted Acrylic	DT101	+ \$0	

Aviera

ACRYLIC SEATING SCREEN

3. Size

Screen Size	Code	Price
47" x 24"	DS4724	+ \$0

4. Finish

Bracket Finish	Code	Price
Black	BKF03	+ \$0
Silver	BKF01	+ \$0

5. Replacements

Parts	Code	Price
Screen	Frame and Screen	\$332
Interlocking Bracket Kit For Focus Side	Complete Bracket	\$210
Interlocking Bracket Kit For Freelance	Complete Bracket	\$210
Interlocking Bracket Kit For Aviera	Complete Bracket	\$210

SPECIFICATIONS

Model:	3097 VRX Seating Screen for Aviera	3097 56X Seating Screen for Focus Side	3097 52X Seating Screen for Freelance
Screen Size	46.5" x 23.5"	46.5" x 23.5"	46.5" x 23.5"
Chair Gap (A) Armless	—	9.5"	10"
Chair Gap (A) With Arms	5.3"	5.7"	6"
From Chair to Screen (B) Armless	—	4.5"	4.75"
From Chair to Screen (B) With Arms	2.4"	2.6"	2.75"
Height to Base of Interlocking Assembly (C)	12.4"	11.3"	11.3"
Height From Floor to Top of Screen (D)	60"	60"	60"
Two Guest Chairs With Screen (E)	54.3"	54.7"	57"
Three Guest Chairs With Screens (F)	84.1"	84.9"	88.5"
Four Guest Chairs With Screens (G)	113.9"	115.1"	120"
Screen Thickness	0.75"	0.75"	0.75"

See the diagram below for assistance with measurements.

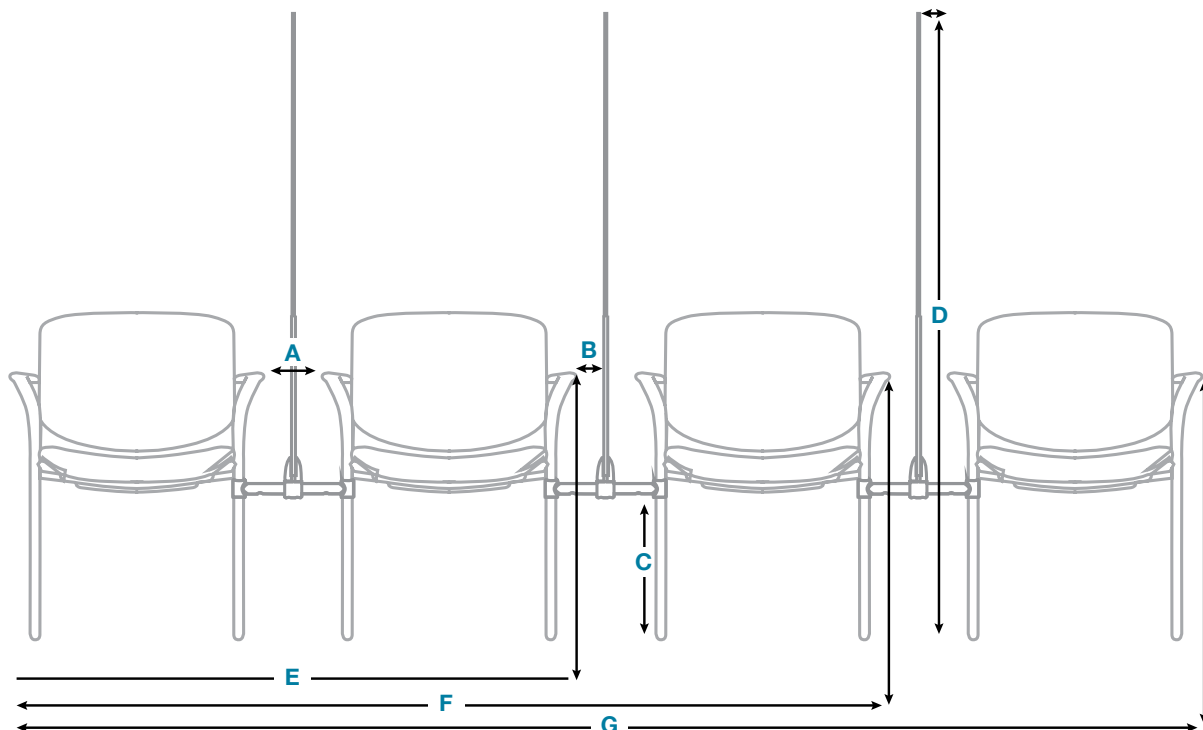

Sector

ACRYLIC CAFÉ SCREEN

Partition and protect.

Partition and protect. Now more than ever, our shared spaces should be safe—free from contagions, concerns and anything that gets in the way of interacting. This collection of acrylic tabletop screens provides the protection and peace of mind you need to socialize with confidence.



EFFECTIVE OCTOBER 17, 2022

Featured Models

2-PERSON :: \$412

2-person screen for 30" round table,
30" screen height

4-PERSON :: \$1,221

4-person screen for 48" square table,
30" screen height

Features

- Clear acrylic allows for safe social interactions
- High-performing, resilient acrylic surfaces can withstand some of the most powerful cleaners and disinfectants, including a full range of EPA-approved COVID-19 products
- Lightweight material offers greater resistance to impact compared to glass alternatives
- 2-Person café table is available with three different foot styles

1. Product

Product Type	Code	Price
Tabletop Screen	3096	Priced by Size

Screen Type	Code	Price
Café Round	CRSC	Priced by Size
Café Square	CSSC	Priced by Size

2. Material

Material Type	Code	Price
Clear Acrylic	DT101C	Priced by Size

3. Size

Screen Height	Code	Price	
Screen Height, 24"	SCH24	Priced by Table Size	
Screen Height, 30"	SCH30	Priced by Table Size	

Table Size	Code	Price	
2-Person Café Screen		24" Height	30" Height
24" Round	TR2424	\$294	\$353
30" Round	TR3030	\$345	\$412
24" Square	TS2424	\$294	\$353
30" Square	TS3030	\$345	\$412
4-Person Café Screen		24" Height	30" Height
36" Round	TR3636	\$486	\$578
42" Round	TR4242	\$537	\$628
48" Round	TR4848	\$584	\$641
36" Square	TS3636	\$828	\$1,100
42" Square	TS4242	\$911	\$1,160
48" Square	TS4848	\$1,001	\$1,221

ACRYLIC CAFÉ SCREEN

4. Feet (2-Person Only)

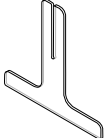
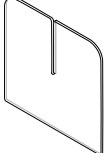
Foot Style	Code	Price	
Round-Shaped	SF1	+ \$0	
T-Shaped	SF2	+ \$0	
Square-Shaped	SF3	+ \$0	

Sector

ACRYLIC TRANSACTION SCREEN

Partition and protect.

Partition and protect. Now more than ever, our shared spaces should be safe—free from contagions, concerns and anything that gets in the way of interacting. This collection of acrylic tabletop screens provides the protection and peace of mind you need to interact with confidence.



EFFECTIVE OCTOBER 17, 2022

Featured Models

PASS-THROUGH :: \$400

24" x 36" acrylic screen, pass-through, round feet

NO PASS-THROUGH :: \$400

24" x 36" acrylic screen, no pass-through, round feet

Features

- 1-on-1 transaction screens sit ready to protect during quick interactions and small get togethers
- Quick and easy tabletop installation means you can provide protection in seconds
- Clear acrylic allows for safe social interactions
- High-performing, resilient acrylic surfaces can withstand some of the most powerful cleaners and disinfectants, including a full range of EPA-approved COVID-19 products.
- Lightweight material offers greater resistance to impact compared to glass alternatives.
- Available with three different foot styles
- Optional 4" tall pass-through

1. Product

Product Type	Code	Price	
Tabletop Screen	3096	Priced by Size	
Screen Type	Code	Price	
Transaction	TRSC	Priced by Size	

2. Material

Material Type	Code	Price	
Clear Acrylic	DT101C	Priced by Size	

3. Size

Size (H x W)	Code	Price	
24" Width			
24" x 24"	SCH24 SCW24	\$294	
30" x 24"	SCH30 SCW24	\$353	
36" x 24"	SCH36 SCW24	\$405	
42" x 24"	SCH42 SCW24	\$433	
30" Width			
24" x 30"	SCH24 SCW30	\$345	
30" x 30"	SCH30 SCW30	\$412	
36" x 30"	SCH36 SCW30	\$442	
42" x 30"	SCH42 SCW30	\$506	

ACRYLIC TRANSACTION SCREEN

3. Size (Cont.)

Size (H x W) (Cont.)	Code	Price	
36" Width			
24" x 36"	SCH24 SCW36	\$400	
30" x 36"	SCH30 SCW36	\$425	
36" x 36"	SCH36 SCW36	\$467	
42" x 36"	SCH42 SCW36	\$545	
48" Width			
24" x 48"	SCH24 SCW48	\$442	
30" x 48"	SCH30 SCW48	\$464	
36" x 48"	SCH36 SCW48	\$486	
42" x 48"	SCH42 SCW48	\$589	

4. Appearance

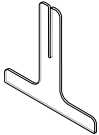
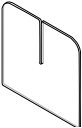
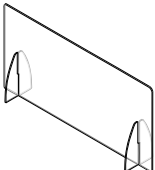
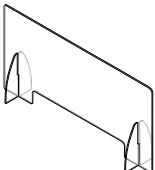
Foot Style	Code	Price	
Round-Shaped	SF1	+ \$0	
T-Shaped	SF2	+ \$0	
Square-Shaped	SF3	+ \$0	
Pass-Through	Code	Price	
No Pass-Through	NPT	+ \$0	
Pass-Through	PTI	+ \$0	

Sector

TRI-FOLD ACRYLIC MEETING AND SINGLE-TABLE SCREEN

Partition and protect.

Partition and protect. Now more than ever, our shared spaces should be safe—free from contagions, concerns and anything that gets in the way of interacting. This collection of acrylic tabletop screens provides the protection and peace of mind you need to meet with confidence.



EFFECTIVE OCTOBER 17, 2022

Featured Models

SINGLE TABLE :: \$604

24" x 48" tri-fold acrylic single-table screen, 24" height

MEETING :: \$1,307

20" x 58" tri-fold acrylic meeting screen, 30" height

Features

- From individual desks to large board rooms, tri-fold meeting screens are personal, mobile and adapt to the busy classroom or office easily
- Single-table tri-fold screens conveniently match common tabletop sizes; tri-fold meeting screens allow you to subdivide larger meeting tables
- High-performing, resilient acrylic surfaces can withstand some of the most powerful cleaners and disinfectants, including a full range of EPA-approved COVID-19 products
- Clear acrylic allows for safe social interactions
- Lightweight material offers greater resistance to impact compared to glass alternatives

1. Product

Product Type	Code	Price
Tabletop Screen	3096	Priced by Size
Product Style	Code	Price

Tri-Fold Screen

TFSC

Priced by Size

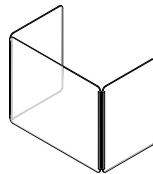

2. Material

Material	Code	Price
Clear Acrylic	DT101C	Priced by Size

TRI-FOLD ACRYLIC MEETING AND SINGLE-TABLE SCREEN

3. Size

Table Size (D x W)	Code	Price
Tri-Fold Single-Table, 24" Height		
18" x 48"	SCH24 SCW46 SCD17	\$482
18" x 60"	SCH24 SCW58 SCD17	\$801
24" x 48"	SCH24 SCW46 SCD23	\$604
24" x 60"	SCH24 SCW58 SCD23	\$923
30" x 48"	SCH24 SCW46 SCD29	\$676
30" x 60"	SCH24 SCW58 SCD29	\$1,016
Tri-Fold Single-Table, 30" Height		
18" x 48"	SCH30 SCW46 SCD17	\$793
18" x 60"	SCH30 SCW58 SCD17	\$1,166
24" x 48"	SCH30 SCW46 SCD23	\$997
24" x 60"	SCH30 SCW58 SCD23	\$1,462
30" x 48"	SCH30 SCW46 SCD29	\$1,019
30" x 60"	SCH30 SCW58 SCD29	\$1,638
Tri-Fold Meeting, 24" Height		
17" x 29"	SCH24 SCW29 SCD17	\$456
17" x 46"	SCH24 SCW46 SCD17	\$482
17" x 58"	SCH24 SCW58 SCD17	\$801
20" x 29"	SCH24 SCW29 SCD20	\$471
20" x 46"	SCH24 SCW46 SCD20	\$541
20" x 58"	SCH24 SCW58 SCD20	\$879
23" x 29"	SCH24 SCW29 SCD23	\$488
23" x 46"	SCH24 SCW46 SCD23	\$604
23" x 58"	SCH24 SCW58 SCD23	\$923
29" x 29"	SCH24 SCW29 SCD29	\$507
Tri-Fold Meeting, 30" Height		
17" x 29"	SCH30 SCW29 SCD17	\$683
17" x 46"	SCH30 SCW46 SCD17	\$793
17" x 58"	SCH30 SCW58 SCD17	\$1,166
20" x 29"	SCH30 SCW29 SCD20	\$763
20" x 46"	SCH30 SCW46 SCD20	\$929
20" x 58"	SCH30 SCW58 SCD20	\$1,307
23" x 29"	SCH30 SCW29 SCD23	\$855
29" x 29"	SCH30 SCW29 SCD29	\$916

On single-table tri-fold screens, the screen depth is 1" less than the table's depth and 2" shorter than the table width.

For instance: A 24" x 48" tabletop has a screen with an actual size of 23" x 46".

EFFECTIVE OCTOBER 17, 2022 | GSA SIN #: 33721

MEETING TABLE COMPATIBILITY CHART

Screen Size (D x W)	Code	Seats Supported
36" x 72" Conference Table		
17" x 29"	SCH24 SCW29 SCD17	2 Seats Per Side
17" x 46"	SCH24 SCW46 SCD17	1 Seat Per Side
17" x 58"	SCH24 SCW58 SCD17	1 Seat Per Side
42" x 84" Conference Table		
20" x 29"	SCH24 SCW29 SCD20	2 Seats Per Side
20" x 46"	SCH24 SCW46 SCD20	1 Seat Per Side
20" x 58"	SCH24 SCW58 SCD20	1 Seat Per Side
48" x 96" Conference Table		
23" x 29"	SCH24 SCW29 SCD23	3 Seats Per Side
23" x 46"	SCH24 SCW46 SCD23	2 Seats Per Side
23" x 58"	SCH24 SCW58 SCD23	1 Seat Per Side
29" x 29"	SCH24 SCW29 SCD29	1 Seat Per Side

Sector

ACRYLIC MODESTY SCREEN



*Frosted Acrylic Modesty Screen
Table not included. See [page 415](#) for Ocala.
Chair not included. See [page 184](#) for Wit.*

EFFECTIVE OCTOBER 17, 2022

Featured Models

48" :: \$355

Modesty Screen, 10" x 48", grade 1 fabric,

60" :: \$420

Modesty Screen, 10" x 60", grade 1 fabric,

72" :: \$507

Modesty Screen, 10" x 72", grade 1 fabric,

Features

- Extra privacy for users
- Hinged mount attaches onto edge of bench or table
- Screens can be built from frosted acrylic or laminate
- Screens are 10" high and available in widths ranging from 25" to 72"
- Acrylic panels are 0.24" thick;

1. Product

Product Type	Code	Price
Modesty Screen	3093	Priced by Size

2. Material

Material Type	Code	Price
Frosted Acrylic	DT101	Priced by Size

3. Size

Screen Size (H x W)	Code	Price
For Rectangular Tables		
10" x 36"	DS1036	\$288
10" x 40"	DS1040	\$288
10" x 42"	DS1042	\$320
10" x 46"	DS1046	\$320
10" x 48"	DS1048	\$355
10" x 52"	DS1052	\$320
10" x 54"	DS1054	\$388
10" x 58"	DS1058	\$420
10" x 60"	DS1060	\$420
10" x 64"	DS1064	\$454
10" x 66"	DS1066	\$454
10" x 70"	DS1070	\$507
10" x 72"	DS1072	\$507
For Trapezoid Tables		
10" x 25"	DS1025	\$355
10" x 31"	DS1031	\$420

4. Mount

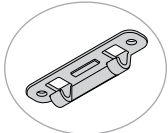
Mount Style	Code	Price	
Modesty Screen Mount Compatibility: 25"-72" Screen Width 10" Screen Height	MT8	+\$0	

Modesty screens include the cost of the mount.

Monitor Arms

SINGLE POLE | DUAL POLE | TRIPLE POLE
SINGLE DESK | DUAL DESK
HEAVY DUTY | DUAL ARRAY

Statement of Line

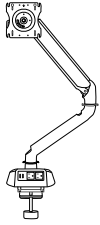

King Cobra

Light Duty Single Screen Arm
3101 MAT01..... [Page 562](#)

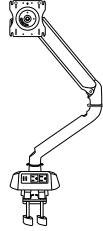

King Cobra

Heavy Duty Single Screen Arm
3101 MAT02..... [Page 562](#)

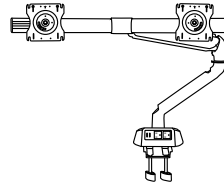

King Cobra

Heavy Duty Dual Array
3101 MAT03..... [Page 562](#)

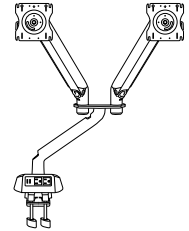

King Cobra

Heavy Duty Dual Screen High-Splitter
3101 MAT04..... [Page 562](#)

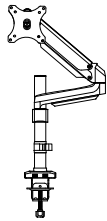

Mobio

Single Pole Monitor Arm
3210 MAT30..... [Page 564](#)

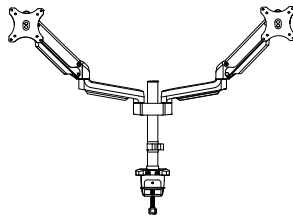

Mobio

Dual Pole Monitor Arm
3210 MAT31..... [Page 564](#)

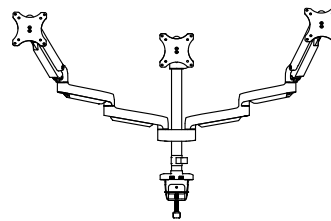

Mobio

Triple Pole Monitor Arm
3210 MAT32..... [Page 564](#)

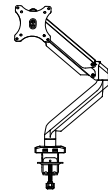

Mobio

Single Desk Monitor Arm
3210 MAT33..... [Page 564](#)

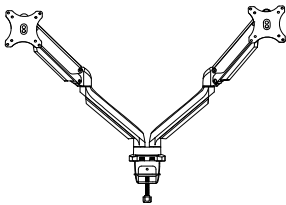

Mobio

Dual Desk Monitor Arm
3210 MAT34..... [Page 564](#)

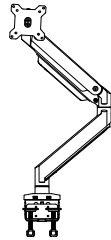

Mobio

Heavy Duty Single Desk Monitor Arm
3210 MAT35..... [Page 564](#)

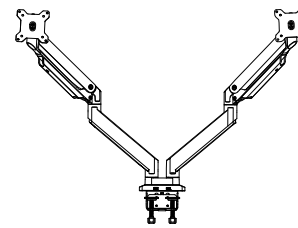

Mobio

Heavy Duty Dual Desk Monitor Arm
3210 MAT36..... [Page 564](#)

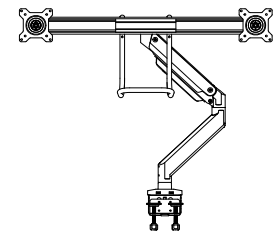

Mobio

Heavy Duty Dual Array Monitor Arm
3210 MAT37..... [Page 564](#)

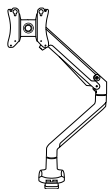

Unity G2

Single
3111 MAT06..... [Page 568](#)

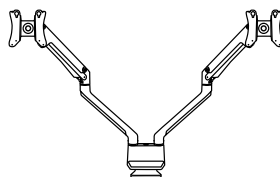

Unity G2

Dual
3111 MAT07..... [Page 568](#)

King Cobra

MONITOR ARM

Charmed by design.

Strike at the heart of productivity with the King Cobra collection of monitor arms. Sleek design, smooth operation, unmatched performance and rugged reliability combine to meet the demands of today's modern office.

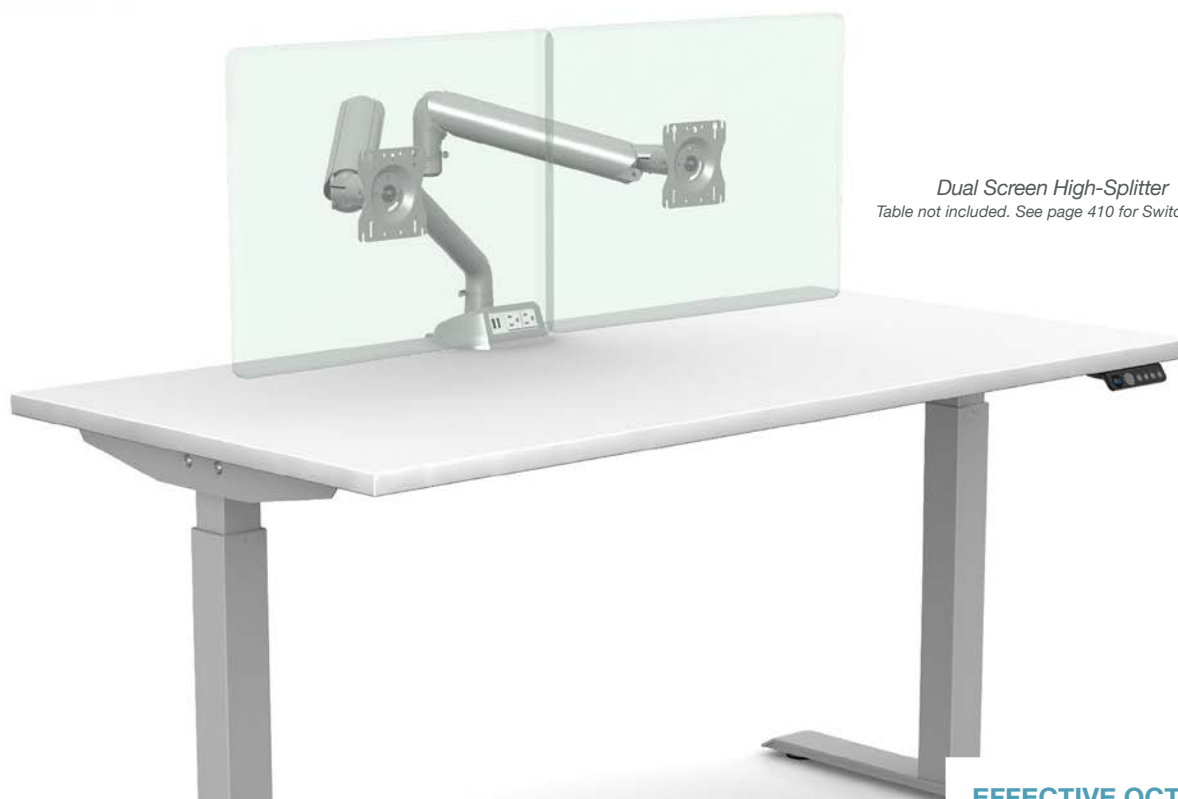

Dual Screen High-Splitter
Table not included. See page 410 for Switchback.

EFFECTIVE OCTOBER 17, 2022

Featured Models

SINGLE SCREEN :: \$729

Light duty single screen monitor arm

DUAL SCREEN HIGH-SPLITTER :: \$1,063

Heavy duty dual screen high-splitter monitor arm

Features

- Die-cast aluminum construction provides greater stability and contains high-recycled material
- A variety of foldable, gas-type arms in light duty, heavy duty and high-splitter configurations
- Portrait and landscape view-adjustable quick-release VESA
- Available in four configurations: Single, HD Single, HD Dual Array and HD Dual High Splitter
- Features two power and two USB outlets
- Adjustable rotation limiter helps restrict arm rotation to 180 degrees
- Includes clamp and grommet mount
- Installs easily with clamp mount and 10-ft power cord

SPECIFICATIONS: SINGLE SCREEN

Model:	MAT01 Light Duty Single Screen	MAT02 Heavy Duty Single Screen
Height	7.63"-22.13"	7.63"-22.13"
Max Arm Extension	24.75"	24.75"
Table Top Thickness	0.39"-1.62"	0.39"-1.62"
VESA	75 mm, 100 mm	75 mm, 100 mm
Power Outlet	120 V	120 V
USB Port	5 V 2.1 Amp	5 V 2.1 Amp
Weight Capacity Warranty	5-20 lb	10-30 lb

SPECIFICATION: DUAL SCREEN

Model:	MAT03 Heavy Duty Dual Array	MAT M04 Heavy Duty Dual Screen High-Splitter
Height	8.43"-22.93"	7.93"-22.43"
Max Arm Extension	29.77"	13.67"
Top Table Thickness	0.39"-1.62"	0.39"-1.62"
VESA	75 mm, 100 mm	75 mm, 100 mm
Power Outlet	120 V	120 V
USB Port	5 V 2.1 Amp	5 V 2.1 Amp
Max Monitor Width	23"	27"
Weight Capacity Warranty (Per Screen)	6-28 lb	10-30 lb

MONITOR ARM

1. Product

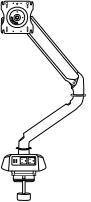
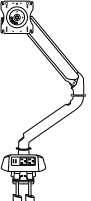
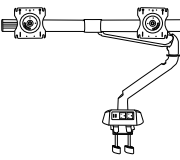
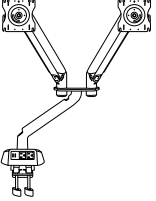
Product Type	Code	Price	
Light Duty Single Screen	3101 MAT01 MAC01	\$729	
Heavy Duty Single Screen	3101 MAT02 MAC01	\$765	
Heavy Duty Dual Array	3101 MAT03 MAC01	\$852	
Heavy Duty Dual Screen High-Splitter	3101 MAT04 MAC01	\$1,063	

2. Slider

Product Type	Code	Price	
Monitor Arm Slider	MAT00	Priced by Style	
Product Style	Code	Price	
Single Slider	MAA01	+ \$157	
Dual Sliders	MAA02	+ \$311	

Mobio

MONITOR ARM

Experience unmatched performance.

When you're hard at work, you need a workspace that works hard for you. With a wide range of motion and ultra-reliability, Mobio is your go-to solution for a family of monitor arms to maximize your space. Its compact design and die cast aluminum construction mean greater stability, flexibility and unmatched performance.



Dual Desk Monitor Arm
Table not included. See [page 417](#) for Switchback.

EFFECTIVE OCTOBER 17, 2022

Featured Models

POWER READY :: \$477

Mobio single desk monitor arm with power block accessory

DUAL DESK :: \$605

Mobio dual desk monitor arm

DUAL ARRAY HD :: \$702

Mobio heavy duty dual array monitor arm

Features

- Choose from Mobio arms in single-desk, dual-desk and pole-mount configurations
- Choose from Mobio HD arms in single-desk, dual-desk and dual-array configurations
- Compact aluminum arm design maximizes desktop space
- Die-cast aluminum construction ensures stability and performance
- Gas spring mechanism delivers smooth vertical adjustment
- Built-in spring tension gauge enables perfect weight adjustment
- Provide power to any worksurface with optional add-on power modules or passthrough USB cables
- Tool-less monitor sliders attach quickly and give an extra dimension of adjustability
- Includes surface clamp and grommet mount, ideal for all desk mounting configurations
- Power-ready and HD dual array models feature 180-degree rotation lock to keep all arms (and elbows) from bumping into walls
- Install monitors easily with quick-release VESA plate
- Mobio arms support monitors 17" to 32" (3.3 lb–17.6 lb); Mobio HD arms support monitors 17"–35" inches (2.2 lb–33 lb)

MONITOR ARM

1. Product

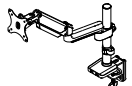
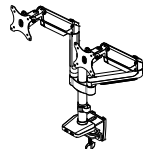
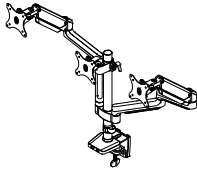
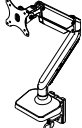
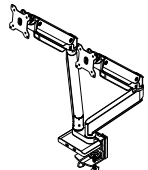
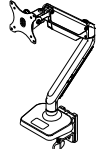
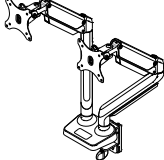
Product Style	Code	Price	
Mobio			
Single Pole Monitor Arm	3210 MAT30	\$387	
Dual Pole Monitor Arm	3210 MAT31	\$696	
Triple Pole Monitor Arm	3210 MAT32	\$807	
Single Desk Monitor Arm	3210 MAT33	\$303	
Dual Desk Monitor Arm	3210 MAT34	\$605	
Single Desk Monitor Arm, Power Ready	3210 MAT38	\$303	
Dual Desk Monitor Arm, Power Ready	3210 MAT39	\$605	

1. Product (Cont.)

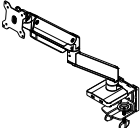
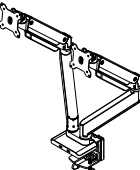
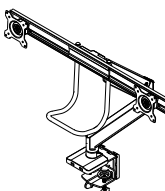

Product Style	Code	Price	
Mobio HD			
Heavy Duty Single Desk Monitor Arm	3210 MAT35	\$473	
Heavy Duty Dual Desk Monitor Arm	3210 MAT36	\$1,060	
Heavy Duty Dual Array Monitor Arm	3210 MAT37	\$702	



Power Ready
Table not included. See [page 439](#) for Switchback.

MONITOR ARM

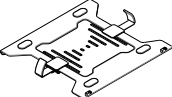
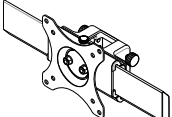
2. Accessories

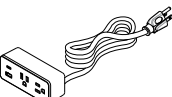
Laptop Support	Code	Price	
No Accessories	MAA00	+ \$0	
Laptop Tray	MAA03	+ \$99	
Monitor Sliders	Code	Price	
Single Slider	MAA01	+ \$120	
Dual Sliders	MAA02	+ \$239	
Power	Code	Price	
Power Block, AC/110V, USB-A, USB-C	MAA03	+ \$174	

Power block (MAA03) is available on independently (MAT00) or on power ready models (MAT38/MAT39) only.

3. Monitor Arm Finish

Paint Color	Code	Price	
Silver	MAC01	+ \$0	
Black	MAC03	+ \$0	

HD models are available in silver (MAC01) finish only.

SPECIFICATIONS: POLE ARMS

	MAT30 Single Pole	MAT31 Dual Pole	MAT32 Triple Pole
Max Monitor Size	17"-32"	17"-32"	17"-27"
Max Arm Extension (A)	23.16"	21.3"	28.58"
1st Arm Segment (B)	3.21"	3.21"	3.21"
2nd Arm Segment (C)	10.83"	10.83"	10.83"
3rd Arm Segment (D)	9.12"	7.27"	7.27"
Height Range (E)	3.54"–22.65"	3.54"–22.64"	6.10"–17.13"
Pole Height (F)	12.58"	12.58"	18.09"
Table Top Thickness	0.39"–2.17"	0.39"–2.17"	0.39"–2.17"
VESA	75 mm 100 mm	75 mm 100 mm	75 mm 100 mm
Weight Capacity (Per Screen)	3.3–17.6 lb	3.3–17.6 lb	3.3–17.6 lb

SPECIFICATIONS: DESK ARMS

	MAT33 Single Desk	MAT34 Dual Desk
Max Monitor Size	17"-32"	17"-32"
Max Arm Extension	20.72"	20.72"
1st Arm Segment (B)	3.21"	3.21"
2nd Arm Segment (C)	10.83"	10.83"
3rd Arm Segment (D)	6.68"	6.68"
Height Range (E)	5.31"–16.24"	5.31"–16.24"
Table Top Thickness	0.39"–2.17"	0.39"–2.17"
VESA	75 mm 100 mm	75 mm 100 mm
Weight Capacity (Per Screen)	3.3–17.6 lb	3.3–17.6 lb

SPECIFICATIONS: HEAVY DUTY ARMS

	MAT35 Single Desk HD	MAT36 Dual Desk	MAT37 Dual Array
Max Monitor Size	17"-35"	17"-35"	17"-32"
Max Extension (A)	23.49"	23.49"	12.68"
1st Arm Segment (B)	2.73"	2.73"	4.09"
2nd Arm Segment (C)	12.62"	12.62"	12.68"
3rd Arm Segment (D)	8.14"	8.14"	8.14"
Height Range	10.03"–23.03"	10.03"–23.03"	10.43"–23.43"
Table Top Thickness	0.39"–2.04"	0.39"–2.04"	0.39"–2.04"
VESA	75 mm 100 mm	75 mm 100 mm	75 mm 100 mm
Weight Capacity (Per Screen)	2.2–33 lb	2.2–33 lb	2.2 lb–17.6 lb

MONITOR ARM

FULLY EXTENDED POLE MODELS

(MAT30 | MAT31 | MAT32)

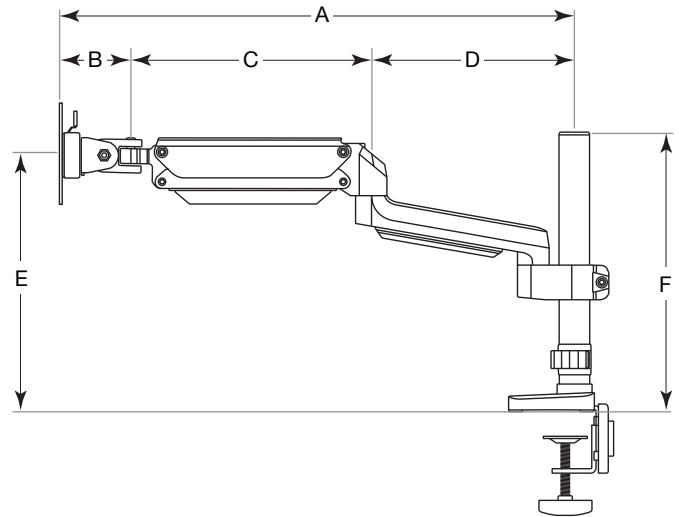

FULLY EXTENDED DESK AND HEAVY DUTY MODELS

(MAT33 | MAT34 | MAT35 | MAT36 | MAT37)

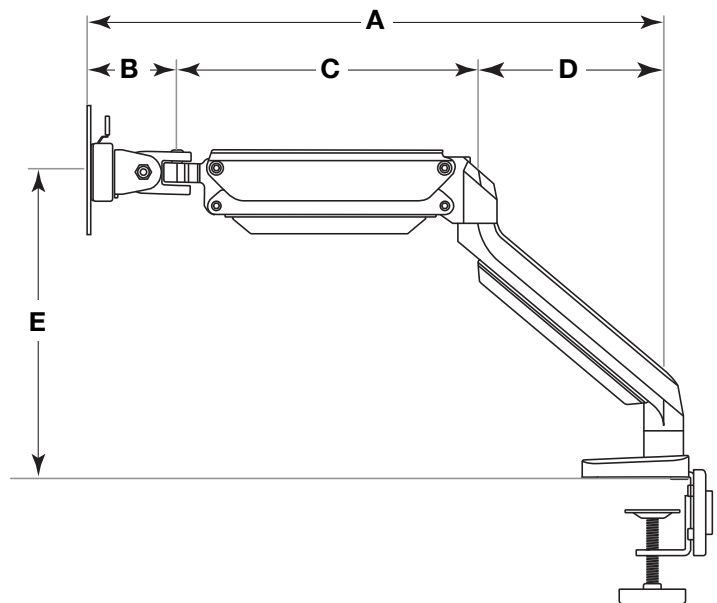

Unity G2

MONITOR ARM

Altogether powerful.

Be one with your work. Our Unity G2 family of monitor arms combine reliable utility with rugged design to create the perfect solution for any workspace.



Single Monitor Arm
Table not included. See page 432 for Tensor.

EFFECTIVE OCTOBER 17, 2022

Featured Models

SINGLE :: \$356

Unity G2 single monitor arm, white finish

DUAL :: \$707

Unity G2 dual monitor arm, silver finish

MONITOR ARM

Features

- Gas height-adjustable
- 12 inches of lift
- 180-degree pan and 360-degree rotation

1. Monitor Arms

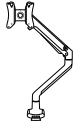
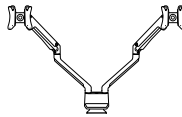
Product Type	Code	Price	
Single	3111 MAT06	\$356	
Dual	3111 MAT07	\$707	

2. Monitor Arm Finish

Paint Color	Code	Price
Silver	MAC01	+ \$0
White	MAC02	+ \$0

SPECIFICATIONS

	3111 MAT06 Single-Monitor	3111 MAT07 Dual-Monitor
Max Screen Size	N/A	17" – 29"
Max Extension	20.92"	20.92"
Height Range	6.9"–18.9"	7.6"–19.4"
VESA	75 mm, 100 mm	75 mm, 100 mm
Table Top Thickness	0.39"–1.5"	0.39"–1.5"
Weight Capacity (Per Arm)	4.4–17.6 lb	4.4–17.6 lb

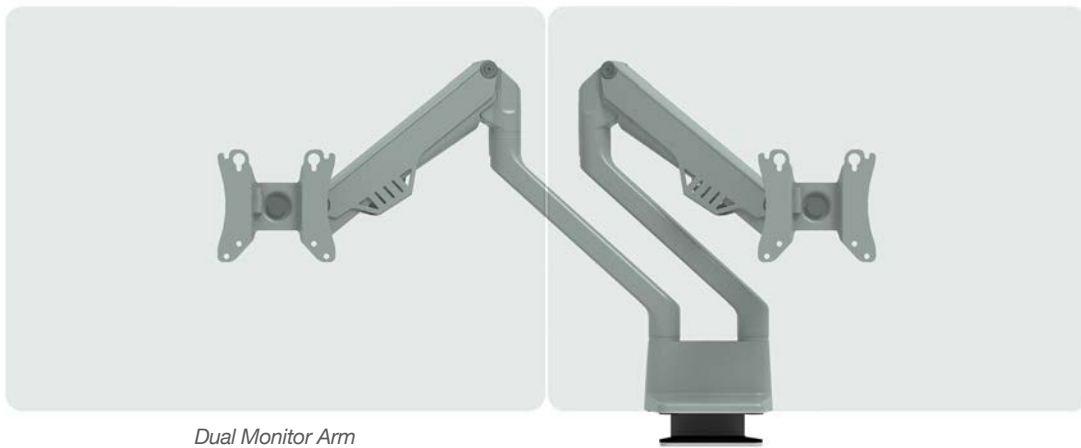

Dual Monitor Arm

Accessories

STORAGE | POWER | LIGHTING
KEYBOARD TRAY | WIRE MANAGEMENT
DESKTOP SIT-TO-STAND
ANTI-FATIGUE MAT

Anti-Fatigue Mat

EFFECTIVE
OCTOBER 17, 2022

Soft and supportive.

Promote well-being while ensuring productivity. Our anti-fatigue mat helps you stand (and work) longer—pairing well with our collections of height-adjustable tables and desktop workstations.

Anti-Fatigue Mat

Product	Code	Price
20" x 30" Black Anti-Fatigue Mat	3153 AFM01	\$214

Features and Specifications

- Provides premium ergonomic comfort
- Can reduce fatigue from standing up to 50%
- Durable single-piece construction
- 100% polyurethane integral skin design
- 20" (D) x 30" (W)
- 5-year warranty



CPU Storage

EFFECTIVE
OCTOBER 17, 2022

Keep it clean.

Secure your PC with ease. Our CPU holder attaches to your workstation for a cleaner look.

CPU Under Desk/Wall Mount



CPU Storage Band



CPU Storage

Product	Code	Price
CPU Storage Band	3156 CPUS1	\$286
CPU Under Desk/Wall Mount	3156 CPUS3	\$144

Features and Specifications

BAND

- Supports most PC sizes (up to 64" in perimeter)
- Retracts on a 17" track with 360-degree swivel
- Quick and easy adjustments with an Allen key
- Weight capacity warranty: Up to 75 lb

UNDER DESK/WALL MOUNT

- Slide-and-swivel movement makes adjustment easy
- Height range: 11.8"-21"
- Depth range: 3.5"-8"
- Track travel: 12.8"

Keyboard Tray

GSA SIN #: 33721
EFFECTIVE
OCTOBER 17, 2022

Lift, tuck and type.

Free up your workspace with our collection of convenient keyboard platforms and platform connectors.

Mini Trackless With Lift and Lock Mechanism



Features and Specifications

LIFT AND LOCK

- Lift and lock provides 7 inches of height adjustment
- Includes knob for manual tilt adjustment
- 21.75" track

PREMIUM LIFT AND LOCK

- Lift and lock height adjustment with automatic tilt adjustment
- Patented height and tilt indicator
- 21.75" track

MINI TRACKLESS

- Designed to attach and function without a track
- Easily attaches below top to avoid crossbar interference

SIT-TO-STAND

- Lift and lock height adjustment with height range from 8" above the track to 6" below
- Control for tilt adjustment
- 23" track

1. Keyboard Tray

Product Type	Code	Price	
Keyboard Tray	3151	\$0	Priced by Style

2. Platform

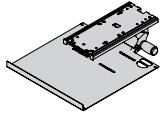
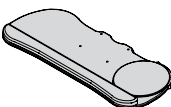
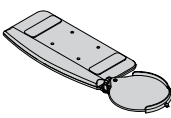
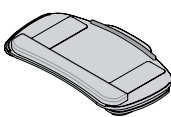
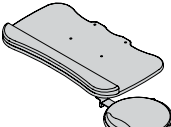
Platform Style	Code	Price	
None	KBP00	+ \$0	
Laptop Tray	KBP01	+ \$157	
Longboard	KBP02	+ \$272	
Mini Platform	KBP03	+ \$327	
Crescent Board	KBP04	+ \$317	
Tilt, Swivel Board	KBP05	+ \$304	

3. Mechanism

Mechanism Style	Code	Price	
None	KBM00	\$0	
HAT	KBM01	\$154	
Lift and Lock	KBM02	\$256	
Mini Trackless	KBM04	\$330	
Premium Lift and Lock	KBM05	\$349	
Sit-to-Stand	KBM06	\$449	

4. Miscellaneous

Options	Code	Price	
None	KBO00	+ \$0	
U-Brackets for Crossrails	KBTA	+ \$114	
Corner Sleeve	KBCS	+ \$202	

Laptop Storage

GSA SIN #: 33721
EFFECTIVE
OCTOBER 17, 2022

Support and store.

Declutter, declutter. If you're tight on space or need to shift gears, our laptop storage is your go-to solution for an extra hand. These add-ons install under your desk and adjusts left to right to fit your work needs.

1. Product

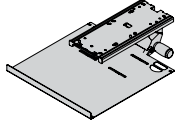
Product Style	Code	Price	
Laptop Tray	3154 LPT02	\$308	



Features and Specifications

- Adjusts left to right to fit in tight places
- Includes mechanism, track and mounting hardware
- Platform: 15" (W) × 15" (L)
- Desk attachment: 5.77" (W) × 12.75" (L)
- Available in black finish only

A bright idea.

Promote bright ideas at every workstation with our value series lighting. It's sleek, simple and turns on with the wave of a hand.



28" Rhythm Lighting

SPECIFICATIONS

Model:	3140 Lighting
Dimensions With Mounts	
Height	1.80"
Length	28.07"
Depth	1.81"
Interconnecting Cable Length	5'
Power Cord Length	6'
Electrical	
Color Temperature	2800 K
LED-Rated Lifespan	50,000 Hours

1. Product

Product Type	Code	Price
Lighting	3140	\$309
Product Style	Code	Price
28" Standard	LSV LFSV	+ \$0
28" Daisy Chain Starter	LSV LFDV	+ \$80

2. Add-On Light Fixtures

Quantity	Code	Price
None	LFAV0	+ \$0
One 28" Daisy Chain	LFAV1	+ \$268
Two 28" Daisy Chain Starters	LFAV2	+ \$533

3. Motion Sensor

Sensor	Code	Price
None	LMS0	+ \$0
Lighting With Motion Sensor	LMS1	+ \$135

Features

- Motion-activated power button
- Built-in 12-hour automatic shut-off feature
- Mounts allow for infinite tilt adjustment for focusing the light
- Dimmer: 3 settings; motion-activated
- Brightness adjustability: 100%–50% in 3 stages
- Color finish: silver aluminum with black end caps
- Housing material: clear anodized aluminum
- Both wood screws and magnet mounts included

Mobile Pedestal

STORAGE SOLUTION

File with flexibility.

Our two-drawer mobile pedestal stores everything you need and can move out of the way while still being within reach.

Mobile Pedestal With Upholstered Pad



EFFECTIVE OCTOBER 17, 2022

Featured Models

NO UPHOLSTERED PAD :: \$364

Mobile pedestal, silver finish, no upholstered pad

WITH UPHOLSTERED PAD :: \$508

Mobile pedestal, white finish, upholstered pad, grade 1 textile

MOBILE PEDESTAL

EFFECTIVE OCTOBER 17, 2022

Features

- Five base wheels provide easy mobility
- Recessed pulls mean flat surfaces for safer work areas
- Optional cushion with colorful upholstery options
- Full extension drawer slides
- Compatible with legal and letter file sizes
- Silver, black and white finish options
- Drawer tested at 50,000 pull cycles

1. Product

Product Type	Code	Price	
Mobile Pedestal	3150	\$364	

Product Style	Code	Price	
---------------	------	-------	--

No Upholstered Pad CPT00 + \$0

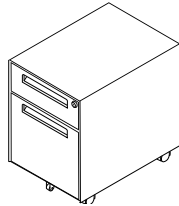

Upholstered Pad CPT01 + \$144

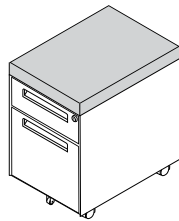

2. Pedestal Finish

Paint Color	Code	Price	
Silver	PDC01	+ \$0	
White	PDC02	+ \$0	
Black	PDC03	+ \$0	

Silver PDC01 + \$0

White PDC02 + \$0

Black PDC03 + \$0

STORAGE SOLUTION

3. Material

Material Grade	Code	Price	
Fabric/Vinyl Grade 1	FG1	+ \$0	
Fabric/Vinyl Grade 2	FG2	+ \$11	
Fabric/Vinyl Grade 3	FG3	+ \$30	
Fabric/Vinyl Grade 4	FG4	+ \$52	
Fabric/Vinyl Grade 5	FG5	+ \$90	
Fabric/Vinyl Grade 6	FG6	+ \$127	
Fabric/Vinyl Grade 7	FG7	+ \$165	

SPECIFICATIONS

	3150 Mobile Pedestal
Height	19.25"
Width	14.25"
Length	19.625"
Cushion Height	1.8"
Drawer Weight Capacity	88 lb
Stationary Weight Capacity (Including Weight of Drawer Contents)	250 lb



Mobile Pedestal With No Upholstered Pad

Pencil Storage

EFFECTIVE
OCTOBER 17, 2022

Store and more.

When it comes to storing pens, pencils and more, our supply drawers are the "write" way to go—keeping everything organized and within reach.



Half Moon Pencil Drawer

1. Product

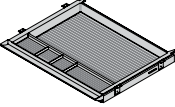
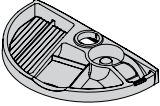
Product Style	Code	Price	
Rectangular Pencil Drawer	3155 PDT01	\$147	
Half Moon Pencil Drawer	3155 PDT02	\$125	

SPECIFICATIONS

Model:	3155 PDT01 Rectangular Pencil Drawer	3155 PDT02 Half Moon Pencil Drawer
Dimensions		
Height	1.94"	1.35"
Width	18.125"	8.23"
Length	22.75"	13.6"
Drawer Extension	11.5"	11.5"

Features

- Divided storage compartments for pens, pencils and other small supplies
- Includes easy-to-follow assembly instructions

Current

POWER

GSA SIN #: 33721
EFFECTIVE
OCTOBER 17, 2022

Plug into productivity.

Our Current power module provides the charge you need to stay on task all day long.



Current Surface Clamp Mount

1. Current Collection

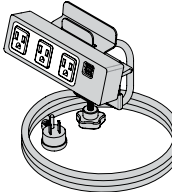
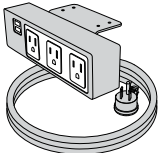
Product Type	Code	Price	
Surface Clamp Mount	3130 PCC	\$278	
Undermount Bracket	3130 PCU	\$319	

2. Color

Module and Cord Color	Code	Price	
White	PC4	+ \$0	
Black	PC1	+ \$0	

Features and Specifications

- Three outlets, 2 USB ports
- White finish features 3.1 amp; black finish comes with 2.1 amp
- Convenient tablet or phone holder built into clamp mount
- 15 amp, 125 volt
- Cord: 10 feet
- Surge protection: 510 joules
- Two USB charging ports; 3.1A combined
- UL/cUL listed (UL962A)

Empower your workspace.

Charge up (to keep up) with your day ahead. EON eliminates the struggle of finding an outlet with an easily accessible power source right at your fingertips. Keep your devices ready for any task with this line of convenient power modules.



Single Outlet, Dual USB

1. EON Collection

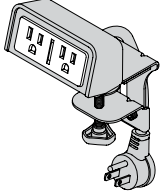
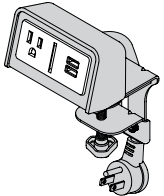
Product Type	Code	Price	
EON Clamp On, Dual Outlet	3130 PTC PT5	\$128	
EON Clamp On, Single Outlet, Dual USB	3130 PTC PT2	\$185	

2. Color

Module and Cord Color	Code	Price	
White	PC4	+ \$0	
Black	PC1	+ \$0	

Features

- Choose from dual-outlet or single-outlet/dual-USB setups
- AC outlet: 15A, 125V, 60Hz
- Quick-charge USB outlets: 3.1A, 5V
- Add an easy-to-access power source at worksurface level
- Installs with surface mount clamp
- Includes 8' power cord that is UL-listed

High Tide

SIT-TO-STAND

EFFECTIVE
OCTOBER 17, 2022

Elevate your task.

Our High Tide offers an easy-to-install solution for converting desktops into an adaptable sit-to-stand, height-adjustable workstation.



High Tide 4

Features

- Infinite height-adjustment increments with lockable gas spring and a height-adjustable range of up to 19.25"
- Desktop size is 17.8" (W) x 32.5" (L);
Keyboard tray size is 6.6" (W) x 32.25" (L);
Overall size is 25.04" (W) x 32.62" (L)
- Desktop supports up to 33 lb;
Keyboard tray supports 4.4 lb
- Single monitor arm weight limit is 20 lb;
Dual monitor arm weight limit is 10 lb per monitor
- Dual monitor arm supports screens up to 22" (W)
- Single monitor arm pole is 12.59" (H);
Dual monitor arm pole is 16.59" (H)
- Desktop material is HDF with CARB certification

1. High Tide

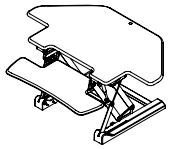
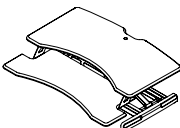
Model	Code	Price	
High Tide Corner Unit	3120 SSHT1	\$679	
High Tide 4	3120 SSHT4	\$573	

2. Monitor Arms

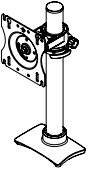
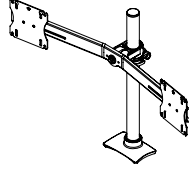
Sit/Stand Monitor Arm	Code	Price	
None	MAT00	+ \$0	
Single Screen	MAT25	+ \$362	
Dual Screen	MAT26	+ \$439	



High Tide Corner Unit

Cable Caddy

WIRE MANAGEMENT

EFFECTIVE
OCTOBER 17, 2022

GSA SIN #: 33721
3152 WM01, 3152 WM03, AND 3152 WM02 ONLY

Clear the cable clutter.

Features

CABLE CADDY

- Fully enclosed design conceals cable clutter
- Sturdy steel construction
- Generous amount of space in caddy opening
- Optional 8-outlet power strip

CABLE CADDY BASKET

- Control cables while maintaining easy access to wires
- Steel wire construction with powdercoated paint
- Black or Silver finish options
- Optional 8-outlet power strip

CABLE CADDY CLIPS

- Includes three wire management pieces
- Place these clips anywhere you need cable control
- Easy installation with four screws



CABLE CADDY SLIM

- Simple cable management solution
- Lightweight polymer construction
- Easily attaches to any smooth surface with included adhesive tape

SPECIFICATIONS

Model:	WM03 Cable Caddy	WM05 Cable Caddy Basket	WM01 Cable Caddy Slim
Dimensions			
Height	6"	6"	1.13"
Length	36"	26"	49"
Depth	4"	6"	2.5"

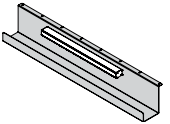
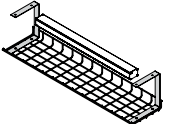
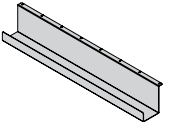
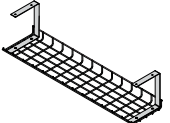
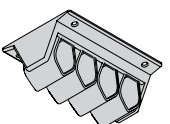
1. Wire Management and Power Strip Add-Ons

Product Type	Code	Price	
Power Strip			
Power Strip	3152 PST1 WM00	\$218	
Wire Management With Power			
Cable Caddy + Power	3152 PST1 WM03	\$396	
Cable Caddy Basket + Power	3152 PST1 WM05	\$316	
Wire Management Without Power			
Cable Caddy	3152 WM03	\$178	
Cable Caddy Basket	3152 WM05	\$98	
Cable Caddy Clips	3152 WM01	\$82	
Cable Caddy Slim	3152 WM02	\$64	

Color	Code	Price	
Black	WMC03	+ \$0	
Silver	WMC01	+ \$0	

Color options available on cable caddy basket (WM05) only.

Appendix

HELPFUL REFERENCE MATERIAL

STAND-ALONE TABLETOPS

GSA SIN #: 33721

1. Table or Desk Top

Product Type	Code	Price
Tabletop or Desktop	3000	Priced by Size

2. Finish

Laminate	Code	Price
Grade 1 Laminate		
Ankara Cherry	TL18	Priced by Size
Black	TL19	Priced by Size
Brazilian Walnut	TL20	Priced by Size
Cabinet Maple	TL21	Priced by Size
Driftwood	TL23	Priced by Size
Folkstone Grey	TL24	Priced by Size
Libretti	TL25	Priced by Size
Queenston Oak	TL26	Priced by Size
Sandalwood	TL27	Priced by Size
Walnut Amati	TL28	Priced by Size
White	TL29	Priced by Size
Grade 2 Laminate		
Classic Linen	TL17	Priced by Size
Colombian Walnut	TL55	Priced by Size
Crisp Linen	TL64	Priced by Size
Designer White	TL66	Priced by Size
Field Elm	TL13	Priced by Size
Frosty White	TL16	Priced by Size
Grey	TL62	Priced by Size
Grey Elm	TL51	Priced by Size
Kingswood Walnut	TL53	Priced by Size
Manitoba	TL56	Priced by Size
Neo Walnut	TL50	Priced by Size
Platinum	TL61	Priced by Size
Portico Teak	TL60	Priced by Size
Skyline Walnut	TL15	Priced by Size
Steel Mesh	TL59	Priced by Size
Tuscan Walnut	TL57	Priced by Size
Uptown Walnut	TL14	Priced by Size
Laminate Grade	Code	Price
Laminate Grade 1	GR1	Priced by Size
Laminate Grade 2	GR2	Priced by Size

3. Shape

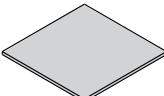
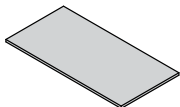
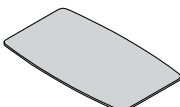
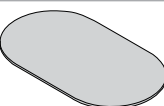
Tabletop Shape	Code	Price	
Café and Occasional			
Round	TR	Priced by Size	
Multipurpose and Training			
Square	TS	Priced by Size	
Meeting			
Rectangular	TZ	Priced by Size	
Wide Boat	TB	Priced by Size	
Wide Racetrack	TK	Priced by Size	

STAND-ALONE TABLETOPS

GSA SIN #: 33721

3. Shape (Cont.)

Tabletop Shape	Code	Price	
For 3-Leg Bases			
Right 90-Degree Tabletop	TBCR	Priced by Size	
Left 90-Degree Tabletop	TBCL	Priced by Size	
120-Degree Top	TA	Priced by Size	
Right Extended Corner	TXR	Priced by Size	
Left Extended Corner	TXL	Priced by Size	
Right Extended Offset Corner	OR	Priced by Size	
Left Extended Offset Corner	OL	Priced by Size	

4. Size

Top Size	Code	Price		
Round (D x W)		Grade 1	Grade 2 Flat Edge	Grade 2 Knife Edge
24"	2424	\$287	\$431	\$494
30"	3030	\$331	\$497	\$536
36"	3636	\$383	\$575	\$622
42"	4242	\$385	\$578	\$694
48"	4848	\$458	\$687	\$825
54"	5454	\$800	\$1,200	\$1,440
60"	6060	\$1,200	\$1,800	\$2,160

Actual size of 30" x 30" tabletop is 30.75" x 30.75"

4. Size (Cont.)

Top Size	Code	Price		
Square (D x W)		Grade 1	Grade 2 Flat Edge	Grade 2 Knife Edge
24"	2424	\$274	\$411	\$494
30"	3030	\$297	\$446	\$536
36"	3636	\$345	\$518	\$622
42"	4242	\$385	\$578	\$694
48"	4848	\$458	\$687	\$825
54"	5454	\$800	\$1,200	\$1,440
60"	6060	\$1,200	\$1,800	\$2,160
Standard Rectangular (D x W)		Grade 1	Grade 2 Flat Edge	Grade 2 Knife Edge
18" x 42"	1842	\$176	\$264	\$317
18" x 48"	1848	\$200	\$300	\$360
18" x 54"	1854	\$225	\$338	\$406
18" x 60"	1860	\$248	\$372	\$447
18" x 66"	1866	\$275	\$413	\$496
18" x 72"	1872	\$300	\$450	\$540
20" x 36"	2036	\$164	\$246	
20" x 42"	2042	\$190	\$285	
20" x 48"	2048	\$218	\$327	
20" x 54"	2054	\$255	\$383	
20" x 60"	2060	\$270	\$405	
20" x 66"	2066	\$299	\$449	
20" x 72"	2072	\$324	\$486	
24" x 36"	2436	\$196	\$294	
24" x 42"	2442	\$229	\$344	\$413
24" x 48"	2448	\$261	\$392	\$471
24" x 54"	2454	\$292	\$438	\$526
24" x 60"	2460	\$324	\$486	\$584
24" x 66"	2466	\$358	\$537	\$645
24" x 72"	2472	\$389	\$584	\$701
24" x 78"	2478	\$421	\$632	
24" x 84"	2484	\$453	\$680	
30" x 36"	3036	\$244	\$366	
30" x 42"	3042	\$285	\$428	\$514
30" x 48"	3048	\$324	\$486	\$584
30" x 54"	3054	\$366	\$549	\$659
30" x 60"	3060	\$404	\$606	\$694
30" x 66"	3066	\$445	\$668	\$802
30" x 72"	3072	\$484	\$726	\$810
30" x 78"	3078	\$526	\$789	
30" x 84"	3084	\$565	\$848	

STAND-ALONE TABLETOPS

4. Size (Cont.)

Top Size	Code	Price		
Standard Rectangular (D x W)		Grade 1	Grade 2 Flat Edge	Grade 2 Knife Edge
36" x 42"	3642	\$540	\$810	\$972
36" x 48"	3648	\$570	\$855	\$1,026
36" x 54"	3654	\$625	\$938	\$1,126
36" x 60"	3660	\$700	\$1,050	\$1,260
36" x 66"	3666	\$790	\$1,185	\$1,422
36" x 72"	3672	\$800	\$1,200	\$1,440
42" x 78"	4278	\$821	\$1,232	
42" x 84"	4284	\$885	\$1,328	
42" x 90"	4290	\$964	\$1,446	
42" x 96"	4296	\$1,008	\$1,512	
48" x 78"	4878	\$939	\$1,409	
48" x 84"	4884	\$1,008	\$1,512	
48" x 90"	4890	\$1,108	\$1,662	
48" x 96"	4896	\$1,152	\$1,728	
Rectangular for Use with eBEAM (D x W)		Grade 1	Grade 2 Flat Edge	Grade 2 Knife Edge
24" x 46"	2446	\$261	\$392	
24" x 58"	2458	\$324	\$486	
24" x 70"	2470	\$389	\$584	
30" x 46"	3046	\$324	\$486	
30" x 58"	3058	\$404	\$606	
30" x 70"	3070	\$484	\$726	
Wide Boat (D x W)		Grade 1	Grade 2 Flat Edge	Grade 2 Knife Edge
42" x 78"	4278	\$821	\$1,232	
42" x 84"	4284	\$885	\$1,328	
42" x 90"	4290	\$964	\$1,446	
42" x 96"	4296	\$1,008	\$1,512	
48" x 78"	4878	\$939	\$1,409	
48" x 84"	4884	\$1,008	\$1,512	
48" x 90"	4890	\$1,108	\$1,662	
48" x 96"	4896	\$1,152	\$1,728	

4. Size (Cont.)

Top Size	Code	Price		
Racetrack (D x W)		Grade 1	Grade 2 Flat Edge	Grade 2 Knife Edge
24" x 60"	2460	\$324	\$486	\$584
30" x 72"	3072	\$450	\$675	\$810
30" x 84"	3084	\$565	\$848	\$1,018
30" x 96"	3096	\$850	\$1,275	\$1,530
36" x 72"	3672	\$800	\$1,200	\$1,440
36" x 84"	3684	\$875	\$1,313	\$1,576
36" x 96"	3696	\$950	\$1,425	\$1,710
42" x 78"	4278	\$821	\$1,232	
42" x 84"	4284	\$885	\$1,328	
42" x 90"	4290	\$964	\$1,446	
42" x 96"	4296	\$1,008	\$1,512	
48" x 78"	4878	\$939	\$1,409	
48" x 84"	4884	\$1,008	\$1,512	
48" x 90"	4890	\$1,108	\$1,662	
48" x 96"	4896	\$1,152	\$1,728	
Right 90-Degree Top (D x W)		Grade 1	Grade 2 Flat Edge	Grade 2 Knife Edge
24" x 48"	2448	\$517	\$776	
24" x 54"	2454	\$582	\$873	
24" x 60"	2460	\$645	\$968	
30" x 48"	3048	\$645	\$968	
30" x 54"	3054	\$729	\$1,094	
30" x 60"	3060	\$805	\$1,208	
Left 90-Degree Top (D x W)		Grade 1	Grade 2 Flat Edge	Grade 2 Knife Edge
24" x 48"	2448	\$517	\$776	
24" x 54"	2454	\$582	\$873	
24" x 60"	2460	\$645	\$968	
30" x 48"	3048	\$645	\$968	
30" x 54"	3054	\$729	\$1,094	
30" x 60"	3060	\$805	\$1,208	
120-Degree Top (D x W)		Grade 1	Grade 2 Flat Edge	Grade 2 Knife Edge
24" x 42"	2442	\$705	\$1,058	
24" x 48"	2448	\$908	\$1,362	
30" x 42"	3042	\$736	\$1,104	
30" x 48"	3048	\$917	\$1,376	

STAND-ALONE TABLETOPS

4. Size (Cont.)

Top Size	Code	Price		
Right Extended Corner (A x B x C)		Grade 1	Grade 2 Flat Edge	Grade 2 Knife Edge
24" x 36" x 60"	243660	\$485	\$728	
24" x 36" x 66"	243666	\$547	\$821	
24" x 36" x 72"	243672	\$618	\$927	
24" x 42" x 60"	244260	\$557	\$836	
24" x 42" x 66"	244266	\$629	\$944	
24" x 42" x 72"	244272	\$710	\$1,065	
24" x 48" x 60"	244860	\$613	\$920	
24" x 48" x 66"	244866	\$692	\$1,038	
24" x 48" x 72"	244872	\$781	\$1,172	
30" x 36" x 60"	303660	\$557	\$836	
30" x 36" x 66"	303666	\$629	\$944	
30" x 36" x 72"	303672	\$760	\$1,140	
30" x 42" x 60"	304260	\$640	\$960	
30" x 42" x 66"	304266	\$723	\$1,085	
30" x 42" x 72"	304272	\$817	\$1,226	
30" x 48" x 60"	304860	\$672	\$1,008	
30" x 48" x 66"	304866	\$760	\$1,140	
30" x 48" x 72"	304872	\$860	\$1,290	
Left Extended Corner (A x B x C)		Grade 1	Grade 2	
24" x 60" x 36"	246036	\$485	\$728	
24" x 66" x 36"	246636	\$547	\$821	
24" x 72" x 36"	247236	\$618	\$927	
24" x 60" x 42"	246042	\$557	\$836	
24" x 66" x 42"	246642	\$629	\$944	
24" x 72" x 42"	247242	\$710	\$1,065	
24" x 60" x 48"	246048	\$613	\$920	
24" x 66" x 48"	246648	\$692	\$1,038	
24" x 72" x 48"	247248	\$781	\$1,172	
30" x 60" x 36"	306036	\$557	\$836	
30" x 66" x 36"	306636	\$629	\$944	
30" x 72" x 36"	307236	\$760	\$1,140	
30" x 60" x 42"	306042	\$640	\$960	
30" x 66" x 42"	306642	\$723	\$1,085	
30" x 72" x 42"	307242	\$817	\$1,226	
30" x 60" x 48"	306048	\$672	\$1,008	
30" x 66" x 48"	306648	\$760	\$1,140	
30" x 72" x 48"	307248	\$860	\$1,290	

4. Size (Cont.)

Top Size	Code	Price		
Right Extended Offset Corner (A x B x C x D)		Grade 1	Grade 2	
24" x 36" x 60" x 30"	24366030	\$531	\$797	
24" x 36" x 66" x 30"	24366630	\$604	\$906	
24" x 36" x 72" x 30"	24367230	\$685	\$1,028	
24" x 42" x 60" x 30"	24426030	\$616	\$924	
24" x 42" x 66" x 30"	24426630	\$697	\$1,046	
24" x 42" x 72" x 30"	24427230	\$793	\$1,190	
24" x 48" x 60" x 30"	24486030	\$648	\$972	
24" x 48" x 66" x 30"	24486630	\$735	\$1,103	
24" x 48" x 72" x 30"	24487230	\$835	\$1,253	
Left Extended Offset Corner (A x B x C x D)		Grade 1	Grade 2	
30" x 60" x 36" x 24"	30603624	\$531	\$797	
30" x 66" x 36" x 24"	30663624	\$604	\$906	
30" x 72" x 36" x 24"	30723624	\$685	\$1,028	
30" x 60" x 42" x 24"	30604224	\$616	\$924	
30" x 66" x 42" x 24"	30664224	\$697	\$1,046	
30" x 72" x 42" x 24"	30724224	\$793	\$1,190	
30" x 60" x 48" x 24"	30604824	\$648	\$972	
30" x 66" x 48" x 24"	30664824	\$735	\$1,103	
30" x 72" x 48" x 24"	30724824	\$835	\$1,253	

5. Grommets

Grommet Location	Code	Price	
No Grommets	GP00	+ \$0	
Left Only	GP01	+ \$30	
Center Only	GP02	+ \$30	
Right Only	GP03	+ \$30	
Left and Center	GP04	+ \$60	
Left and Right	GP05	+ \$60	
Right and Center	GP06	+ \$60	
Left, Right and Center	GP07	+ \$90	
Grommet Color	Code	Price	
Black	GC01	+ \$0	
White	GC02	+ \$0	

Left grommets (GP01/GP04/GP05/GP07) are not available on right extended corners or right extended offset corners.

Right grommets (GP03/GP05/GP06/GP07) are not available on left extended corners or right extended offset corners.

STAND-ALONE TABLETOPS

5. Add-Ons

Mending Plate	Code	Price
None	TTMP0	+ \$0

Mending Plate Kit	TTMP1	+ \$74
-------------------	-------	--------

Stiffener	Code	Price
-----------	------	-------

No Stiffener	STF00	+ \$0
--------------	-------	-------

54" Stiffener (1 Each)	STF01	+ \$80
------------------------	-------	--------

54" Stiffeners (2 Each)	STF02	+ \$160
-------------------------	-------	---------

Mending plate kits are available with tabletops that have a depth of 20", 24" or 30".

Stiffeners are available with and recommended for tabletops that have a depth of 42" or more and/or a width of 66" or more.

Table Weights

Top Size	Grade 1 Laminate	Grade 2 Laminate
----------	------------------	------------------

Round (D x W)

24" x 24"	14 lb	15 lb
30" x 30"	21 lb	23 lb
36" x 36"	31 lb	34 lb
42" x 42"	42 lb	46 lb
48" x 48"	54 lb	60 lb

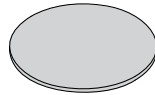

Square (D x W)

24" x 24"	17 lb	19 lb
30" x 30"	27 lb	30 lb
36" x 36"	39 lb	43 lb
42" x 42"	53 lb	58 lb
48" x 48"	69 lb	76 lb

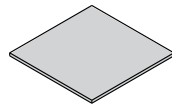

Wide Boat (D x W)

42" x 78"	89 lb	96 lb
42" x 84"	96 lb	104 lb
42" x 90"	103 lb	112 lb
42" x 96"	109 lb	121 lb
48" x 78"	103 lb	107 lb
48" x 84"	111 lb	117 lb
48" x 90"	119 lb	126 lb
48" x 96"	127 lb	136 lb

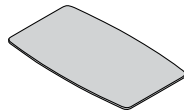
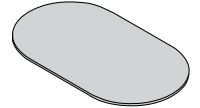

Table Weights (Cont.)

Top Size	Grade 1 Laminate	Grade 2 Laminate
----------	------------------	------------------

Wide Racetrack (D x W)

42" x 78"	87 lb	98 lb
42" x 84"	94 lb	105 lb
42" x 90"	102 lb	113 lb
42" x 96"	110 lb	120 lb
48" x 78"	97 lb	113 lb
48" x 84"	106 lb	122 lb
48" x 90"	115 lb	131 lb
48" x 96"	123 lb	139 lb



Rectangular for Use with eBEAM (-2") (D x W)

24" x 46"	33 lb	36 lb
24" x 58"	42 lb	46 lb
24" x 70"	50 lb	55 lb
30" x 46"	41 lb	46 lb
30" x 58"	52 lb	57 lb
30" x 70"		

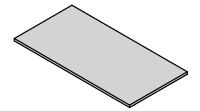

Actual size of 30" x 30" tabletop is 30.75" x 30.75"

STAND-ALONE TABLETOPS

Table Weights (Cont.)

Top Size	Grade 1 Laminate	Grade 2 Laminate
Standard Rectangular (D x W)		
18" x 42"	23 lb	25 lb
18" x 48"	26 lb	29 lb
18" x 54"	29 lb	32 lb
18" x 60"	32 lb	36 lb
18" x 66"	36 lb	39 lb
18" x 72"	39 lb	43 lb
20" x 36"	22 lb	24 lb
20" x 42"	25 lb	28 lb
20" x 48"	29 lb	32 lb
20" x 54"	32 lb	36 lb
20" x 60"	36 lb	40 lb
20" x 66"	40 lb	44 lb
20" x 72"	43 lb	48 lb
24" x 36"	26 lb	29 lb
24" x 42"	30 lb	33 lb
24" x 48"	35 lb	38 lb
24" x 54"	39 lb	43 lb
24" x 60"	43 lb	48 lb
24" x 66"	48 lb	52 lb
24" x 72"	52 lb	57 lb
24" x 78"	56 lb	62 lb
24" x 84"	60 lb	67 lb
30" x 36"	32 lb	36 lb
30" x 42"	38 lb	42 lb
30" x 48"	43 lb	48 lb
30" x 54"	49 lb	53 lb
30" x 60"	54 lb	59 lb
30" x 66"	59 lb	65 lb
30" x 72"	65 lb	71 lb
30" x 78"	70 lb	77 lb
30" x 84"	76 lb	83 lb
42" x 78"	98 lb	108 lb
42" x 84"	106 lb	116 lb
42" x 90"	113 lb	125 lb
42" x 96"	121 lb	133 lb
48" x 78"	112 lb	124 lb
48" x 84"	121 lb	133 lb
48" x 90"	130 lb	143 lb
48" x 96"	138 lb	152 lb

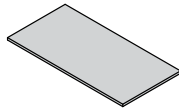
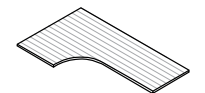
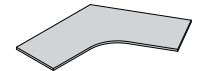
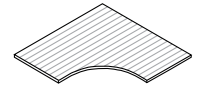
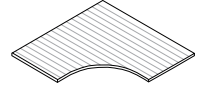

Table Weights (Cont.)

Top Size	Grade 1 Laminate	Grade 2 Laminate
Right 90-Degree Top (D x W)		
24" x 48"	54 lb	59 lb
24" x 54"	63 lb	69 lb
24" x 60"	71 lb	78 lb
30" x 48"	61 lb	68 lb
30" x 54"	72 lb	79 lb
30" x 60"	83 lb	91 lb
Left 90-Degree Top (D x W)		
24" x 48"	54 lb	59 lb
24" x 54"	63 lb	69 lb
24" x 60"	71 lb	78 lb
30" x 48"	61 lb	68 lb
30" x 54"	72 lb	79 lb
30" x 60"	83 lb	91 lb
120-Degree Top (D x W)		
24" x 42"	51 lb	56 lb
24" x 48"	60 lb	66 lb
30" x 42"	61 lb	67 lb
30" x 48"	71 lb	78 lb
Right Extended Corner (A x B x C)		
24" x 36" x 60"	52 lb	58 lb
24" x 36" x 66"	57 lb	62 lb
24" x 36" x 72"	61 lb	67 lb
24" x 42" x 60"	58 lb	63 lb
24" x 42" x 66"	62 lb	68 lb
24" x 42" x 72"	66 lb	73 lb
24" x 48" x 60"	63 lb	69 lb
24" x 48" x 66"	67 lb	74 lb
24" x 48" x 72"	71 lb	78 lb
30" x 36" x 60"	60 lb	66 lb
30" x 36" x 66"	65 lb	71 lb
30" x 36" x 72"	70 lb	77 lb
30" x 42" x 60"	65 lb	72 lb
30" x 42" x 66"	71 lb	78 lb
30" x 42" x 72"	76 lb	84 lb
30" x 48" x 60"	72 lb	79 lb
30" x 48" x 66"	77 lb	85 lb
30" x 48" x 72"	82 lb	91 lb



STAND-ALONE TABLETOPS

Table Weights (Cont.)

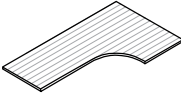
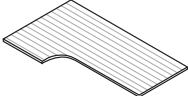
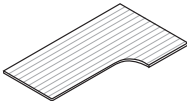
Top Size	Grade 1 Laminate	Grade 2 Laminate	
Left Extended Corner (A x B x C)			
24" x 60" x 36"	52 lb	58 lb	
24" x 66" x 36"	57 lb	62 lb	
24" x 72" x 36"	61 lb	67 lb	
24" x 60" x 42"	58 lb	63 lb	
24" x 66" x 42"	62 lb	68 lb	
24" x 72" x 42"	66 lb	73 lb	
24" x 60" x 48"	63 lb	69 lb	
24" x 66" x 48"	67 lb	74 lb	
24" x 72" x 48"	71 lb	78 lb	
30" x 60" x 36"	60 lb	66 lb	
30" x 66" x 36"	65 lb	71 lb	
30" x 72" x 36"	70 lb	77 lb	
30" x 60" x 42"	65 lb	72 lb	
30" x 66" x 42"	71 lb	78 lb	
30" x 72" x 42"	76 lb	84 lb	
30" x 60" x 48"	72 lb	79 lb	
30" x 66" x 48"	77 lb	85 lb	
30" x 72" x 48"	82 lb	91 lb	
A x B x C x D			
Right Extended Offset Corner			
24" x 36" x 60" x 30"	58 lb	64 lb	
24" x 36" x 66" x 30"	64 lb	70 lb	
24" x 36" x 72" x 30"	69 lb	76 lb	
24" x 42" x 60" x 30"	63 lb	69 lb	
24" x 42" x 66" x 30"	69 lb	75 lb	
24" x 42" x 72" x 30"	74 lb	81 lb	
24" x 48" x 60" x 30"	68 lb	75 lb	
24" x 48" x 66" x 30"	74 lb	81 lb	
24" x 48" x 72" x 30"	79 lb	87 lb	
A x B x C x D			
Left Extended Offset Corner			
30" x 60" x 36" x 24"	58 lb	64 lb	
30" x 66" x 36" x 24"	64 lb	70 lb	
30" x 72" x 36" x 24"	69 lb	76 lb	
30" x 60" x 42" x 24"	63 lb	69 lb	
30" x 66" x 42" x 24"	69 lb	75 lb	
30" x 72" x 42" x 24"	74 lb	81 lb	
30" x 60" x 48" x 24"	68 lb	75 lb	
30" x 66" x 48" x 24"	74 lb	81 lb	
30" x 72" x 48" x 24"	79 lb	87 lb	

SUPER DUTY SERIES GUIDE

Super Duty Series

When it comes to solutions built for uncompromising reliability, durability and comfortability — there's our Super Duty Series. Every side, task and tandem chair in the series features a combination of extra size, width, weight capacity warranty and more.

LIMITED 10-YEAR WARRANTY

SitOnIt Seating warrants the Heavy Duty Series for a period of 10 years when configured to the appropriate model. Fabric and foam cushioning are covered for two years.

TEXTILE DURABILITY

SitOnIt Seating recommends textiles that are high-density and abrasion-resistant, with at least a 75,000 double rub rating.



Heavy Duty

350 LB WEIGHT CAPACITY

- Standard seat and back
- Reinforced seat and heavy duty components
- Task Chairs: Amplify, Focus, Knack, Novo, ReAlign, and TR2
- Task Stools: Non-Stop Heavy Duty Stool and TR2



Large and Tall

400 LB WEIGHT CAPACITY

- Wide seat and standard back
- Thicker and firmer seat
- Reinforced seat and heavy duty components
- Task Chairs: Amplify and Focus



Heavy Duty XL

500 LB WEIGHT CAPACITY

- Widest back and seat
- Thickest and firmest seat and back
- Reinforced seat and back, and heavy duty components
- Task Chair: Non-Stop

SUPER DUTY SERIES GUIDE

Large and Tall Options

SitOnIt Seating Large and Tall (LT) models are available as a standard to provide a fully coordinated and cohesive family offering on our Amplify, Focus and Novo task chairs. Large and Tall accommodates users up to 400 lb and SitOnIt Seating warrants for a period of 10 years used in multi-shift (24/7) applications.

Specify Large and Tall models by using the LT suffix when ordering. Add the appropriate additional charge for each chair. The list below summarizes the model, arm styles, mechanism, frame, back and base options.



Large and Tall (LT) Models

Large and Tall Options (List Price)	Amplify 2723 B1 Y A152 LT	Focus 5623 B1 Y A152 LT	Novo 1033 BK2 Y A152 LT
LT Base Model: Highback, Black Frame, Enhanced Synchro, Height-Adjustable With Sport Arm Pads	\$1,085	\$1,115	\$1,064
1. Arm Styles			
Height-Adjustable With Sport Arm Pads (A152)	+ \$0	+ \$0	+ \$0
Armless (A0)	- \$48	- \$90	- \$48
Height-/Width-Adjustable With Sport Arm Pads (A153)	+ \$30	+ \$25	+\$30
2. Seat Depth			
Seat Depth Adjustment (E3)	+ \$79	+ \$79	+ \$79
3. Frame			
Back Support Color	Black (FC1)	Black (Z1) or Silver (Z2)	Black (FC1)
4. Back			
Upholstered Back (B3/B4)	N/A	+ \$126	N/A
Adjustable Lumbar (LB1)	+ \$0	+ \$50	+ \$0
5. Base			
Polished Aluminum Base (B5)	+ \$167	+ \$167	+ \$167
Heavy Duty Hard Floor and Carpet Casters (C9)	+ \$61	+ \$61	+ \$61
High Heavy Duty Cylinder (S13)	+ \$0	+ \$0	+ \$0

SUPER DUTY SERIES GUIDE

Side Chair Collection



500 LB WEIGHT CAPACITY

Freelance Heavy Duty; Cora Guest, Hip Chair, Counter Stool and Bar Stool.



600 LB WEIGHT CAPACITY

Cora Midsize and Freelance 30" Bariatric



750 LB WEIGHT CAPACITY

Cora Bariatric



1000 LB WEIGHT CAPACITY

Freelance Bariatric 42"

Lounge Collection



500 LB WEIGHT CAPACITY

Aviera Guest Seating, Hip Chair, Patient Seating (21"/24" Seat Width), Freespan 2-seat, Pre-configured 2-seat and 3-seat



750 LB WEIGHT CAPACITY

Aviera Bariatric Seating (30"/44" Seat Width), Freespan 3-Seat

STACKING GUIDE

Discover stacking compatibility with Sitonit Seating's multipurpose products—including a list of SitOnIt models with a wall-saver frame.

4-Leg

Collection	Plastic Seat and Back	Upholstered Seat With Plastic Back	Upholstered Seat and Back	Wall-Saver Frame
On Cart				
Achieve (Glides Only)	—	5	5	•
Anytime (Glides Only)	8	8	8	
Baja (Glides Only)	10	8	8	
Cora Guest (Glides Only)	—	—	6	•
Freelance (Glides Only)	6	6	6	•
InFlex (Glides Only)	12	Arms NR, 10 Armless	Arms NR, 10 Armless	
Lumin (Glides Only)	8	6	6	
Mika (Glides Only)	12	12	—	
Relay (Glides Only)	5	5	5	•
Rio (Glides Only)	8	7	7	
On Floor				
Achieve (Casters and Glides)	—	4	4	•
Anytime (Glides Only)	6	6	6	
Baja (Casters and Glides)	6	4	4	
Cora Guest (Casters and Glides)	—	—	4	•
Freelance (Casters and Glides)	4	4	4	•
InFlex (Casters and Glides)	5	Arms NR, 5 Armless	Arms NR, 5 Armless	
Lumin (Casters and Glides)	6	4	4	
Mika (Casters and Glides)	3	9	—	
Relay (Glides Only)	5	5	5	•
Rio (Casters and Glides)	4	3	3	

4-Leg Mesh

Collection	Plastic Seat Mesh Back	Upholstered Seat With Mesh Back	Fully Upholstered Seat and Back	Wall-Saver Frame
On Cart				
Focus Side (Glides Only)	—	5	3	•
Wit Side (Glides Only)	4	4	4	•
On Floor				
Focus Side (Glides or Casters)	—	4	3	•
Wit Side (Glides or Casters)	4	NR	NR	•

Freelance sled base and bariatric models are not stackable. Relay nester stacks three on the floor; vertical. Ioniq and Qwiz do not stack.

Please note that chairs with a tablet arm do not stack. Chairs with casters do not stack on a cart.

Please use caution when stacking models with casters to prevent frame damage. SitOnIt Seating does not warrant scratched frames.

NR — Not recommended.

STACKING GUIDE

Wire Rod

Collection	Plastic Seat and Back	Upholstered Seat With Plastic Back	Upholstered Seat and Back	Wall-Saver Frame
On Cart				
Baja (Glides Only)	6	4	4	
Lumin (Glides Only)	15	6	6	
Mika	30	12	—	
OnCall (Glides Only)	20 With Arms, 25 Armless	NR	NR	•
Orbix	25	NR	—	
Rio (Glides Only)	15	6	6	
Rowdy (Glides Only)	25 With Arms, 40 Armless	NR	NR	
Sprout	40	—	—	
On Floor				
Baja	6	6	6	
Lumin	8	4	4	
Mika	3	6	—	
OnCall	8	NR	NR	•
Orbix	6	NR	—	
Rio	6	5	5	
Rowdy	10 With Arms, 15 Armless	NR	NR	
Sprout	10	—	—	

Stool

Collection	Plastic Seat and Back	Upholstered Seat With Plastic Back	Upholstered Seat and Back	Wall-Saver Frame
On Floor				
Baja	4	4	4	
Mika	3	3	—	
OnCall	4	NR	NR	•
Orbix	6	NR	—	

Freelance sled base and bariatric models are not stackable. Focus Side wood back models are not stackable. Relay nester stacks three on the floor; vertical. Ioniq and Qwiz do not stack.

Please note that chairs with a tablet arm do not stack. Chairs with casters do not stack on a cart.

Please use caution when stacking models with casters to prevent frame damage. SitOnIt Seating does not warrant scratched frames.

NR — Not recommended.

GLIDE GUIDE

For almost 25 years, SitOnIt Seating products have been expertly designed to provide the best comfort and support in the industry.

Glides are an often overlooked element in the seating specification process, but they play a crucial role in ensuring proper interface between the chair and the floor.

This application guide offers general guidelines to assist customers with choosing the best glide for their needs. The guide is based on extensive lab testing and hands-on experience with selling chairs in a variety of environments, as well as review and consultations with glide experts.

Application Guide

Material

Surfaces

Material		Carpet	VCT	Vinyl	Laminate	Ceramic Tile	Hardwood	Concrete
Standard Multi-Surface Glides		Acceptable	Acceptable	Acceptable	Better	Better	NR	Better
Performance Multi-Surface Glides	Applies to Anytime, Baja, Cora, Freelance, Focus Side, InFlex, Lumin, Rio and Wit Side	Best	Better	Better	Better	Best	Better	Better
Floor Saver Glides		NR	Best	Best	Best	NR	Best	Best
Steel Glides (Carpet Only)		Better	NR	NR	NR	NR	NR	NR

Material

Surfaces

Material		Carpet	VCT	Vinyl	Laminate	Ceramic Tile	Hardwood	Concrete
No Glides	Applies to Baja, Lumin, Mika, OnCall, Orbix, Rio, Rowdy and Sprout	Best	NR	NR	NR	NR	NR	NR
Clear Glides		NR	NR	Acceptable	Better	Better	NR	Acceptable
Clear Glides With Felt		NR	Better	Better	Best	NR	Better	NR

Felt glides are subject to wear and tear and require periodic replacement.

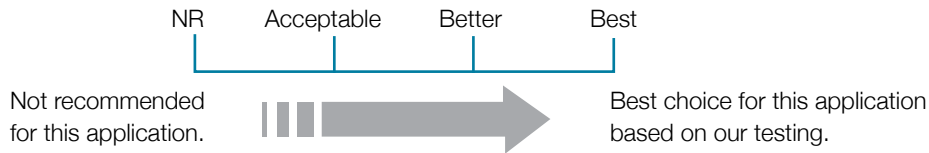

- **BEST:** Best choice for this application based on our testing.
- **BETTER:** Better choice for this application based on our testing.
- **ACCEPTABLE:** Acceptable choice for this application based on our testing but consider BETTER or BEST options.
- **NR:** Not recommended for this application based on our testing.

This Application Guide is provided for informational purposes only. Always follow the manufacturer's instructions for care and maintenance of your flooring. Periodic inspection and maintenance of glides is critical to minimize the risk of damage to your flooring, especially when using glides with floors that are prone to scratching and marring. Testing was performed under simulated conditions. Because a wide range of factors impact actual performance, including how your chairs are used; the state of the glides and flooring; and dirt, moisture and other environmental factors, Exemplis does not warrant you will achieve any specific result. Actual results may vary.

Safety First

To ensure proper cleaning and/or disinfecting, it's important to consult with facilities or safety personnel and follow the manufacturer's instructions—including detailed dilution requirements, safe application instructions, dwell time for effective disinfecting and more.

Per CDC instructions, always read and follow the directions on the label to ensure safe and effective use.

- Wear skin protection and consider eye protection for potential splash hazards
- Ensure adequate ventilation
- Use no more than the amount recommended on the label
- Use water at room temperature for dilution (unless stated otherwise on the label)
- Avoid mixing chemical products
- Label diluted cleaning solutions
- Store and use chemicals out of the reach of children and pets

Always read and follow the directions on the cleaner/disinfectant labels to ensure safe and effective use.

Clean + Disinfect

Cleaning and disinfecting are two distinct actions, and knowing the difference between the two can help promote safety in any space. This comprehensive, 2-step process requires cleaning before disinfecting.

Clean

CLEANING REMOVES GERMS

- The act of removing visible dirt and debris from objects or surfaces
- Cleaning works by using soap/detergent with water to remove impurities from surfaces either manually or mechanically
- Cleaning does not kill germs, but by removing them, it lowers their numbers and risk of spreading infection

Clean (Cont.)

CLEANING GUIDELINES AND TIPS

- Start by lightly dusting with a soft, grit-free cloth or chamois (no wiping)
- After dusting, dampen cloth or chamois with a solution of mild, non-abrasive liquid soap and water
- Wipe clean and dry with a soft, grit-free cloth, sponge or chamois
- Avoid using abrasive cleaners and steel wool to prevent scratching
- Test any cleaning method or agent in an inconspicuous area of the surface

Disinfect

DISINFECTING KILLS GERMS

- This process comes after a surface is cleaned
- Disinfecting kills germs on objects or surfaces with the use of chemicals
- Most common disinfectants include one of the following active ingredients: Quaternary Ammonium (Quats), Sodium Hypochlorite (Bleach), Hydrogen Peroxide, or 70% Isopropyl Alcohol
- EPA-registered disinfectants List N: Disinfectants for Use Against SARS-CoV-2

DISINFECTING GUIDELINES AND TIPS

- Follow the disinfectant manufacturer's instructions when applying the agent
- Once finished, remove all disinfecting agents from the surface with water and a grit-free cloth, then dry
- If not properly removed, disinfectant residue could degrade product life and appearance

Cleaning + Disinfecting efforts should be part of an organization's comprehensive systems-based approach to provide a safe and sustainable workspace.

Cleaning Our Hard Surfaces

Over 95% of the hard surfaces on our products can be cleaned/disinfected using any one of the four primary ingredients listed below.

- Bleach (Sodium Hypochlorite)
- Hydrogen Peroxide
- Quaternary Ammonium Compounds (Quats)
- 70% Isopropyl Alcohol

EXAMPLES OF HARD SURFACES THAT CAN BE DISINFECTED:

- Plastics (i.e. polyurethane and acrylic)
- Solid Surface
- Metals
- Painted Surfaces
- Laminate

EXCEPTIONS:

- Markerboard
- Veneer
- Wood Surfaces

Clean + Disinfect

Cleaning and disinfecting are two distinct actions, and knowing the difference between the two can help promote safety in any space. This comprehensive, 2-step process requires cleaning before disinfecting.

Cleaning Our Soft Surfaces

Our textiles and meshes offer a performance and cleaning story unmatched in the industry.

Our Carded Textile Program offers over 700 bleach-cleanable fabrics through our SitOnIt Seating private label and partnership textile program.

MESH:

- All of our mesh materials are bleach-cleanable. This determination is supported by 3rd-party results from completing AATCC 188 Colorfastness to Bleach testing where the subject material is submersed, and friction stirred in a diluted sodium hypochlorite solution.
- Cleaning of our mesh materials varies. Check out the [Mesh Spec + Care Guide](#) on our website for more information.

SEATING FABRICS:

- Soft surfaces on seating can vary widely from woven, knits and leather to coated textiles such as vinyl and polyurethane. Woven and knits tend to be more permeable than vinyl or polyurethane.
- Cleaning of our seating fabric materials varies. For a list of our textile spec + care guides, see the [Materials Downloads](#) on our website.
- For a list of bleach-cleanable materials, see our [Carded Library](#) and select "Bleach Cleanable" under performance.

SCREEN FABRICS:

- Cleaning of screen materials varies. For a list of our textile spec + care guides, see the [Materials Downloads](#) on our website.
- For a list of bleach-cleanable materials, see our [Carded Library](#) and select "Bleach Cleanable" under performance.

PLASTICS COLOR PROGRAM

From plastic shell colors to mesh colors to custom match colors, SitOnIt Seating gives designers and specifiers lots of options. The table below shows the plastic color options available by collection. All plastic shell colors are available with a 2-day lead time for production.







Plastics

	Anytime	Baja	Freelance	Ioniq	InFlex	Lumin	Mika	OnCall	Orbix	Relay	Qwiz	Rio	Rowdy	Sprout	Wit Side
Apple	—	SC24	—	—	—	SC24	—	—	SC24	—	—	SC24	SC24	—	—
Arctic	—	SC21	SC21	—	SC21	SC21	—	—	SC21	SC21	—	SC21	SC21	SC21	—
Black	SC1	SC1	SC1	SC1	SC1	SC1	SC1	SC1	SC1	SC1	SC1	SC1	SC1	SC1	SC1
Bisque	—	SC7	—	—	—	SC7	—	—	SC7	—	—	SC7	SC7	—	—
Chocolate	—	SC4	SC4	—	SC4	SC4	—	—	SC4	SC4	—	SC4	SC4	SC4	—
Fog	—	—	—	—	—	—	SC27	—	—	—	SC27	—	—	—	—
Lagoon	—	SC15	SC15	—	SC15	SC15	—	—	SC15	SC15	—	SC15	SC15	SC15	—
Latte	—	SC20	SC20	—	SC20	SC20	—	—	SC20	SC20	—	SC20	SC20	SC20	—
Lemon	—	SC25	—	—	—	SC25	—	—	SC25	—	—	SC25	SC25	—	—
Navy	SC5	SC5	SC5	—	SC5	SC5	—	SC5	SC5	SC5	—	SC5	SC5	SC5	SC5
Pacific	—	SC22	—	—	—	SC22	—	—	SC22	—	—	SC22	SC22	—	—
Red	—	SC19	SC19	—	SC19	SC19	—	—	SC19	SC19	—	SC19	SC19	SC19	—
Slate	SC8	SC8	SC8	—	SC8	SC8	—	SC8	SC8	SC8	—	SC8	SC8	SC8	SC8
Sterling	—	SC18	SC18	—	SC18	SC18	—	—	SC18	SC18	—	SC18	SC18	SC18	—
Tangerine	—	SC23	—	—	—	SC23	—	—	SC23	—	—	SC23	SC23	—	—
White	—	—	—	SC26	—	—	SC26	—	—	—	SC26	—	—	—	—

Plastic

Color	Code	
Apple	SC24	
Arctic	SC21	
Black	SC1	
Bisque	SC7	
Chocolate	SC4	
Fog	SC27	

Plastic (Cont.)

Color	Code	
Lagoon	SC15	
Latte	SC20	
Lemon	SC25	
Navy	SC5	
Pacific	SC22	
Red	SC19	

Plastic (Cont.)

Color	Code	
Slate	SC8	
Sterling	SC18	
Tangerine	SC23	
White	SC26	

MESH COLOR PROGRAM











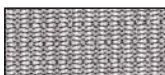

The following collections are available in the mesh color program: Amplify, Focus, Focus 2.0, Focus Side, Mavic, Movi, Novo, Qwiz, Torsa, Vectra, Wit and Wit Side. No minimum orders or additional costs apply.

Mesh



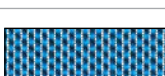







	Amplify	Focus	Focus 2.0	Focus Side	Hexy	Mavic	Movi	Novo	Qwiz	Torsa	Vectra	Wit	Wit Side
Solids													
Apple	MC31	—	MC31	MC31	MC31	MC31	MC31	MC31	MC31	—	—	MC31	MC31
Aqua	MC30	—	—	MC30	—	—	MC30	MC30	MC30	—	—	MC30	MC30
Ash	—	—	MC45	—	—	—	—	—	—	—	—	—	—
Black	—	MC1	MC1	MC1	—	—	—	—	—	—	—	—	—
Charcoal	—	—	MC44	—	—	—	—	—	—	—	—	—	—
Desert	MC9	—	MC9	MC9	MC22	MC9	MC22	MC22	MC22	MC9	MC9	MC22	MC22
Dune	—	—	MC46	—	—	—	—	—	—	—	—	—	—
Electric Blue	MC24	—	MC13	MC24	MC24	MC13	MC24	MC24	MC24	—	—	MC24	MC24
Fire	MC10	—	MC10	MC10	MC25	MC10	MC25	MC25	MC25	MC10	—	MC25	MC25
Fog	MC7	—	MC7	MC7	MC23	MC7	MC23	MC23	MC23	MC7	—	MC23	MC23
Grape	—	—	—	—	—	—	MC26	MC26	MC26	—	—	MC26	MC26
Lemon	—	—	—	—	—	—	MC27	MC27	MC27	—	—	MC27	MC27
Midnight	—	—	MC43	—	—	—	—	—	—	—	—	—	—
Mist	—	—	—	—	—	—	—	—	—	—	MC41	—	—
Navy	MC8	—	MC8	MC8	MC8	MC8	—	—	—	MC8	MC8	—	—
Nickel	MC6	—	MC6	MC6	MC21	MC6	MC21	MC21	MC21	MC6	MC6	MC21	MC21
Ocean	—	—	MC29	—	MC29	MC29	MC29	MC29	MC29	—	—	MC29	MC29
Onyx	MC5	—	MC5	MC5	MC20	MC5	MC20	MC20	MC20	MC5	MC5	MC20	MC20
Platinum	—	—	—	—	—	—	—	—	—	—	MC42	—	—
Slate	—	MC2	MC2	MC2	—	—	—	—	—	—	—	—	—
Sand	—	MC3	MC3	MC3	—	—	—	—	—	—	—	—	—
Tangerine	MC28	—	MC28	MC28	MC28	MC28	MC28	MC28	MC28	—	—	MC28	MC28
Stripes													
Desert Stripe	—	—	—	—	—	—	—	—	—	MC16	—	—	—
Fog Stripe	—	—	—	—	—	—	—	—	—	MC15	—	—	—
Fog Woven Stripe	—	—	—	—	—	—	—	—	—	—	—	MC37	—
Freeway	—	MC33	MC33	MC33	—	—	—	—	—	—	—	—	—
Frost Woven Stripe	—	—	—	—	—	—	—	—	—	—	—	MC36	—
Impress	—	MC34	MC34	MC34	—	—	—	—	—	—	—	—	—
Nickel Woven Stripe	—	—	—	—	—	—	—	—	—	—	—	MC38	—
Onyx Stripe	—	—	—	—	—	—	—	—	—	MC14	—	—	—
Onyx Woven Stripe	—	—	—	—	—	—	—	—	—	—	—	MC35	—

MESH COLOR PROGRAM









Mesh

Mesh Color	Code	
Solids		
Apple	MC31	
Aqua	MC30	
Ash	MC45	
Black	MC1	
Charcoal	MC44	
Desert	MC9/ MC22	
Dune	MC46	
Electric Blue	MC13/ MC24	
Focus 2.0 Electric Blue	MC13	
Fire	MC10/ MC25	
Fog	MC7/ MC23	
Grape	MC26	
Lemon	MC27	

Mesh (Cont.)

Mesh Color	Code	
Solids		
Midnight	MC43	
Mist	MC41	
Navy	MC8	
Nickel	MC6/ MC21	
Ocean	MC5/ MC20	
Onyx	MC20	
Platinum	MC42	
Slate	MC2	
Sand	MC3	
Tangerine	MC28	

Mesh (Cont.)

Mesh Color	Code	
Stripes		
Desert Stripe	MC16	
Fog Stripe	MC15	
Fog Woven Striped	MC37	
Freeway	MC33	
Frost Woven Stripe	MC36	
Impress	MC34	
Onyx Stripe	MC35	
Onyx Woven Striped	MC35	

LAMINATE COLOR PROGRAM

The following collections are available in the laminate color program: Cameo, Nano, Ocala, Parallon, Paséa, Switchback, Tensor and Uni. No minimum orders or additional costs apply.

Laminates

	Aviera	Composium	Envoi	Gobi	Mezzanine	Visit Modular
Grade 1						
Amber Mahogany	FCW3	FCW3				FCW3
Clear Maple	FCW1	FCW1				FCW1
Columbian	—	—				—
Espresso	FCW4	FCW4				FCW4
Medium Cherry	FCW2	FCW2				FCW2
Skyline	—	—				—
Uptown	—	—				—

LAMINATE COLOR PROGRAM

The following collections are available in the laminate color program: Cameo, Nano, Ocala, Parallon, Paséa, Switchback, Tensor and Uni. No minimum orders or additional costs apply.

Laminates











	Cameo	Nano	Ocala	Parallon	Paséa	Switchback	Tensor	Uni
Grade 1								
Ankara Cherry	—	—	TL18	TL18	—	TL18	TL18	—
Black	—	—	TL19	TL19	—	TL19	TL19	—
Brazilian Walnut	—	—	TL20	TL20	—	TL20	TL20	—
Cabinet Maple	—	—	TL21	TL21	—	TL21	TL21	—
Driftwood	—	—	TL23	TL23	—	TL23	TL23	—
Folkstone Grey	—	—	TL24	TL24	—	TL24	TL24	—
Libretti	—	—	TL25	TL25	—	TL25	TL25	—
Queenston Oak	—	—	TL26	TL26	—	TL26	TL26	—
Sandalwood	—	—	TL27	TL27	—	TL27	TL27	—
Walnut Amati	—	—	TL28	TL28	—	TL28	TL28	—
White	—	—	TL29	TL29	—	TL29	TL29	—
Grade 2								
Classic Linen	TL17	TL17	TL17	TL17	TL17	TL17	TL17	—
Colombian Walnut	TL55	—	TL55	TL55	—	TL55	TL55	—
Crisp Linen	TL64	—	TL64	TL64	—	TL64	TL64	—
Designer White	TL66	—	TL66	TL66	—	TL66	TL66	—
Field Elm	TL13	TL13	TL13	TL13	TL13	TL13	TL13	TL13
Frosty White	TL16	TL16	TL16	TL16	TL16	TL16	TL16	TL16
Grey	TL62	—	TL62	TL62	—	TL62	TL62	—
Grey Elm	TL51	—	TL51	TL51	—	TL51	TL51	—
Kingswood Walnut	TL53	—	TL53	TL53	—	TL53	TL53	—
Manitoba	TL56	—	TL56	TL56	—	TL56	TL56	—
Neo Walnut	TL50	—	TL50	TL50	—	TL50	TL50	—
Platinum	TL61	—	TL61	TL61	—	TL61	TL61	—
Portico Teak	TL60	—	TL60	TL60	—	TL60	TL60	—
Skyline Walnut	TL15	TL15	TL15	TL15	TL15	TL15	TL15	TL15
Steel Mesh	TL59	—	TL59	TL59	—	TL59	TL59	—
Tuscan Walnut	TL57	—	TL57	TL57	—	TL57	TL57	—
Uptown Walnut	TL14	TL14	TL14	TL14	TL14	TL14	TL14	TL14

LAMINATE COLOR PROGRAM

Laminate

Color	Code	
Grade 1		
Ankara Cherry	TL18	
Black	TL19	
Brazilian Walnut	TL20	
Cabinet Maple	TL21	
Driftwood	TL23	
Folkstone Grey	TL24	
Libretti	TL25	
Queenston Oak	TL26	
Sandalwood	TL27	
Walnut Amati	TL28	
White	TL29	

Laminate (Cont.)

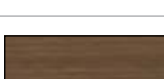
Color	Code	
Grade 2		
Classic Linen	TL17	
Colombian Walnut	TL55	
Crisp Linen	TL64	
Designer White	TL66	
Field Elm	TL13	
Frosty White	TL16	
Grey	TL62	
Grey Elm	TL51	
Kingswood Walnut	TL53	
Manitoba Maple	TL56	
Neo Walnut	MC3	

Laminate (Cont.)

Color	Code	
Grade 2		
Platinum	MC28	
Portico Teak	MC16	
Skyline Walnut	MC15	
Tuscan Walnut	MC37	
Uptown Walnut	MC33	

ARM ADJUSTMENT GUIDE

SitOnIt Seating offers a wide variety of arm styles and adjustments to accommodate all types of users doing a wide variety of tasks. The general adjustments for each arm type are described below. See the website or the product hang tag for specifics.

Armless

Any discussion of arm styles must begin with armless. Armless chairs and stools are less expensive and are easier to get in and out of. However, they do not provide ergonomic support for long-term sitting and task functions.

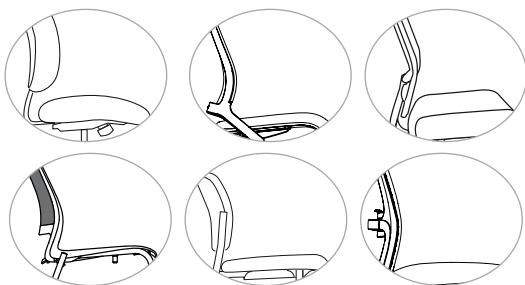

Most chairs and stools are available armless, but the selection may be limited to specific models. For instance, Freelance multipurpose chairs and stools can be specified armless, but not Freelance bariatric chairs.

Fixed

As the name implies, fixed arms cannot be adjusted. Also known as loop arms, cantilever arms and other names, these arms are commonly found on side and multi-seating as well as basic task seating.



Height-Adjustable

This is the most basic adjustable arm. The arm adjusts up or down. Height-adjustable arms are best for basic task work.

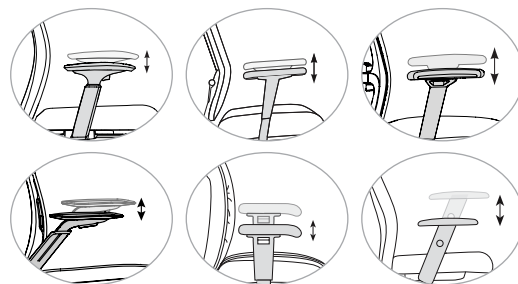

INSTRUCTIONS:

Glove Active, Knack, Non-Stop Heavy Duty, ReAlign, TR2 and Vectra

- To increase or decrease the arm height, press the button and pull up or push down on the arm.

Amplify, Focus, Focus 2.0, Vectra and Wit

- To increase arm height, press the button located under the front of the arm pad and pull the arm up.
- To decrease arm height, press the button located under the front of the arm pad and push the arm down.

Height-adjustable arms are available for Amplify, Focus, Focus 2.0, Glove Active, Knack, Non-Stop Heavy Duty, Novo, ReAlign, TR2, Vectra and Wit.

ARM ADJUSTMENT GUIDE

Height-/Width-Adjustable | Multi-Adjustable

Height-/width-adjustable arms are sometimes called multi-adjustable arms on certain products. The arm adjusts up and down and side to side. This provides more “elbow room” for larger people. Best for basic task work.

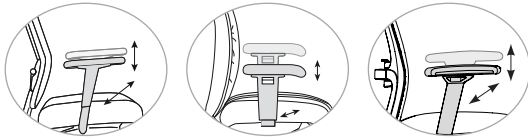

INSTRUCTIONS:

- Height: See instructions in the height-adjustable section.
- Width: To adjust the arm width, push down the lever located under the seat to unlock the width adjustment. Move the arm to the desired width and pull up the lever to lock the arm in place.

Height-/width-adjustable arms are available for Focus, Glove Active, Knack, Non-Stop Heavy Duty, ReAlign and TR2.

Multi-adjustable arms are available for Amplify, Focus 2.0, Novo, Torsa and Vectra.

Height-Adjustable With Pivot

The arm adjusts up and down and 30-degrees in or out. The arms can be turned in to facilitate writing or keyboarding and turned out for other tasks.

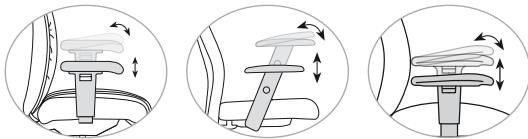

INSTRUCTIONS:

- Height: To increase or decrease the arm height, press the button.
- Pivot: The armrest has three positions: 30-degrees in, center or 30-degrees out. To pivot the arm, grasp the arm pad and move it to one of the three positions.

Height-adjustable arms with pivot are available for Glove Active, ReAlign and TR2.

Height-/Width-Adjustable With Pivot | Multi-Adjustable (Height/Width) With Pivot

This arm adjusts up and down, side to side and 30° in or out.

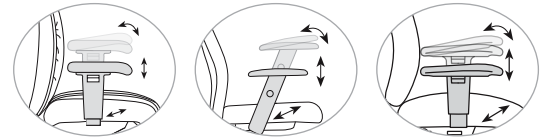

INSTRUCTIONS:

- Height: The arm adjusts up or down. To increase or decrease the arm height, press the button.
- Width: The arm adjusts side to side. To adjust the arm width, push down the lever located under the seat to unlock the width adjustment. Move the arm to the desired width and pull up on the lever to lock the arm in place.
- Pivot: The armrest has three positions: 30° in, center or 30° out (Non-Stop Heavy Duty pivots 15-degrees). To pivot the arm, grasp the arm pad and move it to one of the three positions.

Height-/width-adjustable arms with pivot are available for Glove Active, Non-Stop Heavy Duty, ReAlign and TR2.

Height-Adjustable Break-Away

The arm adjusts up or down and folds down 90-degrees. The folding arm allows for fast and easy ingress and egress and is also great for users with large key rings, tool belts or other personal gear.



INSTRUCTIONS:

- Height: The arm adjusts up or down. To increase or decrease the arm height, press the button.
- Break-Away: To fold the arm back, push down the lever located under the seat to unlock the arm and move the arm back. To return the arm to the original position, pull the arm up until it locks into place.

Height-adjustable break-away arms are available for Non-Stop Heavy Duty (stool only).

ARM ADJUSTMENT GUIDE

Multi-Adjustable (Height/Width) Articulating

The articulating arm adjusts up and down and side to side while the arm pad pivots left and right.

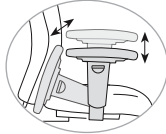

Non-Stop Heavy Duty offers a multi-adjustable articulating arm option.

Fully Adjustable (6-Way)

The six fully adjustable arm adjustments are arm height (up/down), arm pad depth (forward/back) and arm pad side to side (in/out). This ergonomic arm is good for users engaged in a variety of task applications.

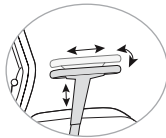

INSTRUCTIONS:

- Height: The arm adjusts up or down. To increase or decrease the arm height, press the button.
- Arm pad depth: The arm pad slides forward or back.
- Width: The arm adjusts side to side.

Fully adjustable (6-way) arms with arm pad depth adjustment are available exclusively on Focus.

Fully Adjustable (6-Way) With Pivot

The six fully adjustable arm adjustments are arm height (up/down), arm pad depth (forward/back) and pivot. This ergonomic arm is good for users engaged in a variety of task applications.

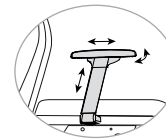

INSTRUCTIONS:

- Height: The arm adjusts up or down. To increase or decrease the arm height, press the button.
- Arm pad depth: The arm pad slides forward or back.
- Pivot: The armrest has three positions: 25° in, center, or 25° out.

Fully adjustable (6-way) arms with pivot are available on Sona and Prava.

Fully Adjustable (8-Way)

The 8-way fully adjustable arms go up/down for height adjustment while the arm pads go forward/back, in/out and pivot in/out for robust support. This all-encompassing arm style makes a perfect fit for today's workplace where broader work applications such as use of smartphones, tablets and other tech accessories are becoming the norm (and require complete forearm support). Pivoting of the arm pads also means that even the most petite of users can adjust accordingly for a more suitable fit.

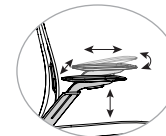

INSTRUCTIONS:

- Height: The arm adjusts up or down. To increase or decrease the arm height, press the button.
- Arm pad depth: The arm pad slides forward or backward.
- Arm pad lateral: The arm pad moves in and out. Not to be confused with the arm width adjustment where the entire arm moves.
- Arm pad pivot: The arm pad pivots in and out to accommodate various work application postures.

Fully adjustable (8-way) arms are available on Focus 2.0 and Vectra.

ARM ADJUSTMENT GUIDE

Fully Multi-Adjustable (10-Way)

The 10-way arm adjustments are arm height, arm width, arm pad depth, arm pad side to side and pivot. This is an excellent ergonomic task chair for executives or workers.

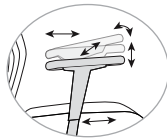

INSTRUCTIONS:

- Height: The arm adjusts up or down. To increase or decrease the arm height, press the button.
- Width: The arm adjusts side to side. To adjust the arm width, push down the lever located under the seat to unlock the width adjustment. Move the arm to the desired width and pull up on the lever to lock the arm in place.
- Arm pad depth: The arm pad slides forward or back.
- Arm pad side to side: The arm pad slides from side to side. Not to be confused with the arm width adjustment where the entire arm moves.
- Pivot: The armrest has three positions: 30-degrees in, center or 30-degrees out. To pivot the arm, grasp the arm pad and move it to one of the three positions.

Fully multi-adjustable (10-way) arms available exclusively on Focus.

MECHANISM FUNCTION GUIDE

SitOnIt Seating offers a wide range of function levels on our seating products. The descriptions and illustrations below are designed to introduce you to these mechanical functions and their primary advantages.

Standard Synchro (F)

Use for a variety of task environments. This 1.5:1 ratio synchro offers simple features for the budget-conscious buyer.

FEATURES

- Swivels 360°
- Gas cylinder seat height adjustment
- 1.5:1 seat to back synchronized recline movement
- Upright two-position tilt lock
- Tilt tension control
- Anti-kick feature
- Optional seat-depth adjustment on some models

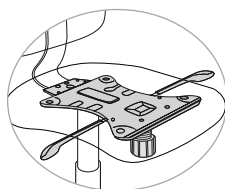

Standard synchro mechanism available on Hexy, Knack, Novo and Wit.

Enhanced Synchro (Y)

Use for a variety of task positions and extended hours of usage. This 2:1 ratio synchro offers smooth and easy-to-operate adjustments combined with maximum user comfort while ensuring correct posture and support. Allows for a full range of movement.

FEATURES

- Swivels 360°
- Gas cylinder seat-height adjustment
- 2:1 seat to back synchronized recline movement
- Upright two-position tilt lock
- Side tilt tension control
- Anti-kick feature

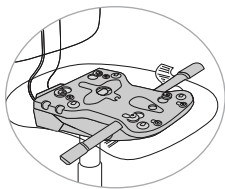

Internal back height adjustment not available on Focus and Prava.

Enhanced Synchro mechanism is available on Amplify, Focus, Focus 2.0, Glove Active, Knack, Prava, ReAlign, Sona, TR2 and Vectra.

Enhanced Synchro with Seat-Depth Adjustment (Y/E3)

Ideal for a variety of task positions and extended hours of usage.

This 2:1 ratio synchro offers smooth and easy-to-operate adjustments combined with maximum user comfort while ensuring correct posture and support. Allows for a full range of movement.

FEATURES

- Cable-driven control mechanism
- Swivels 360-degrees
- Gas cylinder seat height adjustment
- 2:1 seat to back synchronized movement
- Easy-to-adjust side activated tension control
- Upright two-position tilt lock
- Anti-kick feature
- Seat depth adjustment

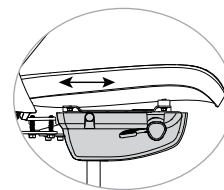

Enhanced Synchro with Seat Depth Adjustment is available on Amplify, Focus, Focus 2.0, Prava, Torsa and Vectra.

Internal back height adjustment not available on Focus and Prava.

Comfort Drive is available exclusively on Torsa.

Advanced Synchro with Seat-Depth Adjustment (L/E3)

Use for today's variety of task positions and usages. Discover easy, intuitive adjustments with easy-to-reach, rapid-adjust controls for ongoing ergonomic support/comfort.

- Rapid-adjust tension knob with five positive clicks; experience tightest to loosest tension in fewer than two turns
- Easy-to-adjust tilt limiter knob with positive clicks; enables tilt-limitation and continuous support in five positions up to 19°
- 2.3:1 ratio synchro
- Swivels 360-degrees
- Built-in seat depth adjustment lever

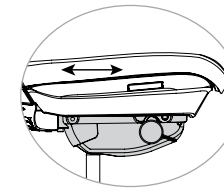

Advanced synchro mechanism available exclusively on Vectra.

MECHANISM FUNCTION GUIDE

Basic (Swivel Only) (B)

Use for short periods of time. Our most basic control has simple adjustments and works for casual meetings.

- Swivels 360-degrees
- Gas cylinder seat height

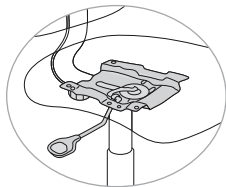

Basic mechanism is available on Anytime, Focus, InFlex, Non-Stop, Novo, OnCall, ReAlign, Relay, TR2 and Wit.

Swivel-Tilt (T)

Use for a variety of tasks and conferencing. Lean back and relax, or lock in the upright position and task with solid support.

- Swivels 360°
- Gas cylinder seat height
- Seat and back tilt as unit
- Tilt tension control
- Upright position tilt lock

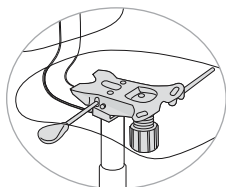

Swivel-tilt mechanism available on Knack, ReAlign and Sona. Swivel tilt mechanism is available on Focus, Focus 2.0, Glove Active, Glove Executive, Knack, Mavic, Non-Stop Heavy Duty, Novo, OnCall, Prava, ReAlign, Relay, Sona and TR2.

Knee Tilt (K)

Use for executive and managerial positions. The best of traditional tilt performance with a simple locking function. Allows for a full range of movement.

- Swivels 360°
- Gas cylinder seat height
- Seat and back tilt as unit
- Upright position tilt lock
- Tilt tension control
- Reduced rise on front seat edge

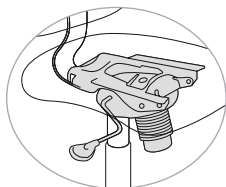

Knee-tilt is available on Focus, Glove Executive, Prava, ReAlign, Sona and TR2.

Posture Back (P)

Ideal for shared workstations. Perfect for limited task applications. Independent back articulation ideal for extended stool models.

- Swivels 360°
- Gas cylinder seat height
- Infinite back angle adjustment
- Optional seat-depth adjustment

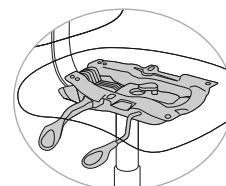

The posture back mechanism is available only on TR2.

Dual Torsion – Heavy Duty (DT)

Use for a variety of tasks and conferencing. Synchronized double-action rise allows full back recline for leg comfort and minimal front rise.

- Swivels 360-degrees
- Gas cylinder seat height
- Seat and back tilt as unit
- Upright position tilt lock
- Tilt tension control
- Reduced rise on front seat edge

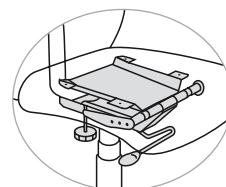

Dual torsion heavy duty mechanism available only on Non-Stop Heavy Duty.

Multi-Function (M)

Use for a variety of task positions and extended hours of usage. This control allows for an infinite range of movement and adjusts to a 5-degree forward tilt.

- Swivels 360°
- Gas cylinder seat height
- Infinite back angle adjustment
- Seat and back tilt as unit
- Infinite position tilt lock
- Free floats in unlocked position
- Tilt tension control
- Seat pivots in a 5° forward position
- Optional seat depth adjustment

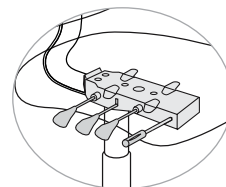

Non-Stop Heavy Duty models have a manual back height adjustment. Multi-function mechanism available on Glove Active, Knack, ReAlign and TR2.

Weight-Activated (WA)

Let's replace it with: This control includes a weight-activated back recline tension control and a tilt-limiter function

- Height-adjustment
- Seat depth adjustment
- Recline tension override: if you need more or less tension than the one set by the mechanism automatically
- Tilt limiter sets how far the chair can be reclined

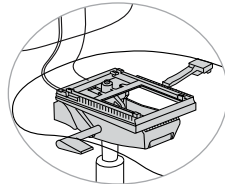

INSTRUCTIONS:

- Recline tilt limiter: The tilt limiter is integrated into the height-adjustment control. Pull the paddle all the way out to lock the chair to a fully upright position. The three grooves in the handle correspond to three tilt ranges. Push the paddle in and the mechanism will subtly click into the groove when adjusted, locking in the range.
- Recline tension override feature: Pull the control out of its stowed position and turn to your right (clockwise from seated position) to increase the amount of tension. The mechanism has a total range of 18 half-turns. The default setting is five half-turns, which is perfect for shared collaborative applications. For longer task applications, try three more halfturns to the right.
- Height-adjustment: Facing forward, the single control paddle is under the seat on the right. Pull up on the paddle to adjust. Stand slightly to raise the seat. Sit to lower the seat.
- Seat slider: While seated, locate the tab on the left side of the chair. Pull lever out to adjust the seat position. Slide seat forward or back to desired setting.

Weight-Activated mechanism available on Mavic.

EXECUTIVE AND CONFERENCE CHAIR OPTIONS

		GLOVE ACTIVE	GLOVE EXECUTIVE	HEXY	PRAVA	SONA	TR2 EXECUTIVE
BACK OPTIONS	Midback						
	Highback						
	Ballistic Nylon Back						
	Mesh Back						
	Plastic Back						
	Knit Back						
	Upholstered Back						
	Headrest						
	Pull Bar						
HD	Heavy Duty (350 lb)						
SEAT	+1" Seat Foam						
	Upholstered Seat						
MECH + SEAT ADJ	Enhanced Synchro						
	Multi-Function						
	Posture Back						
MECH	Enhanced Synchro						
	Basic						
	Swivel-Tilt						
	Knee-Tilt						
	Multi-Function						
	Posture Back						
FRAME	Black						
	Fog						
	White						

		GLOVE ACTIVE	GLOVE EXECUTIVE	HEXY	PRAVA	SONA	TR2 EXECUTIVE
FIXED ARMS	Armless						
	Fixed						
	Fixed Loop						
ARM ADJUSTMENT OPTIONS	Height						
	Height With Pivot						
	Multi (4-Way)						
	Multi (4-Way) With Pivot						
	Fully (6-Way)						
BASE OPTIONS	Black Nylon						
	Fog Nylon						
	Silver Metallic						
	White Nylon						
	Brushed Aluminum						
	Polished Aluminum						
	Higher Cylinder						

TASK CHAIR OPTIONS

		AMPLIFY	ANYTIME	FOCUS	FOCUS 2.0	HEXY	INFLEX	IONIQ	KNACK	LUMIN	MAVIC	MOVI	NON-STOP	NOVO	ONCALL	ORBIX	REALIGN	RELAY	RIO	TORSA	TR2	VECTRA	WIT	
BACK OPTIONS	Midback																							
	Highback																							
	Ballistic Nylon Back																							
	Mesh Back																							
	Plastic Back																							
	Thintex Back																							
	Upholstered Back																							
	Adjustable Lumbar																							
HD SERIES	Heavy Duty (350 lb)																							
	Large and Tall (400 lb)																							
	Extra Large (500 lb)																							
SEAT OPTIONS	+1" Seat Foam																							
	Large Seat Cushion																							
	Plastic Seat																							
	Upholstered Seat																							
MECH + SEAT-DEPTH ADJUSTMENT	Advanced Synchro																							
	Enhanced Synchro																							
	Standard Synchro																							
	Multi-Function																							
	Posture Back																							
MECH ADJUSTMENT NO SEAT ADJUSTMENT	Enhanced Synchro																							
	Standard Synchro																							
	Basic																							
	Swivel-Tilt																							
	Knee-Tilt																							
	Multi-Function																							
	Posture Back																							

TASK CHAIR OPTIONS (CONT.)

		AMPLIFY	ANYTIME	FOCUS	FOCUS 2.0	HEXY	INFLEX	IONIQ	KNACK	LUMIN	MAVIC	MOVI	NON-STOP	NOVO	ONCALL	ORBIX	REALIGN	RELAY	RIO	TORSA	TR2	VECTRA	WIT
FRAME OPTIONS	Accent Color																						
	Black																						
	Fog																						
	Graphite																						
	Silver																						
	White																						
FIXED ARM OPTIONS	Armless																						
	Fixed																						
	Fixed Loop																						
ARM ADJUSTMENT OPTIONS	Height																						
	Height With Pivot																						
	Multi (4-Way)																						
	Multi (4-Way) With Pivot																						
	Fully (6-Way)																						
	Fully (8-Way)																						
	Fully Multi (10-Way)																						
BASE OPTIONS	Black Nylon																						
	Fog Nylon																						
	Graphite Nylon																						
	Silver Nylon																						
	White Nylon																						
	Black Aluminum																						
	Brushed Aluminum																						
	Polished Aluminum																						
	Lower Cylinder																						
	Higher Cylinder																						

TASK STOOL OPTIONS

		AMPLIFY	ANYTIME	FOCUS	FOCUS 2.0	HEXY	INFLEX	KNACK	LUMIN	MOVI	NON-STOP	NOVO	ONCALL	ORBIX	REALIGN	RELAY	RIO	TR2	WIT
BACK OPTIONS	Midback																		
	Highback																		
	Ballistic Nylon Back																		
	Mesh Back																		
	Plastic Back																		
	Thintex Back																		
	Upholstered Back																		
	Adjustable Lumbar																		
HD	Heavy Duty (350 lb)																		
SEAT OPTIONS	+1" Seat Foam																		
	Plastic Seat																		
	Upholstered Seat																		
MECH	Basic																		
	Posture Back																		
FRAME OPTIONS	Black																		
	Fog																		
	Silver																		
	White																		
	Accent Color																		
FIXED ARM OPTIONS	Armless																		
	Fixed																		
	Fixed Loop																		
ARM ADJUSTMENT OPTIONS	Height																		
	Height With Pivot																		
	Multi (4-Way)																		
	Multi (4-Way) With Pivot																		
	Fully (6-Way)																		
	Fully Multi (10-Way)																		

TASK STOOL OPTIONS (CONT.)

		AMPLIFY	ANYTIME	FOCUS	FOCUS 2.0	HEXY	INFLEX	KNACK	LUMIN	MOVI	NON-STOP	NOVO	ONCALL	ORBIX	REALIGN	RELAY	RIO	TR2	WIT
BACK OPTIONS	Black Nylon																		
	Fog Nylon																		
	White Nylon																		
	Brushed Aluminum																		
	Polished Aluminum																		
	Stool Kit																		
	Extended Stool Kit																		

MULTIPURPOSE CHAIR OPTIONS

		ACHIEVE	ANYTIME	BAJA	CORA	FOCUS SIDE	FREELANCE	FREELANCE BARIATRIC	INFLEX	IONIQ GUEST	IONIQ SIDE	LUMIN	MIKA	MOVI	ONCALL	ORBIX	QWIZ	RELAY	RIO	ROWDY	SPROUT	WIT SIDE	
BACK OPTIONS	Ballistic Nylon Back																						
	Mesh Back																						
	Plastic Back																						
	Upholstered Back																						
	Wood Back																						
SEAT OPTIONS	Plastic Seat																						
	Upholstered Seat																						
	+1" Seat Foam																						
HD SERIES	Heavy Duty (350 lb)																						
	Bariatric (500 lb)																						
	Bariatric (600 lb)																						
	Bariatric (750 lb)																						
	Bariatric (1000 lb)																						
FRAME OPTIONS	4-Leg																						
	4-Star																						
	Wire Rod/Sled																						
	Nester																						
	Bisque																						
	Black																						
	Chrome																						
	Fog																						
	Polished Aluminum																						
	Silver																						
	White																						
OTHER OPTIONS	Book Rack																						
	Ganging Bracket																						
	Stacking Cart																						
ARM OPTIONS	Armless																						
	Fixed																						
	Fixed Loop																						
	Tablet Arm																						

MULTIPURPOSE STOOL OPTIONS

		ANYTIME	BAJA	FOCUS SIDE	FREELANCE	INFLEX	KICKSTAND	LUMIN	MIKA	ONCALL	ORBIX	RIO
BACK OPTIONS	Ballistic Nylon Back											
	Mesh Back											
	Plastic Back											
	Upholstered Back											
	Wood Back											
SEAT OPTIONS	Plastic Seat											
	Upholstered Seat											
	+1" Seat Foam											
FRAME OPTIONS	Bar Stool											
	Counter Stool											
	4-Leg											
	Wire Rod/Sled											
	Black											
	Chrome											
	Fog											
	Polished Aluminum											
	Silver											
ARM OPTIONS	Armless											
	Fixed											
	Fixed Loop											

PRODUCT CODE INDEX

Code	Product
CAM SN1 FS8	Cameo Single Seat With Dual Arms
CAM SN1 FS10	Cameo Single Seat With Right Arm
CAM SN1 FS12	Cameo Single Seat With Left Arm
CAM SN1 FS17	Cameo Single Seat Bench
CAM SN2 FS8	Cameo 2-Seater With Dual Arms
CAM SN2 FS10	Cameo 2-Seater With Right Arm
CAM SN2 FS12	Cameo 2-Seater With Left Arm
CAM SN2 FS17	Cameo 2-Seater Bench
CAM SN3 FS8	Cameo 3-Seater With Dual Arms
CAM SN3 FS10	Cameo 3-Seater With Right Arm
CAM SN3 FS12	Cameo 3-Seater With Left Arm
CAM SN3 FS17	Cameo 3-Seater Bench
CAMT TTL1	Cameo Inline Table
CAMT TTL4	Cameo Corner Table
CAMT TT8	Cameo Square Coffee Table
CAMT TT9	Cameo Rectangular Coffee Table
CP AS1 SN1	Composium Sharp Club Chair
CP AS1 SN2	Composium Sharp Settee
CP AS1 SN3	Composium Sharp Sofa
CP AS2 SN1	Composium Flair Club Chair
CP AS2 SN2	Composium Flair Settee
CP AS2 SN3	Composium Flair Sofa
CP AS3 SN1	Composium Curve Club Chair
CP AS3 SN2	Composium Curve Settee
CP AS3 SN3	Composium Curve Sofa
CP FS1	Composium Ottoman
CP FS2 SN1	Composium 1-Seat Bench
CP FS2 SN2	Composium 2-Seat Bench
CP FS2 SN3	Composium 3-Seat Bench
ENV BH4	Envoi Midback Lounge Chair
ENV BH5	Envoi Highback Lounge Chair
GBI BH4	Gobi Midback Lounge Chair
MCM TT1	Mezzanine End Table
MCM TT2	Mezzanine Coffee Table
MCM TT3	Mezzanine Corner Table
MCM TT4	Mezzanine Oval Occasional Table
MCM TT5	Mezzanine Rectangular Occasional Table
MCM TT6	Mezzanine Round Occasional Table
MCM TT8	Mezzanine Square Occasional Table
NNO FS13	Nano Triangle
NNO FS14	Nano Diamond
NNO FS15	Nano Trapezoid
NNO FS16	Nano Boomerang
PAS FS1 OS1	Paséa Mini Round Ottoman
PAS FS1 OS2	Paséa Large Round Ottoman

Code	Product
PAS FS1 OS3	Paséa Mini Square Ottoman
PAS FS1 OS4	Paséa Large Square Ottoman
PAS FS2 BNS1	Paséa Single Bench
PAS FS2 BNS2	Paséa 1.5 Bench
PAS FS2 BNS3	Paséa Right-Angled End Bench
PAS FS2 BNS4	Paséa Left-Angled End Bench
PAS FS2 BNS5	Paséa 90-Degree Corner Bench
PAS FS2 BNS5	Paséa 120-Degree Bench
PAS FS17 SS1	Paséa Single Seat
PAS FS17 SS2	Paséa 1.5 Seat
PAS FS17 SS5	Paséa 90-Degree Corner Seat
PAS FS17 SS3	Paséa 120-Degree Inner Seat
PAS FS17 SS4	Paséa 120-Degree Outer Seat
PAS FS18 BNS1	Paséa 27" x 27" Table
PAS FS18 BNS5	Paséa 90-Degree Corner Table
PAS FS18 BNS7	Paséa 13" x 27" Table
VRC SN2	Aviera Pre-Configured 2-Seat
VRC SN3	Aviera Pre-Configured 3-Seat
VRG	Aviera Guest and Bariatric Seating
VRG FS3	Aviera Hip Chair
VRG SN2	Aviera Freespan 2-Seat
VRG SN3	Aviera Freespan 3-Seat
VRL TTL1	Aviera Center Linking Table
VRL TTL3	Aviera End Linking Table
VRL TTL4	Aviera Round 90-Degree Linking Table
VRL TTL5	Aviera Square 90-Degree Linking Table
VRM FS4	Aviera Tandem Seating: Start
VRM FS5	Aviera Tandem Seating: Center
VRM FS6	Aviera Tandem Seating: End
VRP	Aviera Patient Seating
VS	Visit Modular Armless Club Chair
VS FS1	Visit Modular Ottoman
VS FS8	Visit Modular Club Chair With Arms
VS FS10	Visit Modular Club Chair With Right Arm Only
VS FS12	Visit Modular Club Chair With Left Arm Only
40	TR2 Task Chair
40E	TR2 Executive Chair
40 S1/S2	TR2 Task Stool
90	OnCall Wire Rod Chair
90 S2	OnCall Wire Rod Bar Stool
90T	OnCall Light Task Chair
90T S1/S2	OnCall Light Task Stool
91	Achieve Multipurpose Chair
92	Rowdy Wire Rod Chair
93	Anytime Multipurpose Chair

PRODUCT CODE INDEX

Code	Product
93 S2	Anytime Multipurpose Bar Stool
93T	Anytime Light Task Chair
93T S1/S2	Anytime Light Task Stools
94F	Relay Nester Chair
94T	Relay Light Task Chair
94T S1/S2	Relay Light Task Stool
671	Non-Stop Heavy Duty Task Stool
673	Non-Stop Heavy Duty Task Chair
681	ReAlign Midback Task Chair
682	ReAlign Highback Task Chair
971/974	Inflex Multipurpose Chair
971 S2	Inflex Multipurpose Bar Stool
971 S9	Inflex Multipurpose Counter Stool
973B	Inflex Light Task Chair
973B S1/S2	Inflex Light Task Stool
1011 FT1	Lumin 4-Leg Multipurpose Chair
1011 FT1 S2	Lumin Multipurpose Bar Stool
1011 FT1 S9	Lumin Multipurpose Counter Stool
1011 FT2	Lumin Wire Rod Multipurpose Chair
1012 FT3	Lumin Light Task Chair
1012 FT3 S21/S22	Lumin Light Task Stool
1051 FT1	Rio 4-Leg Multipurpose Chair
1051 FT1 S2	Rio Multipurpose Bar Stool
1051 FT1 S9	Rio Multipurpose Counter Stool
1051 FT2	Rio Wire Rod Multipurpose Chair
1052 FT3	Rio Light Task Chair
1052 FT3 S21/S22	Rio Light Task Stool
1152 FT5	Ioniq Guest Chair
1073	Vectra Highback Task Chair
1033 BK1	Novo Mesh Midback Task Chair
1033 BK2	Novo Mesh Highback Task Chair
1033 BK1 S1/S2	Novo Mesh Midback Task Stool
1061 FT4 MB	Movi Meshback Nester Chair
1062 FT3 MB	Movi Mesh Light Task Chair
1062 FT3 MB S21/S22	Movi Mesh Light Task Stool
1101 FT1	Mika 4-Leg Multipurpose Chair
1101 FT2	Mika Wire Rod Multipurpose Chair
1101 FT2 S2	Mika Wire Rod Bar Stool
1101 FT2 S9	Mika Wire Rod Counter Stool
1141 FT4	Qwiz Nester Chair
1113	Mavix Collaborative Chair
1123 BK1 MB	Focus 2.0 Mesh Midback Task Chair
1123 BK2 MB	Focus 2.0 Mesh Highback Task Chair
1123 BK1 MB S1/S2	Focus 2.0 Mesh Midback Task Stool
1131 FT2	Orbix Wire Rod Chair

Code	Product
1131 FT2 S2	Orbix Wire Rod Bar Stool
1132 FT3 CH1	Orbix Light Task Chair
1132 FT3 CH1 S21/S22	Orbix Light Task Stool
1152 FT1	Ioniq Side Chair
1152 FT3	Ioniq Collaborative Chair
1167	Kickstand Sit-to-Stand Stool
1171 FT1	Baja 4-Leg Multipurpose Chair
1171 FT2	Baja Multipurpose Wire Rod Chair
1171 FT2 S2	Baja 30" Wire Rod Bar Stool
1181	Sprout Wire Rod Multipurpose Chair
1191 SW19	Cora Multipurpose Guest Chair
1191 SW26	Cora Midsize Guest Chair
1191 SW30	Cora Bariatric Chair
1191 SW19 S2	Cora Bar Stool
1191 SW19 S4	Cora Easy Access Hip Chair
1191 SW19 S9	Cora Counter Stool
1203 BK1	Hexy Mesh Midback Task Chair
1203 BK2	Hexy Mesh Highback Task Chair
1203 BK1 S1/S2	Hexy Mesh Midback Task Stools
2221 FT1 MB	Wit Mesh Side Chair
2221 FT1 TXB	Wit Thintex Side Chair
2222 B1	Wit Mesh Midback Task Chair
2222 B1 S1/S2	Wit Mesh Midback Task Stool
2222 B9	Wit Thintex Midback Task Chair
2222 B9 S1/S2	Wit Thintex Midback Task Stool
2223 B1	Wit Mesh Highback Task Chair
2223 B9	Wit Thintex Highback Task Chair
2722 B1	Amplify Mesh Midback Task Chair
2722 B1 S1/S2	Amplify Mesh Midback Task Stool
2723 B1	Amplify Mesh Highback Task Chair
2723 B3	Amplify Upholstered Highback Task Chair
3021/3022	Prise Fixed Benching
3061/3062	Ocala Fliptop Table
3090 DT101	Sector Worksurface Screen
3090 DT301	Doodle Worksurface Screen
3090 DT701	Motif Fabric Worksurface Screen
3092 DT701	Motif Fabric Mobile + Freestanding Screen
3092 DT101	Sector Acrylic Mobile + Freestanding Screen
3093 DT101	Sector Acrylic Modesty Screen
3093 DT501	Laminate Modesty Screen
3093 DT701	Motif Modesty Screen
3096 CRSC	Sector Acrylic Round Café Screen
3096 CSSC	Sector Acrylic Square Café Screen
3096 TFSC	Sector Acrylic Tri-Fold Screen
3096 TRSC	Sector Acrylic Transaction Screen

PRODUCT CODE INDEX

Code	Product
3101 MAT01	King Cobra Light Duty Single Screen Arm
3101 MAT02	King Cobra Heavy Duty Single Screen Arm
3101 MAT03	King Cobra Heavy Duty Dual Array
3101 MAT03	King Cobra Heavy Duty Dual Screen High Splitter
3111 MAT06	Unity G2 Single Screen Arm
3111 MAT07	Unity G2 Dual Screen Arm
3120	Hightide Sit-to-Stand
3130 PCC/PCU	Current Power Module
3130 PTC	EON Power Module
3140	Rhythm Lighting
3150	Mobile Pedestal
3151	Keyboard Tray
3152	Cable Caddy Wire Management
3153	Anti-Fatigue Mat
3154	Laptop Tray
3155	Pencil Storage
3156 CPUS1	CPU Storage Band
3156 CPUS3	CPU Under Desk/Wall Mount
3161/3162 TBT6	Switchback 2-Stage 2-Leg T-Leg HAT
3161/3162 TBT7	Switchback 3-Stage 2-Leg T-Leg HAT
3161/3162 TBT6C	Switchback 2-Stage 2-Leg C-Leg HAT
3161/3162 TBT7C	Switchback 3-Stage 2-Leg C-Leg HAT
3161/3162 TBT8C	Switchback 3-Stage 3-Leg C-Leg HAT
3210 MAT30	Mobio Single Pole Monitor Arm
3210 MAT31	Mobio Dual Pole Monitor Arm
3210 MAT32	Mobio Triple Pole Monitor Arm
3210 MAT33	Mobio Single Desk Monitor Arm
3210 MAT34	Mobio Dual Desk Monitor Arm
3210 MAT35	Mobio Heavy Duty Single Desk Monitor Arm
3210 MAT36	Mobio Heavy Duty Dual Desk Monitor Arm
3210 MAT37	Mobio Heavy Duty Dual Array Monitor Arm
3231/3232	Tensor Tables
3242	EBeam
3260	Uni Laptop Table
3271 TBT2	Parallon T-Leg Flip-Top Table
3271 TBT3	Parallon T-Leg Fixed Top Table
3271 TBT3C	Parallon C-Leg Fixed Top Table
3271 TBT4	Parallon X-Base Table
3271 TBT15	Parallon Disc-Base Table
3271 TBT16	Parallon Dual Disc-Base Table
3291/3292	HiQ HA Benching
3301 TBT6	Surge 2-Stage 2-Leg T-Leg HAT
3301 TBT6C	Surge 2-Stage 2-Leg C-Leg HAT
3323	Knack Upholstered Midback Task Chair
3323 S1/S2	Knack Upholstered Midback Task Stool

Code	Product
5213/5213/5214/5214	Freelance Multipurpose Chair
5214 S2	Freelance Multipurpose Bar Stool
5214 S9	Freelance Multipurpose Counter Stool
5314	Freelance Multipurpose Counter Stool
5414	Freelance 30" Bariatric Chair
5414	Freelance 42" Bariatric Chair
5622 B1	Focus Mesh Midback Task Chair
5623 B1	Focus Mesh Highback Task Chair
5622 B1 S1/S2	Focus Mesh Midback Task Stool
5623 B1 S1/S2	Focus Mesh Highback Task Stool
5622 B4	Focus Upholstered Midback Task Chair
5622 B4 S1/S2	Focus Upholstered Midback Task Stool
5623 B4	Focus Upholstered Highback Task Chair
5623 B4 S1/S2	Focus Upholstered Highback Task Stool
5641/5642/5651/5652	Focus Side Multipurpose Chair (Black/Silver)
5651/5652 S2	Focus Side Multipurpose Bar Stool
5651/5652 S9	Focus Side Multipurpose Counter Stool
5723 B7	Sona Knit Conference Chair
5723 B8	Sona Upholstered Conference Chair
6023	Torsa Mesh Task Chair
6422	Prava Midback Conference Chair
6423	Prava Highback Conference Chair
7531	Glove Active Midback Conference Chair
7532	Glove Active Midback Conference Chair
7541	Glove Executive Midback Conference Chair
7542	Glove Executive Midback Conference Chair